

Heinz Heinzmann

Nova Philosophia Naturalis

The Concept
of Reality

There is a sequel to this book:

The Structure of Reality

A corrected and expanded version of my view of gravity can be found in my paper:

Against Dark Matter - A New Theory of Gravitation

The *Origin of Everything* itself does not exist.
It is the sole *Non-contingent*.

For us it is the fundamental process
that permanently generates reality.

Contents:

Preface.....	11
<i>Brief Prologue</i>	20
Introduction.....	22
1. Do we need a New Understanding of Nature?.....	22
2. Announcements.....	34
Part One: Explanations and New Interpretations	41
1. Local Solution of the EPR-Paradox.....	42
1.1. Preliminary Notes.....	42
1.2. The 2-Photon Scenario; Derivation of Bell's Inequality.....	43
1.3. The Local Alternative, demonstrated by a Simple Example.....	47
1.4. The 2-Photon Scenario – Local Reconstruction of the QM-Predictions.....	50
1.5. Additional Notes.....	55
1.6. Why is Bell's Inequality not applicable here?.....	56
1.7. Summary, Closing.....	59
<i>Double Miracles</i>	62
2. New Interpretation and Explanation of Special Relativity.....	63
2.1. Introduction.....	63
2.2. Why does Nature conform to the spacetime Conditions determined by Light?.....	64
2.3. Einstein's Scenario.....	65
2.4. The second Scenario.....	69
2.5. The Answer.....	73
2.6. The short Path to Matter.....	75
2.7. Theory of Relativity without Relativity.....	77
2.8. Derivation of the Lorentz-Transformation.....	83
2.9. Additions.....	86
2.10. What has been achieved?.....	88
2.11. Some philosophical Remarks.....	90
The Problem of the Relation between Existence and Time in Physics.....	90

What is Time?.....	91
Substance or Form?.....	92
2.12. What remains open?.....	92
2.13. Michelson-Morley: The Overlooked Opportunity.....	94
3. Local and objective Interpretation of Quantum Theory.....	95
3.1. Preliminary Note.....	95
3.2. Introduction: two Examples.....	95
Paradox of the Two Paths.....	95
Double-Slit Experiment.....	99
3.3. Back to the Roots.....	101
3.4. The Photoelectric Effect.....	102
3.5. The Compton Effect.....	110
3.6. The Reduction of the Wave Function: what actually happens.....	116
3.7. The Reduction of the Wave Function: Generalization.....	125
3.8. The central Assumption of the local and objective Interpretation.....	129
3.9. Objections.....	130
3.10. Explanation of Uncertainty; Interpretation of the Formalism	135
3.11. Implementation.....	142
Electron in the Box.....	142
Schrödinger's Cat.....	143
EPR-Paradox.....	143
Computer Simulation.....	150
Notes.....	152
Paradox of the Two Ways.....	155
Interaction-free Measurements.....	157
3.12. Historical Remark.....	161
3.13. Conclusion.....	162
<i>Everything is going to be alright!</i>	166
4. Concluding Remarks	169
4.1. Brief Summary.....	169
4.2. Contradiction to the Standard Model.....	171
4.3. Hidden Ontology.....	174
4.4. Outlook.....	176
Epilogue.....	180

<i>Open Letter on the Status of the Global Civilization</i>	182
Part Two: Physics from Metaphysics; The Elementary Concept of Reality	184
<i>Attunement</i>	185
1. The Primal Ground of Reality.....	186
1.1. Announcements.....	186
1.2. Criticism of modular Universes.....	188
1.3. Why there is Anything and not Nothing; The Origin of Everything.....	191
Preparation: the Difference between Reality and Description.....	191
The Search for the Origin.....	193
Explanations, Additions.....	195
Minimal Positive Metaphysics.....	198
The Connection with the First Part.....	200
1.4. What is that which exists? – The first Proposition; The first Equation.....	200
1.5. Waves.....	206
1.6. Notes.....	209
Short Summary.....	209
Relativity.....	210
The Role of Mathematics	213
Scale and Motion.....	214
On the first Law.....	214
2. Gravitation.....	216
2.1. The metric-dynamic View of Newton's Approximation.....	216
2.2. The exact View from outside; some simple Calculations.....	219
Closed circular Path of the Light.....	220
Perihelion Precession.....	222
Light Deviation.....	224
2.3. The Transition to the Metric View.....	225
2.4. The Transition to Einstein's Gravity: The Schwarzschild-Metric.....	228
2.5. Summary, Additions.....	231
The universal Flow-Field.....	233
The Choice of the Sign.....	236
The Area $r < m$	236

2.6. The hybrid System.....	238
2.7. Concluding Remarks.....	241
3. Antimatter.....	244
3.1. Matter and Antimatter as opposite metric Deformations.....	244
3.2. Gravitation in the Case of Antimatter.....	245
3.3. Asymmetry of Matter and Antimatter.....	252
3.4. Summary.....	254
4. Planck-Length, geometric Mass and Particle-Frequency.....	257
4.1. The metric dynamic Quantization Hypothesis.....	257
4.2. Phase Waves in the radial Flow; Connection between Mass and Frequency.....	258
5. Electromagnetism; Model of the Atomic Structure.....	265
5.1. Preliminary Note.....	265
5.2. Definition.....	266
5.3. The metric Flow that rotates around the Center.....	268
5.4. Positive and negative Charge.....	270
5.5. The Transition to an Observer System.....	271
5.6. The fundamental Difference between Gravitation and Electromagnetism.....	273
5.7. The Purpose of the subsequent Considerations.....	275
5.8. States of the Hydrogen Atom.....	276
The Ground State.....	279
The Frequency of the Ground State.....	283
The Spin in the metric dynamic System.....	284
Interpretation of the Spin.....	287
Excited States; Quantum Numbers.....	289
5.9. Atoms with Nuclear Charge Number $Z > 1$	298
5.10. Interpretation: What is an Electron Shell?.....	301
5.11. Closing.....	305
Notes.....	306
<i>Two Types of Mental Confusion</i>	308
6. A Universe without Mass.....	310
6.1. Preliminary Note.....	310
6.2. The Relation between metric-dynamic Physics and Standard-Physics.....	311
6.3. On the Comprehensibility of physical Concepts and Relations.....	315

7. Notes, Questions.....	319
The four Interactions.....	319
From both Sides.....	321
What are Material Objects?.....	322
A basic Principle of Physical Reasoning.....	322
8. Cosmology.....	325
Dark Energy.....	332
An alternative Story of the Cosmos.....	336
Dark Matter.....	337
Comparison.....	339
Summary.....	340
9. Propositions.....	342
<i>Zeitgeist-Musical</i>	347
Part Three: Mind and Matter; The Complete Concept of Reality.....	351
<i>The Visit of the Devil</i>	352
1. Why do Laws of Nature exist?.....	355
1.1. Preliminary Note.....	355
1.2. The Problem.....	355
1.3. A Contradiction as Starting Point.....	361
1.4. The Origin of the Laws of Nature.....	362
Notes.....	370
1.5. Consequences.....	372
The Abolition of the Separation of Space and Matter.....	372
The Impossibility of Reversing the Direction of Time.....	373
1.6. Summary of the Relationship between Individual Case and Law.....	374
2. Mind and Matter: Preliminary Notes.....	378
2.1. Introduction: a fundamental Defect.....	378
2.2. Overview on the next Steps.....	384
Free Will and the Completeness Axiom of Science.....	385
The Problem of the Qualia.....	390

3. Free Will.....	393
3.1. Preparation: Justification of psychological and mental Concepts.....	393
3.2. The Path to the Reality of the Mind over seven Stages.....	396
3.3. The last Step: the Substantiation of Free Will.....	409
3.4. Organized States in Neuronal Networks; Universals as Attractors.....	413
3.5. Summary.....	420
Notes.....	423
Closing.....	425
4. The modified Picture of Reality.....	427
4.1. Preliminary Note.....	427
4.2. Free Will and Determinism.....	428
4.3. Why Nature is not an algorithmic System.....	431
Proposition.....	437
4.4. Causality top-down.....	440
4.5. On Order and Laws.....	443
4.6. Some Consequences.....	447
The Independence of global Parameters.....	447
Objects; Object-Attributes and Interactions.....	449
The Direction of Time as a fundamental Fact.....	450
Being as Attractor.....	451
The three Types of dynamical Laws.....	453
Possible Weakenings of the Conditions; the Issue of Discretization.....	454
Additions.....	455
4.7. The altered Picture of Reality in the Overview.....	457
An Aspect of physical, philosophical and religious Significance.....	460
Addition: Proof of the Impossibility of Time Reversal.....	461
5. Qualia.....	464
5.1. Introduction.....	464
Meaning.....	465
5.2. Insertion: strange Conjectures.....	465
5.3. Why Qualia are not contained in any Description	469
Once again: the Problem.....	469
Substance and Accident; the Essence of Being.....	469
The Answer.....	474
Proposition.....	476
5.4. The Transformation of Being from the material Thing to the Quale.....	476

First and Second Substance.....	476
The Reason for the Transformation.....	477
Proposition.....	484
Notes.....	485
5.5. Criterion for the Occurrence of Sensations	488
A simple additional Argument.....	490
5.6. Who or What has Sensations?	491
5.7. Attempt of a conceptual Approach to the Transformation of the Substance	492
5.8. Philosophical Zombies.....	497
5.9. Artificial Intelligence.....	498
Understanding.....	498
Why Computers cannot bring forth Mind; the formal Reason.....	500
Why Computers cannot bring forth Mind; the metaphysical Reason.....	508
5.10. The metaphysical Difference between Reality and Simulation.....	509
Proposition.....	510
Corollary.....	511
6. Reality and Mathematics.....	515
6.1. Introduction: The Connection between Reality and Mathematics.....	515
6.2. Short Excursus: the three Worlds	517
6.3. Which Kind of Existence have mathematical Objects and Theorems?.....	520
6.4. The Source of the General	524
6.5. The Origin of Reality and of Mathematics.....	526
<i>Closing</i>	527
Summary	528
Post Script.....	579

Preface

Is the current theoretical physics just one equation away from perfection? Or are the hypotheses of superstrings, multi-dimensional branes, infinitely many bubble universes and dark energy rather to be seen as evidence of advanced disorientation?

I tend to the second assumption. The diagnosis is *loss of reality*, and the cure is not a new equation but *ontology*.

What does this mean? The following: In the development of physics, ontological questions – questions such as: *What is* an electron? *What* does it consist of? or: *Why* does mass curve the spacetime continuum? – have been dismissed and ontological principles have been ignored, and the current state of theoretical physics is the final result of these omissions.

In this book, I will present the type of physics that evolves if ontological considerations are included in the formation of physical hypotheses. In this way, an ontological structure unfolds by which the formal part of the most important physical theories can be derived and understood. The result is a kind of physics, which is *formally* identical or at least closely related with the prevailing physics, *conceptually*, however, completely different, because it is built upon an ontological basis.

Here, I will try to outline the main features of this process by going into the most important steps in the development of theoretical physics and taking into account ontological principles.

First to the ontological principles themselves:

(A1) On *existence*: Everything that exists exerts *effects*. (Something that does not interact with anything else does not exist.) Effects must emanate *from something*. So there must be a *carrier* of the effects. Carrier and effect cannot be separated from each other. (An example: the earth. It cannot be separated from its gravitation. It is there only *with* gravitation.) In the concept of existence, both – carrier and effect – are *inextricably linked* with each other. The carrier alone does not exist, the effect alone does not exist.

(A2) What exists claims its place in space and time exclusively for itself. Two entities cannot exist simultaneously at the same position.

(A3) If an object exerts an effect upon another – spatially distant – object, then this effect must be *mediated* by something, which means: something must *exist* by which this mediation is performed.

(A4) What is outside of space and time cannot be the cause of spatiotemporal changes.

Each hypothesis, which contradicts one of the ontological principles, is wrong.

Now to the implementation.

Newton's Theory of Gravitation contradicts (A3): it lacks the mediating element. An effect that acts across the empty Newtonian space is impossible. Therefore the theory is wrong. Why is it still so successful? Because *formally* it is an approximation of a theory in which the ontological contradiction is eliminated: *Einstein's* Theory of General Relativity. Here, *space and time* are the entities which perform the mediation: a differential spatiotemporal causal chain leads from the influencing object to the influenced object.

It is important to understand that – due to the act of assigning *change* to them – space and time themselves turn into *entities*, into something that *exists*. (Something which does not exist cannot change.) By this very act they are freed from their shadowy ontological status as *entia rationis* or *forms of perception* and raised to existence. Previously, they have been just the stage for the unfolding reality, but now they are themselves actors.

Maxwell's equations of the electromagnetic interaction produce waves – light waves. In the second half of the nineteenth century, it was presupposed that these light waves need a medium for their propagation, the so-called *ether*. At the end of this century, the ether-hypothesis was considered to be secure knowledge. (Maxwell himself tried for many years to derive his equations from the dynamics of the ether.) However, the certainty that the ether exists was eventually put into question by the fact that the measured value of the light speed was always identical, independently of the motion of the earth relative to the postulated ether.

In his Theory of Special Relativity, Einstein abandoned the ether. "Ether waves" turned into electromagnetic waves, periodic alterations of the amplitudes of an ether-oscillation became periodic alterations of the values of the electric and magnetic fields.

Now something of fundamental importance must be noted:

1. What is a *field*? The assignment of numbers to spacetime points. These numbers express the strength (and direction) of the effect of the field in the respective point. This means: the field represents *only the effect*.

Therefore, according to (A1) applies:

S1: A physical field is an instrument of description, but it *does not exist*: Existence can be assigned to it only in connection with its *carrier*, with which it is *inextricably linked*. According to (A3), however, electromagnetism needs something *existing* for its mediation. Therefore, the medium of the light waves is only *formally* superfluous, *ontologically*, however, it is necessary. The carrier cannot simply be replaced by the effect that emanates from it. From an ontological point of view, the abandonment of the medium is not permitted.

2. *Spacetime* is the medium that transports gravitation. Therefore it *exists*. From the fact that space and time are themselves entities, the following conclusions can be drawn:

According to (A3), all interactions require a medium for their transport. This medium, however, cannot be something that *fills* the space, as was assumed of the ether. With Newton's empty space, this would have been possible, after space has risen to existence, however, it is ontologically wrong: According to (A2), nothing can exist where already something exists. But space exists *everywhere*, and for this reason there cannot be any further entity by which another effect between objects is mediated.

From this follows:

S2: *Any* interaction is mediated by *spacetime*. Any field must be defined by alterations of spacetime.

So the medium of electromagnetism is also spacetime. (In the current theory of the electromagnetic interaction, this is not the case. I will come back to this further below.)

3. Let us now look at *elementary objects*. They *exist*, and therefore applies, according to (A2): Wherever they are, nothing else can be at the same time. This is also true for space and time, which exist too.

This means: Where an object is, there cannot be spacetime. Thus space and time exist *outside* of objects, and objects exist outside of space and time. With this, however, we have arrived at a contradiction with (A4): Something which is *outside* of time, cannot exert effects on something which

is *in* the time. The spatiotemporal causal chain, which is required for the transport of an interaction, cannot begin at something which is without time.

But if an object – as cause of spatiotemporal changes – cannot be outside of space and time, then it must be a *part* of spacetime, it must *consist* of space and time.

Therefore, objects are *states of spacetime*.

S3: Objects are stationary (or approximately stationary) states of spacetime. From this follows: they are *attractors* of the dynamics of the spacetime continuum.

Thus attributes of objects – like *mass* or *charge* – can be reduced to alterations of spacetime.

From S1, S2 and S3, the following proposition ensues:

(S) There is nothing but spacetime. Every object, every interaction, every process – in short, *everything* is change of space and time. This is the ontological basis from which the theoretical physics has to proceed.¹

What kind of physics arises from this basis? Although the previous conclusions seem to contradict many assumptions which are held for granted in the new physics, it is still largely the same physics. In this short preface, however, I can give only some hints to the required trains of thought – the detailed presentation remains reserved to the respective chapters of the book.

The *Special Theory of Relativity* follows almost immediately from (S). The way is to first separate space and time and to assume only a space-continuum. In this continuum, there are then only waves with light speed. Other velocities must therefore be considered as superpositions of waves with light speed. From these assumptions, Lorentz transformation and Minkowski space can be derived.

For the description of *gravitation*, it is necessary to attribute to the spatial continuum *local metric changes* of the *length* (changes of the length measure), which cause *longitudinal metric flows*. These flows *are* gravitation. Again, as in the case of special relativity, space and time are at first separated – *in* the flow, the time is always constant – and only due to the transition from a local to a global view the local time changes according to the General Theory of Relativity.

¹ In order to advance to the foundation of reality and its description, it is actually necessary to go a step further. But this cannot be discussed here.

Mass is a local metric length-deformation, which – provided there is no disturbance – causes a steady, accelerated metric flow directed towards the mass. Here, the results correspond with those of the Theory of General Relativity.

Matter and *antimatter* are opposite metric deformations. In the case of matter, the metric flow is real, in the case of antimatter, it is imaginary.

The *electromagnetic interaction* follows from *local metric changes of the angle* (changes of the angle measure), which cause *transversal metric flows*.

Electric charge is a local metric angle-deformation that causes a stationary, rotating metric flow around the charged object.

Positive and *negative charge* are opposite metric deformations. In the case of positive charge, the metric flow is real, in the case of negative charge, it is imaginary.

The strength of gravitation depends in the same degree on the causing length deformation as the strength of electromagnetism on the causing angle deformation. In this sense, both interactions are therefore equally strong. However, as the two deformations differ by more than 40 orders of magnitude in electrically charged elementary objects, gravitation and electromagnetism remain separated in virtually all real situations.

What about the *quantum mechanical* revolution, by which physics has been fundamentally transformed in the early decades of the twentieth century?

Again, the hypothesis (S) proves itself in the following way:

From (S) ensues that the world is a *world of waves*. Based on this assumption, the fact of a fundamental quantization of reality can be understood and derived. The structure of the quantum mechanical formalism becomes ontologically evident. The non-local correlations between spatially separated systems, which have already been considered a proven fact, turn out to be artifacts of wrong presuppositions.

In short: (S) permits a *local and objective interpretation of Quantum Theory*.

The list of changes of existing and derivations of new physical hypotheses based on (S) could be continued much further. But since it is not about completeness here, I will stop at this point and turn to the second subject of the book instead:

On our path to knowledge, we are always in an epistemological circle. We set up hypotheses and test them by comparing them with the reality. Either the reality confirms our hypotheses – within the measurement accuracy – or it opposes them. If the latter is the case, then we have to revise the respective hypothesis or try it with another one. *Validation* is the criterion by which the scientific kind of hypothesis-formation differs from other ones. Natural science owes its enormous theoretical and technical success to this criterion.

This thought can be generalized. Science cannot be limited to purely specialist questions. It replaces other explanation systems – for example religious or esoteric ones – and becomes the basis of a worldview. What has just been said about individual hypotheses applies also to this worldview: either our understanding of the world proves viable – which means: in its comprehensive application no incorrigible explanation gaps and contradictions occur –, or the reality turns out to be resistive by confronting us with problems that defy our attempts at explanation. Then we have to revise our view of reality or try it with another one.

There are indeed some questions, which elude an explanation based on natural science in its current form. The list of these questions is short, the questions themselves, however, are of utmost importance. They read as follows:

Why is there something and not nothing?

What is being?

What is the origin of the General?

Why are there laws of nature? (The so-called "induction problem")

How is sensation possible? (The problem of the "qualia")

Does free will exist?

(There are several other questions which at present cannot be fully answered due to the limitations of our knowledge. One of these is the question of how life arises. Also our knowledge of self-organization, evolution and ontogeny is restricted. In all these cases, however, we can fill in the gaps with scientific hypotheses, and the problems do not appear as insurmountable obstacles on principle but merely as technical difficulties.)

In science, the existence of laws of nature is indeed taken for granted, but it cannot be justified. The origin of the General is completely unclear. The existence of qualia even seems to point to a fundamental incompleteness of the scientific worldview: This view includes only information processing – the jump from information processing to a quale remains completely incomprehensible. For the hope of the engineers of artificial intelligence, it would happen one day – so to speak *by itself* – as a result of increasing complexity of simulations of mind, there is no rational reason.

This means: As long as these problems are not resolved, we do not know to what extent we can trust the scientific worldview.

The current scientific view of reality provides no way to clarify the issues listed above. However, if one starts from the previously outlined kind of science – the science that is built on an ontological basis –, then all these questions can be solved.

One of the questions has already been answered in this preface – the question: What is being? The answer was: Everything that exists is change of space and time. Every object is an attractor of the continuum dynamics, a pattern of spacetime changes that preserves its form over time.

I cannot answer the other questions here – this will be done in full detail only in the book itself – but I can at least outline the basic ideas of the answers. The following considerations, however, are so reduced that they are probably more suited to arouse interest than to establish understanding.

Why is there anything and not nothing? Every being can be or not-be. However it can be shown that the *origin of everything* does neither exist nor not-exist. Its ontological status is thus neither being nor not-being, but *necessity* – simply because putting it aside mentally would mean to ascribe to it the ontological status *not-being*, which has just been excluded. Hence the origin of everything is necessary, and with it that what emanates from it, that is: being.

What is the origin of the General? The world consists exclusively of *individual cases*. But the validity of physical laws requires the existence of the *General* over these individual cases. Whence does it come? The answer is as follows: A necessary condition for the possibility to distinguish the Individual from the General, is the existence of scales, in other words: the definition of units. A necessary condition of scaling is the reference to being. (For example, the unit of length is defined by the wavelength of a material object.) Therefore, the origin of the General must lie *before* every being, i.e. where Individual and General are indistinguishable due to the lack of scales. Therefore, the *origin of everything* must also be the origin of the General.

Why are there laws of nature? Actually there is only one single law: the one that produces the reality. All other laws are derived from it. Why does this singular law exist? The answer follows from considerations on the origin of everything. However, these considerations cannot be shortened so far that they could find room here.

How is sensation possible? This can be derived from the difference between what the things are *in themselves* and what they are *for us*, i.e. from the difference between *reality* and *description of reality*, which has already been illustrated here using the example of the physical field: from really existing objects effects emanate, from objects in a description of reality no effects emanate. Real things are *active*, things in descriptions are *passive*. Now the following can be shown: As a consequence of the evolution of mind, the metaphysical quality *activity* of the things that belong to the physical reality transforms into the metaphysical quality *sensation*.

Does free will exist? Yes, it exists, and the proof can be outlined using an example which – despite its simplicity – is yet more than a metaphor, because it contains essential elements of the explanation.

Consider a vessel made of glass. When it is struck, then it vibrates and a tone can be heard. There is only one possible oscillation pattern, which *always* develops, regardless of how and where the vessel is struck. The movements of the constituents of the vessel – the glass molecules – are therefore determined by this pattern. Causality acts from the whole to the particular, from the vessel to its constituents, and not vice versa.

The same is true for a neuronal network that brings forth mind. The network contains a number of possible activity patterns and transitions between these patterns. The activities of the elements of the network – the neurons – are determined by these patterns and transitions. Causality acts from the whole to the particular, from the network to its components, and not vice versa.

Mental states, however, are nothing other than such activity patterns. Thus neuronal activities are determined by mental activities and not vice versa.

Now we need the following: The neuronal network is permanently altered by its own activity. Therefore, the rules change which the sequence of mental states obeys. In other words: the mental activity changes its own rules. However this means that, in the case of a decision, only by the decision-making process itself is determined what will happen. To the question of why a (sane) person has decided so and not otherwise, there is then only one permissible answer:

Because he/she wanted it that way.

That concludes this brief orientation. Finally, a list of the topics of the book.

It contains:

- the answer to the question of why anything exists at all
- the answer to the question of what that which exists *actually* is
- the derivation of the fundamental process that generates reality
- the clarification of the origin of the natural laws
- the *actual* explanation why reality is relativistic
- the local and objective interpretation of quantum theory
- the solution of the quantum mechanical paradoxes
- a *local* description of entangled photons
- the description of the *basic mechanism* of gravitation
- the elimination of the natural constant G (the gravitational constant)
- the description of the *basic mechanism* of electromagnetism
- the unification of gravitation and electromagnetism
- the geometric definition of antimatter
- the substantiation of the asymmetry between matter and antimatter
- the geometric explanation of the atomic structure
- a geometric substantiation of some important physical relations
- the explanation of dark matter
- the explanation of dark energy
- the explanation of the connection between Individual and General
- the solution of the induction problem
- the answer to the question of what mind is
- the description of matter and mind by one and the same concept of nature
- the substantiation of free will
- the explanation of qualia
- the explanation why information processing systems cannot produce mind
- the explanation why information processing systems cannot feel

Brief Prologue

The SPEAKER, THE TRUTH, the HOLY GHOSTS of Relativity and of Quantum Theory, I MYSELF.

The SPEAKER:

Is it not true that, in long bygone times – when you were still of tender age and rather simpleminded –, you longed for the day which would reveal to you what keeps the innermost core of the world together? The day when, at long last, you would have all the answers to the "why" and "what is" questions, and that not in the meaning of a necessary inference from mathematical relationships, but in the sense of a real *explanation*? To questions such as: What is energy? What is matter? What is mind? What is consciousness? Why is matter energy? Why is spacetime bent by matter? Why does time pass more slowly in moving systems? Why is there nothing faster than light? and to many others. And above all, however: What is the world? What does it consist of? Why, after all, does anything exist?

This day has now come.

And then, much later – long after it had become clear to you that this would never happen (you already were an initiate), didn't you sometimes hope (furtively) that the day would dawn when the possibility would open up that the world might perhaps just be local and that the effect at a distance would burst like a soap bubble, the day, that is, on which you would come to understand the meaning of the reduction of the wave function and the real nature of quantum objects so that you might forget your doubts in regard to the objective existence of the world and could once again rejoice in your real space-time life?

This day, too, has now come.

You are in luck. THE TRUTH, you see, does not show up on some old, yellowed slip of paper which only the little girl who has found it in the woods is able to read – and who, at that, speaks a language no one but herself is able to understand (which, admittedly, would be a much prettier story!).

And you are out of luck, as the way in which THE TRUTH in fact manifests itself will seem hardly less strange to you.

This is because it appears as an example of a species formerly held in high esteem but now virtually forgotten and altogether disdained: as logical reasoning about the world, which leads to a notional solution of some problem seen as a conceptual puzzle, to a graphically intelligible model – which however, as everyone knows, is impossible. Thanks to experimentally documented facts as well as to the fundamental physical theories based on them and verified thousands of times over, it has long ago become fully certain that our notions are applicable only to our sensorily accessible medium-sized world and are not suitable for describing anything that is very small or very large or very rapid, and that, therefore, images and conceptions – while being necessary auxiliaries – are basically erroneous.

THE TRUTH bids to appear on the stage. It is impeded by the HOLY GHOSTS of Relativity and of Quantum Theory, who imploringly cry out to the audience:

Thou shalt not make unto thee any graven image, or any likeness of any thing, and if, in spite of this injunction, you do, you will go blind!

But I say:

Do not fear! Do it clandestinely, but do it here and now: Violate the Holy Commandment one last and decisive time, and it is going to expire from this violation, and with it all of its attendants are going to perish, and your eyes will be opened!

The SPEAKER:

What do you risk, after all? Either you sacrifice a few hours to some screwball – which certainly is no great risk. Admittedly, it is quite a frequent risk. Still, this time it is a rather amusing screwball.

Or else you agree with him. Then, of course, physics would have erred, and so would you!

But you know, after all, that is impossible.



Introduction

1. Do we need a New Understanding of Nature?

*Historical remark; criticism of the status quo of physics and philosophy; listing of open questions and unsolved problems – however only of such which a solution will be proposed to in the following.*²

The basis of the currently prevailing view of nature is the assumption that everything which exists and which occurs can be traced back to the motion of elementary entities that interact with each other.

At the beginning of his famous "Lectures" (first passage of 1-2), Richard Feynman tells us:

"If, in some cataclysm, all of scientific knowledge were to be destroyed, and only one sentence passed on to the next generations of creatures, what statement would contain the most information in the fewest words? I believe it is the *atomic hypothesis* (or the *atomic fact*, or whatever you wish to call it) that *all things are made of atoms – little particles that move around in perpetual motion, attracting each other when they are a little distance apart, but repelling upon being squeezed into one another.*"

The past history of this conception of the world is quite a short story. Its inventors are Leucippus and Democritus. They thought the world as consisting of very small, changeless particles of different shape, moving permanently, without cause and forever.

Dynamics – the theory of the movement of objects – begins with Aristotle. He differentiates between two kinds of movement: Objects move either because they aim at their natural position, or because they are forced to move by an exterior cause that must directly touch them. When they have reached their natural position – the heavy things at the bottom, the light things above – and if no exterior force is acting on them, they remain at rest.

This gives rise to the question of why a stone that is thrown upwards is still moving upwards when it has left the hand. According to Aristotle the answer must be: Because the medium surrounding the stone – the air, which is set into motion by the movement of the arm – is continually acting on the stone, forcing it to move further.

² As regards any of the listed problems, I assume you will be profoundly convinced that there is no alternative to the current view. However in the course of my deliberations it will become apparent that this is not true. (As Sledge Hammer said before every disaster: "Trust me, I know what I'm doing.")

However the air seems all too thin to be qualified for exerting such a force on a comparatively heavy stone. (Try blowing.)

After quite a long time – in fact not before the Middle Ages – this contradiction led to the hypothesis that the cause for the continuous upward movement of the stone cannot be found in the movement of the air but has to be seen as an attribute of the stone itself: the throwing motion provides the stone with a so-called *impetus* (a predecessor of the modern momentum), which is driving the stone upwards while gradually weakening until it has completely dwindled away, leaving the stone again to its drive toward its natural position at the bottom, where at last it will come to rest.

The next step came from Galileo. He developed the concept of frictionless motion which never stops, that is: of *impetus* as a conserved quantity.

At last, Newton used this concept as basis of the general law of motion. It reads as follows:

"Every body persists in its state of being at rest or of moving uniformly straight forward, except insofar as it is compelled to change its state by force impressed."

Thus force is no more necessary for maintaining motion but for changing it, and therefore it holds that:

"The change of momentum of a body is proportional to the impulse impressed on the body, and happens along the straight line on which that impulse is impressed."

In the formulation of Leonhard Euler: $\mathbf{F} = M \mathbf{a}$ (Force equals mass times acceleration), or, in differential notation: $\mathbf{F} = d(M\mathbf{v})/dt$.

Together with the assumption that every object is not only driven by exterior forces but is itself also in any case the source of a force, which means that every object that exists interacts with other objects, this law still represents – in spite of relativistic and quantum-mechanic modifications and additions – the basis of contemporary physics.

In this way it becomes the starting point of an almost unbelievable success. The present knowledge about nature allows us insights in all areas of reality, from the smallest to the greatest, and in the form of technology this knowledge has permeated all spheres of life and has changed the face of our planet.

Now the question is: If a concept is so overwhelmingly successful – does that mean it is also true? As we have learned from examples in the history of physics, the answer is *no*.

Newton's theory of gravity for instance was enormously successful, but in spite of its success it was superseded by Einstein's General Theory of Relativity, whereby the conceptual basis has been completely modified: the attracting force between masses has been replaced by the curvature of the spacetime continuum.

So let us pose the question: *Is the conceptual basis of contemporary physics ultimately correct?*

At least there are some reasons to doubt this assumption. They can be divided into three groups:

1. The failure of any attempts to develop the foundations of physics beyond the standard model of particle physics.

In the last decades, the most important project of theoretical physics has been, and still is, the uniform description of the four fundamental interactions. Apparently it is possible to associate any of these interactions with a group structure. This suggests associating the desired unified interaction with a group that contains these four groups. The definiteness of the mathematical structure which the realization of this purpose leads to, has, for a long time, nurtured the hope that at the end of this way there might also be a definite, unique theory. This hope has not been fulfilled. In any case the mathematics of the unifying process involves additional, "rolled up" dimensions which the topology of the theory depends on. However this topology is by no means unique; for this reason (and for some other ones), the present superstring scenario allows for more than 10^{500} different theories.

Also the second objective, the reduction of the number of *free parameters*, has not been accomplished. On the contrary – the unification mechanism enforces the assumption of additional, unknown quantities, e.g. masses of new particles, and also in this case there is nothing but an uncertain hope that these new free parameters could eventually turn out to be the consequences of hitherto unknown mechanisms – maybe symmetry breakings.

Without any doubt this is very disappointing! Or is it? Surprisingly, in just the same way as it happens in stage plays or in novels, when the situation of the hero has become so desperate that the progress of the story cannot be maintained by reasonable actions – think for example of the passage in the novel "The Hitchhiker's Guide to the Galaxy", where the protagonists are thrown out from the spaceship of the Vogons into empty space –, also in the case of the superstring theory suddenly a saving *deus ex machina* appears. In "The Hitchhiker's Guide to the Galaxy", it is the spaceship "Heart of Gold" with its Infinite Improbability Drive, in the superstring scenario it is the *multiverse*, a combination of an infinite number of universes and chance. So even if superstring theory has fallen at the hurdle of deducing a unique theory, this combination assures that *every* universe, which corresponds to one of

the 10^{500} theories and, moreover, to *any* possible set of free parameters, is actually realized. Therefore from a – to put it mildly – very optimistic point of view one might say that superstring theory has reached its goal to explain *our* universe.

However with its special free parameters, which are very fine-tuned as regards the development of physical, chemical and biological structures, it is admittedly an extremely improbable universe. Still, there is no reason to be surprised that we live in such an improbable universe, because any such amazement immediately calms down at the so-called "anthropic principle": We don't need to be astonished, because if not everything were as it is, we would not exist at all. Therefore we *have to be* in such a universe.

Of course this is true, but only in the sense that the actual present allows to determine which past is possible, and not in the sense of an explanation, why our universe is as it is. We can find out the necessary conditions for the present, but the present is not the *explanation* for these conditions.³

It is important to see that the combination of chance and infinitely many possibilities is actually *never* an explanation; instead, in the game of cognition, it represents a universally applicable joker, just like the assumption of an almighty god: both are able to explain *anything*, which means they actually explain *nothing*. This can easily be proven by the following thought experiment: Let us assume there were no physical laws at all. Everything which happens occurs completely by chance. Still there must exist – as one of the infinitely many universes – our own universe; a universe, that is, where purely by chance everything up to now has happened *as if* the known laws of nature were in effect. Of course the probability is enormously high that at the next moment everything will disintegrate – however again we must not wonder about this unfathomable enduring improbability! As mentioned above: if not everything were as it is, we would not exist at all, and so on and so forth...

However this does not mean that the scenario of infinitely many universes and chance can be ruled out completely – but, as stated before, it would be a great disappointment if this were our *summa scientia*.

Does the answer to the question if the interactions can be unified on the path hitherto pursued actually relate to the conceptional fundament of physics? I think yes: *If* particles and interactions are in fact the

³ Currently some physicists consider the possibility of the generation of life in our universe actually as an explanation for the values of free parameters. (E.g. Steven Weinberg in *Anthropic bound on the cosmological constant*, Phys. Rev. Lett. **59**, 2607, 1987). One can hardly believe that, in this way, the *causa finalis* which stems from prescientific reasoning comes back to physics. Such assumptions should not be discussed as part of natural science but as psychological phenomena, as symptoms of failure, which illustrate in a dramatic manner the explanation crisis in modern physics.

basis of the description of nature, then everything else seems determined, in other words: then there is probably no alternative to the known proceedings.

2. *The accumulation of observational facts, the relationship of which to known physics is not clear.*

At present, 96 percent of what the universe contains is completely unknown. For 22 percent – the so-called *dark matter* – there are some candidates in various speculative concepts beyond the *standard model* of particle physics, however as regards the remaining 74 percent – the so-called *dark energy* – we are utterly ignorant.

Isn't this to be interpreted as evidence that the conceptual basis of physics and the models built upon it are challenged and called into question like never before? Wouldn't it be appropriate, in view of such a vast *terra incognita*, to ask anew the most general and most fundamental of all questions: *What is the world actually made of?*

In the framework of contemporary physical concepts, *dark matter* and *dark energy* are indispensable. Without them, neither the dynamics of the objects in the universe nor the history of the universe can be described. However the question arises how far such *ad hoc* concept formations are justifiable, which have only been created to fill out explanation holes and for which, in spite of extensive research, no physical habitat has been found up to now.

Shouldn't instead the alternative be considered that the correct answers lie out of the reach of our hitherto used concepts of matter, of gravity and of the cosmos and that this fact is only clouded by the two *dark concepts*?

3. *The total loss of understanding and insight as the downside of the formal and technical success.*

The reservations against the gravitational force assumed by Newton were at first directed at the fact that it was actually an *occult* force: it seems impossible that an object can attract another object through empty space. In this way, physics has been associated with unthinkable entities already from the very beginning. However in the following the success of the physical theories repressed all philosophical doubts from the awareness of physicists – to such an extent that Heinrich Hertz could write in the year 1889:⁴

⁴ Heinrich Hertz, *Die Prinzipien der Mechanik in neuem Zusammenhange dargestellt: Drei Beiträge (1891-1894)* (Ostwalds Klassiker der exakten Wissenschaften, Nr. 263) Reprint of the Edition Leipzig: Akademie Verlags-Gesellschaft Geest und Portig 1984, Thun, Frankfurt am Main 1996, S. 67.

"Wir machen uns innere Scheinbilder oder Symbole der äußeren Gegenstände, und zwar machen wir sie von solcher Art, dass die denknöwendigen Folgen der Bilder stets wieder die Bilder seien von den naturnöwendigen Folgen der abgebildeten Gegenstände. Damit diese Forderung überhaupt erfüllbar sei, müssen gewisse Übereinstimmungen vorhanden sein zwischen der Natur und unserem Geiste. Die Erfahrung lehrt uns, dass die Forderung erfüllbar ist und dass also solche Übereinstimmungen in der Tat bestehen."

("We make inner images or symbols of outer objects, and we make them in such a way that the logically necessary consequences of the images are again in any case the images of the naturally necessary consequences of the depicted objects. To satisfy this postulate, there must be certain correspondences between nature and our mind. Experience teaches us that the postulate can be satisfied and that such correspondences do indeed exist.")

Only a few years later, this optimistic view of the connection between nature and mind seemed to be falsified once and for all. Exactly those experimental observations which in the following led to the theory of special relativity and to quantum theory could not be transferred into logically necessary images. (E.g. the Michelson-Morley Experiment or the Photoelectric Effect.) This results in a change of the ontological status of physical concepts. According to the Theory of Relativity, light is no longer a wave but merely a phenomenon that satisfies a wave equation. Also the elucidation of the relationship between space and time, or matter and energy, must content itself with the reference to mathematics.

According to quantum mechanics, reality divides into two different parts: part 1 is what appears in our observations and measurements – this is the reality which we encounter in our everyday life and which we believe to understand intuitively. Part 2, which represents the *actual* – that is: *causative* – reality, is what occurs *between* observations – so to speak "behind the curtains". According to the contemporary understanding of quantum mechanics, there can be no longer any conceptual interpretation at all of the events between experimental input and output. They are not only invisible but also inconceivable. Equations turn into input-output relations, and the relationship between elements of the mathematical structure and elements of part 2 of reality remains unexplained.

There is also the problem of the transition between the two parts. Part 2, the hidden reality, cannot bring forth part 1, our well-known reality, until a sudden change occurs, an act hitherto not understood – the so-called *reduction of the wave function*. Though it is presupposed in quantum mechanics, the theory provides no information what it actually is. Up to now it remains a secret why and how it occurs.

Therefore the world turns into a kind of black box. As we cannot look into the box and as there is no rationally conceivable description of what happens within it, every attempt to interpret its contents must fail. It is no longer admissible to ask what happens in between two observations. Conceptual or pictorial cogitation is reduced to a mere heuristic function in the service of mathematics.

Examples which illustrate these circumstances – e.g. the "double slit experiment" – are not meant to provide any understanding of what actually happens but to demonstrate that it is inconceivable.

Let us again listen to Richard Feynman:

"I think it is safe to say that no one understands quantum mechanics. Do not keep saying to yourself, if you can possibly avoid it, 'but how can it be like that?' because you will go 'down the drain' into a blind alley from which nobody has yet escaped. Nobody knows how it can be like that." ⁵

Thus physics has dismissed the demand of enlightenment to understand the world, or, to put it correctly, it has failed completely. What remains are mathematical models that enable us to make probability statements about events. However our view of the world has already merged with physical modeling to such an extent that we regard the failure of reasoning and the disappearance of reality connected with it – if we notice it at all – as inevitable or even as a matter of course.

This is due to the fact that physics claims to be universally valid: Everything which happens must obey the laws of nature. Therefore it seems as if the physical description applied to the fundamental layer of reality. If this is true, then, however, there is no way to recover the world if it has slipped out of the physical concept formation.

The last and apparently decisive stroke against all attempts to describe the world in an understandable manner was performed by John Bell. In 1964 he succeeded in deducing an inequality⁶ from which follows – at least according to general conviction – that there is no possibility to reproduce the (experimentally verified) predictions of quantum mechanics on the basis of a local and objective theory.⁷

⁵ Richard Feynman, *The Character of Physical Law*, Penguin 1992, p. 129.

⁶ John Stewart Bell, *On the Einstein Podolsky Rosen Paradox*, Physics, 1, 195-200 (1964).

⁷ *Objective* means: things are as they are, independent of our existence and of our observations. *Local* means: an event can only be influenced by another event via a process the speed of which is not greater than that of light.

However "local und objective" are indispensable ingredients of "reasonable and conceivable". Thus it seems to be proven that it is impossible to represent the world by models which are compatible with our thinking.

In spite of the fundamental relevance that physics has with respect to our worldview, the question if we need a new understanding of nature cannot be answered within the realm of physics alone. So I shall now end my *lamento sulla fisica* and put this question into a philosophical context.

What is lacking in the contemporary understanding of nature? Which important questions remain unanswered? Which important problems are still unsolved?

Beyond the realm of natural science, the glamour of success fades away quite quickly and gives way to the dreary twilight of intellectual disaster and human deficiency. There is no answer to many central questions. Some of them are considered unanswerable – however apparently without sufficient reason, some are nearly forgotten, and some are clouded by terrible confusion.

Let us start at the very basis. In any case, the first question is:

Why is there anything at all and not just nothing?^{8 9}

Here, all we can find is absolute helplessness. The same applies to the following question:

What is that what exists? What does it ultimately consist of?

Everything that exists needs at least a material carrier. However even if it is identified with this carrier, any attempt to answer this question breaks down at the inaccessibility of physical concepts. For what *is* matter, what *is* energy? After the disappearance of the ostensible vividness which, at the beginning, seemed to be suggested by the simple designations, it is now completely clear to us that physical conceptions are just elements of a mathematical scheme. But the world is not just mathematics – it *exists!* Thus, ultimately we don't know about *anything* what it actually is. We don't know what *existence* is.

⁸ Sometimes one can hear that the *creatio ex nihilo* were a quantum jump out of nothing. This cannot be taken seriously: Quantum jumps occur in the quantum vacuum, not in *nothingness*, and the *nothingness* cannot simply be identified with the quantum vacuum.

⁹ I shall not discuss any religious ideas. After the elimination of psychological projections (fears, wishes, ideals, fantasies etc.), notions like "god" or specifications like "outside of space and time" are completely empty. There is no more to say to that.

In the case of entities that cannot be reduced to other, simpler entities – in other words: in the case of elementary entities – it remains also a secret *why* they are as they are. It cannot be asked: *Why* does an electron carry electric charge? *Why* does matter curve spacetime?

Indeed this seems to be true – put aside the aforementioned limitations which are imposed on any "what is" and "why" questions by the contemporary interpretations of relativity and of quantum theory – because these questions are limited by an *a priori* and, accordingly, insurmountable border: by the thinking scheme of *substance* and *accident*. As follows:

Everything which exists must necessarily be thought as consisting of *substance* and *accidents*.¹⁰ However physical descriptions and explanations can only act within the area of the accidents. As the accidents, however, are logically completely separated from the substance, the substance is never reached. From this follows that, in the case of elementary entities, we can never ask the "what is" question – this would precisely be the question about the substance – nor the "why" question, because that would mean understanding an attribute of an entity – an effect exerted by it – *out of the entity itself*, and that would require a logical connection between substance and accidents.¹¹

Let me give two examples. The question of what an electron *is* can only be answered by listing its attributes. The question of what it consists of – that is: what it actually *is* apart from these attributes – is senseless. *Why* it has these attributes, remains hidden.

Or consider the question "What is mass?" Again we can only answer by using the accident: mass exerts gravitation. In Newtonian physics, gravitation is an attracting force between masses. However *why* this force exists has to remain unanswered. General Relativity describes gravitation as curvature of spacetime. In this way it replaces the Newtonian action at a distance by a differential action. However it cannot explain either, *why* spacetime is curved by matter. This attribute (accident) of matter is completely separated from the notion of *mass itself* (from the substance). Therefore, gravitation – as well as any other interaction and any other (fundamental) physical circumstance – is a phenomenon which must simply be taken as a fact that cannot be explained any further.

This means: As long as we hold on to the idea that the world consists of elementary entities – which necessarily divide into substance and accidents –, we cannot know *what* the world is nor *why* it is as it is.

¹⁰ For the moment it is sufficient to understand "substance and accidents" as "thing with attributes".

¹¹ In the case of entities which are *not* elementary, a reductionistic answer can be given. E.g.: What is water? An aggregate of H₂O-molecules. In the case of elementary entities, there is no such possibility.

Another unsolved question is the one about the nature of time.

What is time?

We don't know what time actually is. In physics, time becomes spatialized. However by this very act the nature of time gets lost. If, as Albert Einstein in his late years, one understands reality as kind of a four-dimensional block, then one has to explain why *for us* the present is a permanently forward moving (hyper-)plane of this block, that is: why the time coordinate is not available for us in the same way as the three space coordinates. However such an explanation is not in sight.

Also the following two questions, with which we are occupied since Plato and Aristotle, are still waiting for answers.

What is the relationship between law and individual case?

It is easy to say that "the laws of nature apply" or that "anything which occurs obeys the physical laws". But *where* should these laws be? *How* should they act on that which occurs?

Obviously, already the idea alone that they do act somehow *on* an entity is so absurd that one seems to be forced to deny the laws – i.e. the *general* – any existence und to regard only the *individual* – that what happens in any given situation – as real. Then, however, it becomes already an unsolvable problem to reason why identical cases should have identical consequences¹², because in order to assume they are identical and must therefore be seen as *one and the same case*, there must be the *general* under which they can be subsumed.¹³ All of a sudden one feels thrown back into the medieval universals controversy while realizing at the same time that none of the two positions can be correct. Up to now, this problem – which, after all, concerns the core of any description of the world! – remains unsolved.

Can that what exists be divided infinitely or is there a limit of divisibility?

In modern physics, this question seems to be decided. However actually nobody believes seriously that the *standard model*, which contains quite a considerable number of indivisible entities, represents the ultimate description of nature. In fact this cannot be the case because its applicability is limited.

¹² Here, consequences can also mean *probability distributions*.

¹³ *One and the same case* would be precisely this general, from which would follow that all individual cases which correspond to it are also equal among themselves.

However, independently from this question and more generally spoken, does not everything that exists have to be *originated*? And, therefore, isn't it unsatisfactory to assume that the universe consists of elementary, unchangeable elements – just like a *building set*?

The last two points in my list of unsolved problems of our worldview are also the most significant ones, as they refer to our self-understanding:

What is mind?

At present, it is impossible to explain the emotional aspect of mental states, the fact that in our mind *information* is always accompanied by *feeling*. What *qualia* are – e.g. the perception *red*, or the sensation *pain* – is not contained in any description.

We could also ask:

How is it possible to think of mind and matter as elements of *one and the same* conception of the world, without depriving at least one of these two phenomena – both of which, after all, seem so familiar and intuitively understandable to us – of its very nature?

Is it actually possible to assume mind as an autonomous entity within a nature that seems completely determined by laws? Are mental processes *nothing but* neuronal processes? Does the fact that they are *qualia* not prove that they are *more than* that? However if this is indeed the case, how can they then be understood as *natural* phenomena? Or do we have to content ourselves with interpreting this problem – as Kant did – as a pure, unsolvable *antinomy*?

The last question is closely related to the previous one. Yet it deserves to be formulated separately:

Does free will exist?

Surely it is not necessary to emphasize that a worldview in which the last two questions cannot be cleared up suffers from a fundamental defect that must be corrected urgently. Otherwise it could happen that we incline – or even fall prey – to any peculiar irrationalisms, e.g. that we take ourselves for the zombies that we are in reductionistic or functionalistic explanations of mind, or that we try to remedy our ignorance through the assumption of immaterial entities.

With this, I shall end my catalogue of contemporary cognition deficiencies and finish with a short summary:

The great potential of the current scientific worldview is based on the underlying conception of reality as a building set that consists of interacting particles.

On the one hand, this conception enables us not only to describe many areas of reality with great accuracy but also to devise and construct new scenarios – all the astounding technical achievements originate from it.

However as magnificent the building set and the technical constructions based on it may be, as depressing are, on the other hand, its deficiencies:

The operations that can be executed with the basic elements of the building set are performed out of our sight within a *black box*. Though it is possible to assign to any input a specific set of output events together with the according probability distribution, it is outright impossible to conceive an idea of *how* the output develops from the input – to that what happens within the box cannot be assigned *existence* in the usual meaning. Reality is vanishing away.

Neither do we know how our universe has originated nor why it exists at all.

We do not know what it consists of and why it is as it is.

We are incapable of understanding the change of the essence of being that occurs in the evolution of nature to entities of ever more complexity. However at the known end of this evolutionary development we find ourselves, and this means that we have no concept of ourselves. We do not know who we are and what our status in the cosmos is.

However as we are a part of nature, the concept of ourselves *must* be contained in our understanding of nature. Yet this is not the case in our current view. Therefore, this view must be wrong or incomplete.

Surely we need a deeper and more comprehensive understanding of nature.

2. *Announcements*

Historical note; outline of the structure of the book; unsystematic remarks.

2300 years ago (!) Aristarchos of Samos explained many of the observable celestial phenomena – among them also the temporarily reverse motion of the planets the interpretation of which has caused so much difficulty within the geocentric system – in a simple geometric manner by the assumption that the earth circles around the sun annually and rotates around its own axis daily. Back then the objections were already the same as those brought up against Galileo approximately 1900 years later: Shouldn't the motion of the earth make itself felt? Wouldn't storms follow from it? Shouldn't objects fall to the ground angularly?

That's a beautiful and characteristic example for the fact that it is always simple geometric evidence which leads to the right way and ultimately wins through. Against it, any knowledge that appears ascertained within the horizon of the just prevailing worldview, in the course of time fades out to a mere prejudice.

Why do I mention this episode? Because I see myself in a similar position: in the following, I will present a new physical and philosophical view of nature based on simple, often geometric arguments, a view, in which all conclusions appear to be reasonable and evident, which, at that, provides a solution – or at least a clear suggestion for a solution – for all the questions and problems mentioned in the previous section, – which, however, contradicts present scientific doctrines in nearly every respect.

The path to this new understanding of nature divides into three parts:

The First Part is criticism and correction of the interpretation network of contemporary physics.

In the first decades after 1900, physics faced greater challenges than ever before. The supposedly secure foundations of the Newtonian description of nature began to falter, the relativistic and quantum mechanical revolution started. Right here, at this point of the historical development, there would have been the chance to deepen the knowledge of nature by recognizing the real context.

This opportunity has been lost. Although the physicists of that time succeeded in describing the crucial scenarios – like e.g. the Michelson-Morley experiment, or the double-slit experiment – in a formally correct way, all attempts to form an idea of what is *actually* going on came to naught. This means, however, that the *understanding* of relativistic and quantum-mechanical circumstances is still missing,

so that the entire interpretative connexion is misleading to this very day. This is the reason for interpretative lack of clarity, paradoxes and, quite generally, for the *vanishing of reality*.

The first necessary step to abolish the fatal consequences of this historical failure is to disprove the general conviction that the so-called EPR scenario¹⁴ cannot be described by a theory with solely local parameters, in other words: that the measurements on entangled Systems predicted by quantum theory and verified experimentally cannot be reproduced by any local theory.

Thus I show at first, using the example of entangled photons, that such a local theory does indeed exist, and explain why Bell's proof that seems to rule out this possibility does not apply in this case.

Then follows a new interpretation of special relativity, by which it is cleared up *why* nature obeys the spacetime measures determined by light signals. (Actually it is not a *new* interpretation, because the term "interpretation" is only justified if such an explanation is available. However as this has not been achieved up to now, my explanation of special relativity is in fact its *first* interpretation.) Here, special relativity follows from purely logical reasoning, without the use of the postulate of relativity or the postulate of the constancy of light speed for all uniformly moving observers. In this way, special relativity obtains the status of a fundamental ontological fact, independent of any kind of physics.

Thereafter the scenarios are discussed through which the mechanical concept of particles has been introduced into the description of radiation, which had previously been understood as a pure wave-phenomenon: the Photoelectric Effect and the Compton Effect.¹⁵ It turns out that in both cases a very simple alternative has been overlooked.

These alternative descriptions confirm the local model of the EPR scenario presented just before and lead directly to a local and objective interpretation of quantum theory, the basis of which is the explanation of the reduction of the wave function, that is: of the sudden jump from the realm of the interfering quantum mechanical wave-functions to the definite observable reality.

So this, put in a nutshell, is the character of the First Part of this treatise: it describes a logically possible branching off from the path which physics has set out at the beginning of the 20th century. The advantage of this new way is that locality and objectivity of the world are restored, and, at the

¹⁴ EPR stands for Einstein, Podolsky und Rosen, who put this scenario up for discussion. (*Can quantum-mechanical description of physical reality be considered complete?* Phys. Rev. 47, 777, 1935.)

¹⁵ Planck's description of the blackbody radiation relates only to the discreteness of the energy absorption of resonators brought into the radiation field and not to the discreteness of the radiation itself. Planck did initially not agree to Einstein's assumption of *light particles* in his description of the Photoelectric Effect.

same time, matters which so far used to be unexplained and indeed inexplicable, assume a simple, comprehensible form, and all paradoxes disappear.

Independently from each other, all explanations and conclusions of the first part are pointing decisively to *waves* as basis of the physical description of the world, whereas it proves impossible to understand *particles* as elementary entities. With this it becomes clear that the fundament of physics – that, as mentioned at the beginning, everything which exists and which occurs can be traced back to the motion of elementary entities which interact with each other – must be replaced by another principle.

In the Second Part, the structure of reality that follows from these preconditions is outlined, whereby however it is not necessary to draw on the conclusions of the First Part. Indeed they are verified, however the new reasoning is completely independent from the First Part – and, moreover, completely independent of all hitherto existing physics.

Thus it is truly a new start. So it is all the more surprising that, from this totally different starting point, already after a few logical steps yet again the great physical theories come in sight: The theories of special and of general relativity and quantum theory. However this applies only to the formal part of the theories – the interpretation changes fundamentally.

Without doubt you are asking yourselves in what a wondrous way these absurd sounding promises should be fulfilled. By what kind of method could that be achieved?

The method is, to say it in the shortest way, the derivation of physics from metaphysics.

At first, the difference between *reality* and *description of reality* is determined. From this follows a proposition which, brought into the form of an equation, seems to be qualified as the fundamental equation of physics. Among others, gravitation, electromagnetism and atomic structure follow almost directly, only with the aid of some additional geometric assumptions, from this equation which is of astounding simplicity.

Indeed I myself was quite surprised by the whole procedure. Though the metaphysical part of the train of thoughts seemed compelling to me, I would have regarded it as interesting at best, but basically as insignificant, if the path to physics was not so short.

The Second Part finishes with some consequences for cosmology that ensue from the hitherto achieved results.

In the Third Part, the three areas of reality,¹⁶ whose mutual relationship is completely unknown at present, are united by a single concept:

1. The area of the physical: the material world.
2. The area of the mental: the world of consciousness, of thoughts, feelings and perceptions.
3. The area of the discoveries and creations of mind, which also the Platonic world of mathematics and the laws of nature is a part of.

At the beginning the question of the connection between the material world and the law which it obeys is answered, and also the questions where this law comes from and how it can be justified, as it is not simply presented to us by nature but has to be discovered. These questions can be cleared up by resorting to realizations of the Second Part.

In order to unite the world of the mental states – the realm of mind – and the material world, a concept of existence must be developed that provides an understanding of the essential changing of the evolving being. This is achieved in two steps:

First it is demonstrated that causality is not only working "bottom-up" but reversely also "top-down". Accordingly complex, composite aggregates become *autonomous entities*. Mental states are such entities. In this way the self-dependency and dominance of the mind as well as the existence of free will can be substantiated.

A necessary precondition for the possibility of the existence of causality "top-down" is the change of the physical paradigm performed in the Second Part.

Finally, a short philosophical excursus leads to a complete concept of being, which comprises physical being *and* mental being *as quale*. Thus mind and matter are, at long last, united within a single model of reality that is built upon an (adjusted) scientific fundament.

The basis for the systematical clearing up of the relationship between the material world and the world of the discoveries and creations of mind has also been created in the Second Part: the difference between *objects of reality* and *objects of a description system* determined at the beginning of this part

¹⁶ Here I follow the classification of Karl Popper, in particular his discrimination between a mental state as a feeling and as part of a logical structure, i.e. between the emotional content and the information content of any mental state. (I will assign the term "quale" to the mental state *as a whole*.)

serves as demarcation criterion and permits to understand the ontological status of the entities of the two worlds.

So much for the preview of the following lines of thought. I shall close with a loose sequence of comments.

On the kind of transformation of the worldview. Every civilization has its own explanation of the world. However our own, physical explanation differs from all other ones by the fact that civilization-specific and therefore replaceable elements have been largely eliminated and substituted by verifiable hypotheses. The accuracy of the congruence with the observed reality is so high that contemporary physical theories cannot simply be replaced by other ones.

So how should such a fundamental change as just announced be possible?

The answer is that the conceptual fundament of the theories is by far less stable than their formal part. Already at the beginning, I mentioned as an example the change from Newton's theory of gravitation to that of Einstein. Formally, Newton's theory is an approximation of Einstein's – in this regard, therefore, the two theories are similar to each other. But with respect to the basic concepts, they are completely different. The concept of attraction between masses is replaced by the concept of curvature of spacetime.

The change that I propose alters the conceptual fundament of physics as a whole, in such a way that all physical concepts are reduced to one single concept and all physical circumstances are reduced to one single circumstance. With this, the interpretation of the theories changes essentially; however the formal part remains unchanged or at least almost unchanged.

On the realization. In most cases, I shall neither pursue any existing argumentation strategies nor relate to them. Therefore it is superfluous to discuss the relationship between my point of view and other ones.

I try to solve every problem with as few resources and tools as possible. This requires liberating the respective scenarios from their historically developed context and rebuilding their logical structure. Only in this way the wrong conceptual paths, which physics and philosophy have progressed along and which have rigidified themselves to such an extent that alternatives seem completely unthinkable, can be avoided.

As a matter of fact, the problems the solution of which we are targeting here are exactly the ones that could *not* be solved with the standard methods. Thus their unsolvability is to a certain extent also a

language problem. Accordingly I shall analyze these problems in general not by the terminology of the associated field. When I use philosophical concepts – for instance the concepts *substance* and *accident* in the Second Part and in the Third Part – I use them at first in a simpler and later also in a different sense as usual. It is absolutely imperative to read them as they are defined and used here and to leave behind all differentiations that they have undergone in the course of the centuries. Only in this way, by exactly this kind of application, they are powerful enough to solve the problems which will be described and analyzed by them.¹⁷

In the area of physics, it will turn out that in some cases – e.g. in the explanation what *actually* happens at the double slit experiment – the everyday language, augmented by a bit of mathematics, is more appropriate to solve the hitherto existing interpretation problems than the mathematical formalism. The reason for this is that the mathematical formalism has more and more assumed a separate existence and has absorbed the reality that was the reason for its creation. In order to renew the tension between this reality and the formalism, it is therefore inevitable to step out of the formalism and refer to the reality that lies behind it.

Reality and formalism. Reality is not a mathematical formalism. The idea, a planet would *calculate* its path is simply absurd; whatever happens is surely not a consequence of calculation.

But then – what does *actually* happen? *How* does it happen? *Why* does it happen? *By which circumstances* is a planet led on its path? And in general: *In which way* does the future evolve from the present, if it is not *calculated*?

These are the questions about the reality that lies "behind the formalism". They have almost completely disappeared from the awareness of the physicists. The answers to these questions, however, represent the actual goal of the search for knowledge of nature, and therefore they will be in the center of the following considerations.

On communication problems. Surely, the main problem is that hypotheses which relate to the conceptual foundations of physics, are at first unexplainable. For what means *explaining*? It means relating something unknown to something already known. However if just that which is already

¹⁷ It was with some reluctance that I decided to apply such historically grown concepts. However the only alternative, that is to invent new concepts, seemed even more problematic to me, especially because of the anyway existing congruities between my definitions and the usual meanings. After all it could be argued that, ultimately, they mean yet the same. Therefore I preferred to adopt the established concepts. At first it may seem that I just usurped them, but at the end, in achieving the desired explanations, it will turn out that it was a justified acquisition.

known is put into question, then this path to understanding, i.e. by explanation, is at first hardly possible. If exactly the known *explanantes* are indeed affected by the intended changes, then understanding presupposes to suspend – at least on trial – even the basis of the usual view.

However, at the end the conversion of the whole interpretation network is a question of immediate *seeing* – suddenly the perception toggles into a different state, as in an optical illusion, and the new shape becomes visible.

But enough with the preliminaries. Let us now proceed to the real thing.

Part One

Explanations and New Interpretations

Local and Objective Interpretation
of Quantum Theory

New Explanation of Relativity

1. Local Solution of the EPR-Paradox

1.1. Preliminary Notes

The EPR Paradox will be cleared up in two rounds. The first one is dedicated exclusively to the refutation of the conviction that it is impossible to reproduce the quantum mechanical predictions for measurements on entangled systems by a strictly local theory. To this effect it is sufficient to present such a theory – the physical implications resulting from it can be ignored for the moment. However after the interpretation of special relativity, the alternative description of the Photoelectric and the Compton Effect and the explanation of the reduction of the wave function, we will return to EPR. The local solution of the paradox will then be part of the new local and objective interpretation of quantum mechanics.

To understand what the paradox is about, only a few facts are needed:

1. Generally, the quantum mechanical description of an object determines for some attributes not a definite value but only the probability distribution of possible measurement values.
2. This applies also to the case of two spatially separated objects which interacted in the past or which originate from the decay of an object.
3. Between the outcomes of certain measurements on these two objects there will then be a connection that is called "entanglement". E.g. in the case of two identical particles A and B which come from the decay of an object at rest and depart into opposite directions, the measurement values of the two momentums are interconnected in the same way as in classical physics, which means that in any case $p_A = - p_B$. Another example: If a spin 0 system decays into two photons, then the measured polarization directions of the photons are rectangular to each other.

That's all there is to it! What is paradoxical about it? This is quickly explained too:

Let us assume as yet no measurement has been performed. Thus only the probability distribution of the measurement values is known. But if now the momentum of particle A is measured, then, because of (3), *at the same moment* also the momentum of B is known, and the same applies to the case of the photon polarizations.

Now one can argue with Einstein, Podolsky and Rosen in the following way:

B is at an arbitrarily great distance from A. Therefore, the measurement on A cannot have influenced B. Thus we can state: if B has a definite momentum *after* the measurement on A, then it must have had this momentum also already *before* the measurement on A – otherwise the measurement on A would have caused a change of the state of B. However, since the quantum mechanical description does not contain this momentum, it must be considered incomplete. (In this case, the momentum would be a so-called *hidden parameter*.)

That sounds like a reasonable argument! Indeed the alternative would be to assume a *non-local* connection between the two measurements, that is a connection which requires either a faster-than-light transmission or which exists without any mediating process at all and must simply be accepted as such.¹⁸

But now follows the paradox: Exactly this plausible EPR assumption – that the result of the measurement on B is already determined *before* the measurement on A, because it corresponds to an *objectively existing* attribute of a single system – is a necessary and sufficient condition for the derivation of Bell's Inequality, from which then follows that a local description of the world, which conforms to the experimentally verified predictions of quantum theory, is impossible. Hence, in the end, exactly the argument by which EPR meant to prove the incompleteness of quantum theory serves to reduce their own intention to absurdity, to describe the world in an objective and local way.

Thus the entanglement must in fact be understood as *non-local connection*. We seem to be compelled to resign ourselves to the non-locality of the world. At least this is the current state of affairs.

1.2. The 2-Photon Scenario; Derivation of Bell's Inequality

Let us now turn to the experimentally best tested case of entangled systems: a 2-photon system with total spin 0.

Let Z be a spin 0 system that decays into two photons:

¹⁸ The quantum mechanical formalism informs only about the measurement values which are to be expected, but it does not inform about *how* these values are realized or from which moment on the measurement value of B exists. However the possibility of a transmission the speed of which is not greater than that of light has been ruled out by experiment.

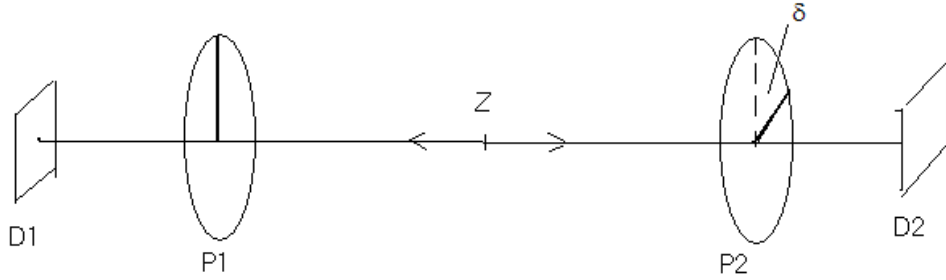

(S1)

P_1 and P_2 are polarizers; D_1 and D_2 are photon detectors. The plane of the right polarizer P_2 is turned by the angle δ against the plane of the left polarizer P_1 .

At first in short the Quantum mechanical description (however just for the sake of completeness; all which is in fact necessary for the following considerations is the value of the probability $W(\delta)$ in (2)).

The state vector of the two photons is

$$\Psi = \sqrt{\frac{1}{2}} (x_1 y_2 - x_2 y_1), \quad (1)$$

where x_1, y_1 and x_2, y_2 are the polarization states of the two photons with respect to any x- and y-axes. Expressed by trigonometric functions:

$$\Psi = \sqrt{\frac{1}{2}} (\cos \alpha \sin(\alpha - \delta) - \cos(\alpha - \delta) \sin \alpha) \quad (1')$$

For the probability $W(\delta)$ of the simultaneous reaction of both detectors holds

$$W(\delta) = \Psi^2 = \frac{1}{2} \sin^2 \delta. \quad (2)$$

Let us now look at an experiment performed with a series of such photon pairs.

There are two series of events: $\{EL\}$ (events left side) and $\{ER\}$ (events right side), both in any case with two possible values: 1 (photon) or -1 (no photon). The events are *polarization measurements*.

Before measurement – in the state described by equation (1) – the photons do *not* have a definite polarization, which is expressed by the fact that (1) is independent of the directions of the x- and y-axes, i.e. it is rotationally symmetric with respect to the propagation direction of the photons.

If now the polarization of a photon, say: the left one, is measured, then also the polarization of the right one is given. (E.g. if the left photon appears in the detector, its polarization must be parallel to the direction of the left polarizer; then it is known also without measurement that the polarization of the right one is orthogonal to this direction. Thus the probability of its appearance in the right detector will be $\sin^2\delta$.)

This is the starting point of the ***EPR argument***: In the quantum mechanical description, the right photon is – after the measurement of the left one – in a different state than before this measurement. However as it can be ruled out that the measurement of the left photon could *in fact* have changed the state of the – arbitrarily far away – right one, it must be assumed that the polarization of the right photon has already existed before this measurement. According to (1), however, there is no definite polarization before the measurement, therefore quantum mechanics is incomplete.

The ***EPR assumption*** that the attributes to be measured exist already before – which means: independent of – the measurement, is a necessary and sufficient condition for the derivation of ***Bell's Inequality***, for the following reason:

Any derivation of Bell's Inequality is based on statements about how the measurement objects of a certain experiment *would behave at other measurements* – in fact without such a statement the inequality couldn't even be noted down. For *entangled objects*, however, statements of this kind are not permitted, because these objects and their respective counterparts must be understood as *one single system*, and statements about their behavior at further measurements are thus impossible.

However, due to the EPR assumption it becomes possible to make such statements: If the objects are *separated* from each other and possess their attributes independently of measurement, then it is evidently also known which results other measurements on these objects would lead to.

This shall now be demonstrated by a variant of the inequality¹⁹ (originally introduced by Bernard d'Espagnat in 1979), adapted for our example:

¹⁹ I chose this variant because it can be understood without physical knowledge and because, with respect to my conclusions, it doesn't make any difference which variant of the inequality is used. The step which my argument refers to is *in any case* necessary for establishing the inequality. More to that follows in the text.

Let the hidden parameter be the polarization direction of the photons. Accordingly, each of the two photons possesses – independently of any measurement – a component 1 or 0 (that is: goes through the polarizer or does not go through) in every possible direction.

Let α be the angle of the left polarizer, γ the angle of the right one. Let $R(\alpha|\gamma)$ be the number of the cases in which at R measurements both detectors respond.

If both polarizers are adjusted at the same angle, then, because of (2), never both photons of a pair pass through but in any case either the left or the right one. Therefore $R(\alpha|\gamma)$ can be divided into $R(\alpha,\beta|\gamma)$ (this is the number of photons in $R(\alpha|\gamma)$ which *would* go through at a third angle β on the *left* side), and $R(\alpha|\beta,\gamma)$ (the number of photons in $R(\alpha|\gamma)$ which *would* go through at the same angle β on the *right* side):

$$R(\alpha|\gamma) = R(\alpha,\beta|\gamma) + R(\alpha|\beta,\gamma) \quad (3)$$

*This is the point where the EPR assumption comes into effect: The objects which were measured at the angles α and γ could not be measured additionally at the angle β , and in case of their entanglement the above conclusions would be prohibited. However, due to the EPR assumption it becomes possible to make statements about what would be the case if both polarizers were adjusted at the angle β and **the same photon pairs** as in the actually executed series were underway.*

Certainly is $R(\alpha,\beta|\gamma) \leq R(\beta|\gamma)$, since the number of photons which go through at the angle β cannot be smaller than the number of photons which would go through at β and at α . In the same way it is evident that $R(\alpha|\beta,\gamma) \leq R(\alpha|\beta)$. (Also for this step the EPR assumption is needed.)

With this, from (3) follows Bell's inequality:

$$R(\alpha|\gamma) \leq R(\alpha|\beta) + R(\beta|\gamma) \quad (4)$$

According to (2)
$$R(\alpha|\beta) = \frac{R}{2} \sin^2(\beta - \alpha) = \frac{R}{2} \sin^2 \delta$$

Let be $\alpha = 0^\circ$, $\beta = 22,5^\circ$, $\gamma = 45^\circ$. Then (4) turns into

$$0,5 \leq 0,1464 + 0,1464 \quad 0,5 \leq 0,293.$$

Thus Bell's inequality contradicts quantum mechanics. Experiments confirm quantum mechanics. This means: as regards the actual measurements, Bell's inequality does not hold true.

As seen above, however, apart from logic and mathematics (whose validity is presupposed), for the derivation of the inequality only two assumptions are needed: the entanglement condition (that is: with the same angle on both sides, exactly *one* photon at a time will appear) and the EPR assumption. The validity of the entanglement condition is proven experimentally. Hence from the falseness of the inequality follows the falseness of the EPR assumption, which means:

*Prior to the measurement of the one photon, the other photon does indeed **not** have a definite polarization. After this measurement, it **does** have a polarization. Therefore, the measurement of the one photon causes a change of the state of the other photon. There is in actual fact a non-local connection.*

So much for the chain of evidence that is considered safe and inevitable by almost all physicists

1.3. The Local Alternative, demonstrated by a Simple Example

If – as EPR assumed – the objects are *separated* from each other and possess their attributes independently of measurement, then it seems completely self-evident that the behavior of these objects at further measurements is known.

However, exactly this ostensible obviousness shall now be challenged. We will investigate, whether it is true that the assumption of separateness or locality (the EPR assumption) permits statements about further measurements on the same objects and, in this way, enables the derivation of Bell's Inequality.

To begin with, let us once again formulate the locality-assumption. It reads as follows:

A1: *The measurement on one side is independent of whether a measurement on the other side has been carried out or not. It is not influenced by this measurement.*

As discussed above, for the derivation of Bell's inequality (not only for the variant presented here but for all possible variants) the following assumption is required:

A2: *Statements about further measurements on the same objects are permitted.*

(The necessity of this assumption is obvious: As follows from the substantiation of equation (3), establishing the inequality involves statements about results of *various measurements on the same objects*. Therefore, without assumption **A2** the inequality could not be established.)

But I will now show: *A2 does **not** follow from A1.*

This means:

A1 is necessary, but not sufficient for A2. There must be a condition which is required for deducing the inequality but not for maintaining locality.

The following simple example will be sufficient to prove this assertion and to show at the same time what condition that is. In spite of its simplicity, it possesses all attributes needed for clearing up the issue.

Imagine a square room in the center of which is a bunch of balls that weigh 1, 2, 3 or 4 grams. Along the left and the right wall empty containers are positioned, 10 on each side. Under each container, there is a scale which emits a short tone, if, during a loading process, a limit of 5 grams or a multiple of 5 grams is reached or exceeded.

In the room is a person who performs *moves*. A move is defined as follows: To each of the two series of containers, balls with a total weight of 4 grams are distributed, i.e. 4 grams to the left and 4 grams to the right. (The symmetry of the weight distribution represents the entanglement condition.) The choice of the balls and of the containers is random. (With due regard to the 4g rule: e.g. after a 3g ball, only a 1g ball is possible.)

Each move entails a pair of *events* (event to the left and event to the right); each event has two possible values: *tone* or *no tone*. (The value *tone* can also consist of more than one tone.)

Evidently, here the connection between the objects and the measurement values is not as simple as in the EPR scenario: it is not the *object-attributes* themselves (the weights of the balls) which are measured, but the *effect of their accumulation*.

This circumstance is of decisive importance for the question of whether statements about further measurements on the same objects are possible, because in this case the events that follow from a move do not only depend on that move but also on the preceding moves.

E.g. let E1 und E2 be two measurement series with 50 moves each. Let us assume, the 38th move of E1 causes the event pair (*tone* | *no tone*).

Now, if any of the moves of E2 (except the first one) is replaced by this move, is then anything known about the event pair that will be caused by this move in E2?

The answer is no.²⁰ Whether the replaced move will cause a tone or not does not only depend on this move but also on how much weight has been in the containers already before this move. However that depends on the specific course of E2 which is most likely different from the course of E1 and completely unknown.

Therefore we can state: *The connection between a move and the following event pair is inseparably bound to the course of the respective measurement series.*

Every event pair does not only depend on the directly preceding move but also on all other previous moves. Therefore it is not possible to predict anything about what would be the case if a move was transferred from one experiment into another experiment.

With this, it is proven that the assumption A2 does not follow from the assumption A1. Though it is evident that, in our example, the event on one side is not influenced by the event on the other side, it is still impossible to predict anything about the events that would follow from a move of a certain experiment if it were transferred into another experiment.

In other words: *Statements about further measurements on the same objects are not permitted.*

So what is the condition which is necessary for deducing the inequality but not for ruling out non-locality? It is the assumption made by EPR that the measurement value is determined already before the measurement *because it corresponds to an objectively existing attribute of the measured object which this object possessed already before the measurement.*

But evidently, this assumption is not necessary for maintaining locality: Also in our simple example, every measurement value is determined already before the measurement, however not because it corresponds to an attribute of the measured object but *because it is generated by the measuring process – by the adding up of the weights of the balls and the acoustic signal caused by it – in a definite manner.*

Thus here the measurements are not performed on "objects" in the usual sense, which means: on "things" that persist "as themselves" or "identical with themselves" and which are therefore available for further measurements, but on varying aggregates of always new composition, and, moreover, the measurement result depends in any case also on the preceding course of the experiment.

²⁰ Of course with the exception of the general probability statement that follows from the consideration of all possible series. However this is irrelevant here.

Generally spoken: *The concepts "object" and "measurement process" are fundamentally changed.*

With this, we have shown that besides quantum mechanical standard interpretation and the interpretation of Einstein, Podolsky and Rosen, there is indeed another, *local* interpretation of the 2-photon scenario – provided it is possible to apply the scheme of the example to this scenario.

Thus if we succeed in transferring this scheme to the 2-photon scenario, then the consequence is that the condition which is necessary for the derivation of Bell's inequality is no longer met. The inequality is then suspended, and the path to local descriptions is open.

1.4. The 2-Photon Scenario – Local Reconstruction of the QM-Predictions

What does that mean: "Local reconstruction of the QM predictions for measurements on entangled photons"?

It means expressing – in a consistent way – the measurement values predicted by QM as functions of variables located directly at the position of the measurement – i.e. in one of the detectors –, and, additionally, adopting the structure of the whole scenario, which in turn means that the objects that are the carriers of these variables must originate from the decay at the position Z, then pass through the polarizers (or not) and ultimately arrive at the detectors (or not).

The first step is transferring the scheme of the ball-example to the 2-photon scenario. For that only one single condition has to be met:

The measuring result must not correspond to the attribute of an object. Instead only the accumulation of objects should trigger an event.

In the case of photons, the way to meet this condition is actually very simple and obvious. The dualistic model of radiation does indeed contain besides the concept "particle" also the concept "wave". Thus all that is needed is to assume that not the particle but the accumulation of waves triggers the event.²¹

²¹ Remember that, in this first round of EPR, the only objective is to refute the general conviction that equation (2) cannot be substantiated by a local model. The power of Bell's proof lies indeed in its claim to hold independently of any kind of physics. Thus at first it must be shown that this claim is actually not justified. For now, the physical implications can be ignored. Of course they will be discussed later.

Concretely, this assumption reads as follows: *The discontinuous transitions between different states where "photons" are generated or detected are the consequence of continuous emission or accumulation of light waves. As a result of this assumption, "photons" are **defined** as such transitions.*

In the case of entangled photons, these waves are emitted as pairs. Their polarization directions are at random. (Equally distributed between 0 and 2π .)

This assumption forbids – exactly in the same way as in the example of the previous section – to transfer any event of one experiment into another experiment; Statements about what would be the result if a specific pair of objects (that is: all the waves that have been emitted into both directions since the previous event-pair) which have already been measured, were measured again, are then no longer possible. This means: Bell's inequality cannot be derived; the proof of non-locality disappears. (Later I will go more extensively into this issue.)

With this, the scheme of the example has already been transferred to the photon scenario.

However now, in addition, a rule is needed which – in connection with the function for calculating the measurement values, which will be presented in the following – guarantees that equation (2) holds for all event pairs of a series, e.g. that for $\delta = 0^\circ$ (both polarizers are adjusted at the same angle) *never* simultaneous transitions on both sides occur, or that for $\delta = 90^\circ$ the transitions are *always* simultaneous.

The rule that meets this requirement is "borrowed" from quantum mechanics:

The angle between the polarization directions of the waves that are emitted as pairs into opposite directions is equal to the angle between the polarizations of the measured photons. (90° in our case.)

Regarding all other parameters, we assume the waves to be completely symmetrical.

It must be cleared up yet what it means, in this model, that *a photon with a certain polarization direction* is measured. It has the following meaning: waves that have passed through a polarizer adjusted at this angle cause a transition. To this transition – i.e. to the "photon" – can then be assigned the attribute *polarization at this direction*. Here, only in this sense we can speak of the attribute *polarization of a measured photon*.

Therefore, the whole scenario can be outlined in the following way: (S2 differs from S1 because of the assumption of the hidden parameter *polarization of the light waves*. Please note however that this

hidden parameter *is not identical* with the hidden parameter *polarization of the photons*, which is part of the EPR interpretation of the scenario!)

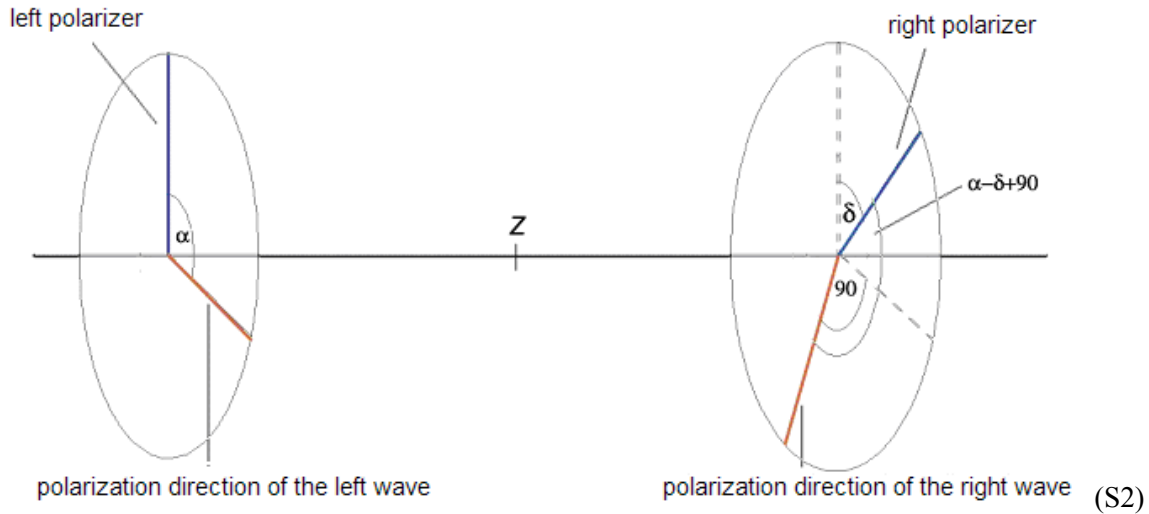

Let the left polarizer be adjusted at the angle 0° , the right one at the angle δ . Let α_i be the random polarization angles of the waves on the left side, accordingly $(\alpha_i + 90)$ those of the waves on the right side. As regards the amplitudes of the waves, no specific assumptions are needed. Therefore they can be set to 1. Then $\cos \alpha_i$ are the amplitudes of the waves which have passed through the left polarizer, $\cos(\alpha_i + 90 - \delta)$ the corresponding amplitudes to the right.

With this, all resources needed for the local reconstruction of the quantum mechanical results of experiments with polarization measurements on entangled photons are prepared.

At first we define random variables X and Y as follows:

$$X_i = \cos^2 \alpha_i \quad (1 \leq i \leq n) \quad (5)$$

$$Y_i = \cos^2(\alpha_i + 90 - \delta) \quad (1 \leq i \leq n) \quad (5')$$

Thus in this model the random variables are the squares of those wave amplitudes which *actually* arrive at the detectors. So they are without any doubt *local variables*.²²

Assertion:

Let $I = \{ i \mid 1 \leq i \leq n \}$ be the set of the numbers of random variables in the case of a total number of n pairs.

Let $I_L = \{ i_L \}$ be the subset of I , where $X_{i_L} > 1/2$, $I_R = \{ i_R \}$ the subset of I , where $Y_{i_R} > 1/2$, and $I_{LR} = \{ i_{LR} \}$ the subset of I , where $X_{i_{LR}} > 1/2$ and $Y_{i_{LR}} > 1/2$. ($I_{LR} = I_L \cap I_R$)

Let w_L be the probability of the appearance of a photon on the left side, w_R the according probability on the right side, w_{LR} the probability of the simultaneous appearance of photons on both sides.

Then applies (with $n \rightarrow \infty$)

$w_L = \frac{\pi}{n} \sum_{i \in I_L} (X_i - 1/2) = 1/2$	$w_R = \frac{\pi}{n} \sum_{i \in I_R} (Y_i - 1/2) = 1/2 \quad (6)$
$w_{LR} = \frac{\pi}{n} \sum_{i \in I_{LR}} (X_i - 1/2) = 1/2 \sin^2 \delta$	$\left[= \frac{\pi}{n} \sum_{i \in I_{LR}} (Y_i - 1/2) \right] \quad (7)$

Proof:

We look at the \cos^2 -curve. (δ is the angle between the two polarizer planes.

²² As can be seen, in the following formulas for calculating the probability of photon detections, only amplitude squares greater than $1/2$ are taken into account. Obviously, this is the easiest way to assure that there are no common events if $\delta = 0$, because in this case only on one side the amplitude square is greater than $1/2$.

Remarkably, this condition alone is also sufficient for any other δ . I think, already the simplicity of formula (7) is a strong indication that the specific kind of entanglement in this scenario – and therefore also the statistics of the resulting measurements – is somehow contained in the experimental setup. However I abstain from presenting the associated physical processes because, in my eyes, some additional assumptions make them unattractive.

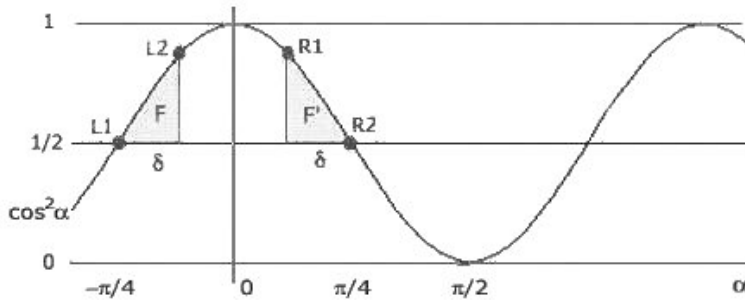

(S3)

If α (the angle between the oscillation direction of the wave and the polarizer plane on the left side) lies between L1 and L2, then $\alpha+90-\delta$ (the according angle on the right side) lies between R1 and R2. It can be seen that only for $-\pi/4 < \alpha < -\pi/4 + \delta$ and for $3\pi/4 < \alpha < 3\pi/4 + \delta$, the amplitude squares (i.e. the random variables) on both sides are greater than 1/2.

The area F is equal to the area F', and therefore

$$F = \int_{-\frac{\pi}{4}}^{-\frac{\pi}{4} + \delta} \cos^2 \alpha \, d\alpha - \delta \frac{1}{2} = \frac{1}{2} \sin^2 \delta \quad (8)$$

With $n \rightarrow \infty$, the sum in (7) corresponds exactly to this area F.

The sum in (6) corresponds to the area, which is enclosed by the \cos^2 -curve and the 1/2-straight between $-\pi/4$ and $\pi/4$; therefore the result of (6) corresponds exactly to that of (7), if in (7) δ is set to $\pi/2$; thus it amounts to 1/2.

With this we have reached our intended target. In (6) and (7), the sought probabilities are expressed as functions of subsets of the random variables on one side, that is: by local conditions. Also in the case that the attribute by which a subset is defined, refers not only to the random variables on one side but – as in (7) – also to the ones on the other side, there does not occur any problem, because for setting up equation (7), only the *existence* of this attribute must be presupposed.

Hitherto we have only discussed the case where the angle between the polarization directions of the pairwise emitted photons is equal to $\pi/2$. The generalization to any desired angle ζ is trivial, because evidently the relation between the values of the amplitudes which pass through the polarizers to the left and to the right, depends in any case on the difference angle ($\zeta - \delta$).

Thus I will just present the equation. It reads as follows:

$$W_{LR} = \frac{\pi}{n} \sum_{i \in I_{LR}} (X_i - 1/2) = 1/2 \cos^2(\zeta - \delta) \left[= \frac{\pi}{n} \sum_{i \in I_{LR}} (Y_i - 1/2) \right] \quad (9)$$

Equation (9) produces in all possible cases results which are identical with the quantum mechanical ones. (E.g. from $\zeta = 0$ (which means that the measured photons have the same polarization) follows $W_{LR} = 1/2 \cos^2\delta$.)

1.5. Additional Notes

1. In this local model, it is presupposed that the discrete transitions in the detectors are caused by continuous accumulation of waves. From this follows that in general it is not possible to assign the electromagnetic waves that are underway simultaneously to a single such accumulation process, the consequence of which will then be the detection of a photon. Instead it must be assumed that they contribute to many such processes. Thus, in general, a transition which represents a *detected photon* cannot be traced back to a transition which represents a *generated photon* (or photon pair, respectively). This is the reason why – as in the example with the balls – Bell's inequality does not apply. More to that will immediately follow in the next section.

2. The waves with different polarization directions that are emitted as pairs can also originate *from one single decay*. (This assumption does not contradict quantum mechanics, where these waves don't even exist.)

3. Equations (6), (7) and (9) apply also in the case of a series of *single processes* (event pairs), which are experimentally separated from each other. However also in this case, there are at any time other simultaneously proceeding accumulation processes that have *not yet* led to transitions.

4. The model presented here is local in every detail: Pairs of waves are emitted during a transition between two different states of an object. They are polarized at a certain angle to one another and symmetrical in every other respect. Their amplitudes are reduced by polarizers with a given direction. The squares of these amplitudes represent the random variables X and Y. The event probabilities are expressed as functions of those random variables the carriers of which actually arrive at one of the two detectors.

In general the following applies: One can only be sure that there is no non-local connection between two measurements at different positions, if the entire causal chains are known that eventually lead to the values of those variables located directly at the positions of the measurements, by which the measurement values – which are defined as functions of them – are calculated. This presupposes in turn that both causal chains start at the same point. (Otherwise they would lead ever further into the past.)

Exactly these conditions are met here.

1.6. Why is Bell's Inequality not applicable here?

In the local model, it is assumed that in the detectors continuous accumulation processes are running simultaneously which later will lead to transitions (detected "photons").

Where and when transitions occur that correspond to detected photons depends on the waves which arrive at the detectors *and* on the specific conditions in the detectors. However in any case part of these conditions are the waves that come from antecedent decays and have *not yet* led to transitions.

It is obvious that, under these presuppositions, there cannot be any event pairs which are independent from the course of the experiment. However because of the importance of this fact I will go a bit more into detail.

If one would e.g. try to express the event pair with the number k as function of the waves which have arrived at the detectors since the event pair with the number k-1,²³ then this purpose must fail, because the kth event pair does not only depend on *those* waves but also on the waves that have arrived at the detectors already before.

²³ This would correspond to a *move* in the example with the balls given in 1.3.

Another possibility would be to assign to a photon event the set of random variables which contains exactly those variables that have *in fact* contributed to this specific transition.

So let A_k be the k^{th} event to the left, $A_k = 1$ (a photon is detected). Let $\{X\}_k$ be the set of random variables which caused this event. $\{X\}_k$ contains then not only waves from the k^{th} decay but also waves from the decay with the numbers 1 to $k-1$.

The chronological order of the emitted waves with different polarization directions changes with every experiment. Therefore, it depends on the specific course of the experiment, which random variables are contained in $\{X\}_k$. This means: Even if all those random variables would occur in any other experiment with identical polarizer directions, with $n \rightarrow \infty$ (n number of the random variables) the probability would come to zero that the set $\{X\}_k$ will again lead to exactly *one* transition. With certainty, in any other experiment the random variables of $\{X\}_k$ will not cause one single transition but contribute to many different transitions.

Thus also with this definition the events cannot be separated from the specific course of the experiment.

In fact there is no definition at all by which such a separation could be substantiated. Rather the following applies:

In the local model, there are no event pairs $(A | B)$ which are independent of the course of the experiment and could therefore also occur in any other experiment. Instead there are pairs of events $(A_k(E_m) | B_k(E_m))$ which are *inseparably* bound to the course of the specific experiment E_m , which means that they occur only in *this* experiment exactly at *this* point in time.

Therefore it is not possible to predict anything about the results of other measurements on the same objects.

In the interpretation of the scenario with entangled photons which serves as basis for the derivation of Bell's inequality, there is no such limitation. Here, every event pair is independent of all previous event pairs and, therefore, also independent from the course of the experiment. Thus the events are not bound to a specific experiment. Assumptions about other measurements on the same objects are permitted.

Exactly this difference between Bell's interpretation and the one presented here is the reason why it is not possible, to deduce any inequality of Bell's kind in the local model, because in order to deduce

such an inequality, information about the results of the *one* experiment that was actually performed does not suffice – in any case information about other measurements *on the same objects* is involved.

To conclude the issue, this shall now be demonstrated using Bell's paper²⁴ from 1964 as an example.

In the following, λ stands for any variables, which the measurement results A and B can depend on in any possible way. ($A = \pm 1$, $B = \pm 1$; +1 means: photon, -1: no photon.)

\vec{a} , \vec{b} and \vec{c} are unit vectors in the directions of the polarizer planes. ρ is the normalized probability distribution of λ . $P(\vec{a}, \vec{b})$ is the expected value of the product of A and B.

Just before the end of the derivation, we find the equation

$$\begin{aligned} P(\vec{a}, \vec{b}) - P(\vec{a}, \vec{c}) &= - \int d\lambda \rho(\lambda) \left[A(\vec{a}, \lambda) A(\vec{b}, \lambda) - A(\vec{a}, \lambda) A(\vec{c}, \lambda) \right] = \\ &= \int d\lambda \rho(\lambda) A(\vec{a}, \lambda) A(\vec{b}, \lambda) \left[A(\vec{b}, \lambda) A(\vec{c}, \lambda) - 1 \right] \end{aligned}$$

Here it is presupposed that $A(\vec{b}, \lambda) A(\vec{b}, \lambda) = 1$, which, in the usual view (and notation!), appears as a matter of course.

But in the local model, the two expressions $A(\vec{b}, \lambda)$ are *not* identical. As the following steps of the derivation show

$$\begin{aligned} \Rightarrow \quad & \left| P(\vec{a}, \vec{b}) - P(\vec{a}, \vec{c}) \right| \leq \int d\lambda \rho(\lambda) \left[1 - A(\vec{b}, \lambda) A(\vec{c}, \lambda) \right] \\ \Rightarrow \quad & 1 + P(\vec{b}, \vec{c}) \geq \left| P(\vec{a}, \vec{b}) - P(\vec{a}, \vec{c}) \right| \end{aligned}$$

they must be assigned to events of two different experiments: the first one to an event of an experiment with the polarizer directions (\vec{a}, \vec{b}) and the second one to an event of another experiment

²⁴ John Stewart Bell, *On the Einstein Podolsky Rosen Paradox*, Physics, 1, 195-200 (1964). (Bell's proof relates to spin ½ particles. However it applies also to photons.)

with (\bar{b}, \bar{c}) . However in the local model, as demonstrated just before, no conclusion is possible from the event of the first experiment to the event of the second experiment. The assumption $A_k(E1) * A_j(E2) = 1$ is not permitted for any (k, j) .

Thus the derivation of the inequality fails, and the same applies, as mentioned above, for any inequality of this kind.

1.7. Summary, Closing

To anyone who is not familiar with the EPR scenario, the deliberations of the last two sections may have seemed rather complicated. Fortunately, the actual reason why a local interpretation has been ruled out by the hitherto prevailing view of the EPR paradox and why it is possible in the new interpretation is actually very simple.

So let us finally compare the common view of the course of an experiment with entangled objects with the view which the alternative local model is based on:

In the common view, there are pairs of entangled objects which cause pairs of events. After every event pair, the respective physical process is completely finalized, and with the next decay a new process starts that is totally independent of all the previous ones. Every experimental series is a sequence of such processes that are independent from each other.

If one adds to that – as EPR did – the condition **A1** from Section 1.3 (the independence of the measurements on both sides), then also the condition **A2** (statements about further measurements on the same objects are possible) is met, and Bell's Inequality can be derived. *Locality is ruled out.*

In the alternative local model, this is completely different. Indeed, also here both sides are independent from one another, and the measurement result is determined already before the measurement – however it depends not only on the current object-pair but also on the whole preceding course of the experiment.

Thus the series of measurements in an experiment is no longer a sequence of separate processes that are finished with the according measurement result – rather the whole experiment must be seen as *one total process* where any previous measuring procedure affects any later one. (In the same way as in the illustrative example with the balls.)

No event pair can be separated from such a specific total process.²⁵

Then, however, the condition **A2** is not met: predictions about further measurements on the same objects are not permitted, and Bell's Inequality cannot be derived. *Locality is possible.*

Of course, also in the local model the entanglement condition must be satisfied – this is the objective of the function through which the quantum mechanical predictions are reproduced – but it applies only to pairs of events that occur during a certain measurement series. Statements about further measurements on any object pair of this series are not possible.

In short, the decisive point is the following one:

In the local model, the event pairs depend on the course of the experiment. But for the derivation of Bell's inequality, they would have to be independent of all other event pairs. Therefore, in the local model the inequality cannot be deduced.

Then, however, the proof of non-locality disappears, and the path to local descriptions is open. And using this openness leads in fact to success, as just demonstrated with the example of entangled photons.²⁶

With this, the assertion is falsified that the measurement results on entangled photons cannot be generated by any theory with only local parameters. However the function presented in (9) does not make much physical sense, which however is without any relevance as regards the falsification. I chose it only because of its simplicity.

An understandable and physically meaningful solution – which however originates from the same scheme – will be presented after the interpretation of special relativity and the alternative description of both the Photoelectric and the Compton Effect, subsequent to the interpretation of quantum theory.

²⁵ In the case of the measurement of a single event pair, the preparation of the experiment provides for the correctness of the predictions. (In other words: it makes sure that a series of such measurements leads to the predicted distribution of the measured values.)

²⁶ In the introduction, I said that the everyday language, augmented by some mathematics, is more appropriate for the solution of some problems than the physical terminology. The local solution of the EPR paradox is an example for that: If the 2-photon system is seen as a vector in the product space of the 2-dimensional Hilbert spaces of the two particles, then the just performed deliberations are impossible. The reality that lies behind the formalism and substantiates it has vanished.

All these descriptions will turn out to be elements that unite to a mosaic, to a graphically intelligible model which permits to reinstitute also other principles of reason – in the same way as it has just happened with the principle *locality*.

Note:

The problem of "impossibility proofs" is that they must apply *in all possible worlds*. The "set of possible worlds", however, is unknown.

Therefore it can happen – as has been demonstrated in the just performed refutation of Bell's proof of the impossibility of local descriptions of entangled systems – that a world is overlooked, which is out of sight not because of its strangeness or improbability, but simply because it is unreachable on the well-trodden interpretation paths.

I remind you once again of the ball example from 1.3, which illustrates the new view: Here, no strange or exotic reality is presented, but a completely understandable, local and objective reality – and of exactly this kind is the reality that underlies the quantum mechanical description of entangled systems.

Double Miracles

Some time ago, a friend of mine and I laughed heartily about a newspaper article, which reported on a double miracle:

During a séance, a heavy statue rose from the floor and flew across the room on a complicated path with great speed. But not only that – though the room was full of objects, the statue managed somehow, with incredible dexterity, to avoid any collision and fly around all these obstacles, before it finally ensconced itself again at its original spot, so that after this magic episode everything looked exactly like before – just as if nothing had happened!

At least as much, however, we laughed about another double miracle, which physicists like to tell each other and the bewildered public.

There are, so they say, mysterious connections between objects far away from each other: if Alice manipulates *her* object in a certain way, then her friend Bob's object jumps suddenly into a different state.

Awesome! – thinks the bewildered public, dreams about intergalactic sex and plans to purchase a set of voodoo puppets.

Hold on! say the physicists and tell about another miracle – a really insidious conspiracy: nature does not only arrange such magical voodoo-connections in our universe, it arranges them with incredible dexterity exactly in such a way that they can definitely not be used for transmitting any information – just as if they were not there at all!



2. New Interpretation and Explanation of Special Relativity

2.1. Introduction

In the physics of the second half of the 19th century there was a gap between mechanics and electromagnetism:

In the field of *mechanics*, all uniformly moving systems were considered as being physically indistinguishable, that is to say: identical experiments and measurements within different uniformly moving systems were supposed to lead to identical results. Here movement was thus *relative*. The conversion from one system to another (Galilean Transformation) conformed completely to the *a priori* concept of space and time. (The difference of the velocities of an object with respect to two different systems, in particular, corresponded exactly to the difference of the velocities of these systems themselves.)

As the electromagnetic equations are *not* covariant with respect to Galilean Transformations, it had to be postulated that in the field of *electromagnetism* a preferred system exists (the ether, carrier of the electromagnetic waves), in which the description of nature assumes its simplest form. That system was thought to be at rest. With electromagnetic phenomena, identical experiments and measurements in different uniformly moving systems ought to lead to different results. For this reason movement was here *absolute*.

Accordingly it should have been possible to determine the movement of the earth with respect to the ether by means of measurements on suitable electromagnetic phenomena. In contrast to this expectation, however, all attempts to measure such a movement with the aid of the velocity differences of light waves traveling in different directions came to naught: never was any difference found to occur.

The special theory of relativity eliminated the gap between mechanics and electro-magnetism and, at the same time, resolved the contradiction with the experiment by establishing two postulates:

1. The impossibility of distinguishing between uniformly moving systems with respect to *all* physical phenomena (– this is the principle of special relativity);
2. The constancy of the speed of light for all uniformly moving observers.

The second of these postulates determines which transformation must be chosen: that with respect to which the electromagnetic equations are covariant (the Lorentz Transformation).

The *a priori* Galilean Transformation is thus valid only by approximation, i.e. the mechanics connected with it must be corrected.

2.2. Why does Nature conform to the Spacetime Conditions determined by Light?

During the first years after the theory of special relativity was born, all involved parties – and indeed all parties not at all involved too – were so occupied with expressing their fascination or aversion that they didn't think at all about the *actually* important question:

Why does nature conform to the spacetime measures determined by light signals?

Later, when the correctness of the theory could no longer be doubted, dealing with the relativistic formalism had become so ordinary that this question didn't cross anyone's mind. Why ask for the reason of something so reliable and self-evident?

However, actually only the consequent investigation of this question permits a true understanding of relativistic phenomena. Yet not only for this reason it is important to ask for the ontological cause of relativity, even more relevant is that the answer entails a rearrangement of the conceptual foundations of the description of nature and leads to a radical change in our understanding of reality. To say it with the words of John Archibald Wheeler:²⁷

Some day a door will surely open and expose the glittering central mechanism of the world in its beauty and simplicity.

It is remarkable that for this purpose neither physical nor mathematical knowledge is required. I am tempted to say: on the contrary! Here it can in fact be an advantage to possess no such knowledge. Because of their everyday handling of mathematical formulas, physicists tend to identify reality and description – or, to put it correctly: to confuse the one with the other. Then, however, the question formulated in the title of this section disappears: if nature *is* the formalism, then it is senseless to ask

²⁷ In: *Gravitation*, Freeman, San Francisco 1973, p.1197. (Wheeler himself did not believe that such a mechanism could be found.)

why it *conforms* to it. To be able to ask this question at all, a concept of nature is needed which substantiates the formalism and can be confronted with it.²⁸

Nature is *never* identical with its formal description. Reality *is not* a four-dimensional Minkowski space with the coordinates x_1, x_2, x_3 and ict – just as a fish-population *is not* the logistic equation.

Reality is *motion of objects in three-dimensional space*, and therefore the question arises *why* it is appropriate to describe this reality by the Minkowski space, in other words: why all uniformly moving observers measure the same value for the speed of light.

Without the conception of moving objects in space, the principle of relativity would not exist at all; as is well known, this principle originates from the insight that motion cannot be defined against (empty) space. Motion of an object can only exist relative to another object. Space itself is not such an object.

2.3. Einstein's Scenario

At the contemporary level of physical knowledge, the necessity of SR can be realized, but the relativistic phenomena *as such* must simply be accepted. Certainly, a model would be preferable that permits *understanding* these phenomena by providing insight into the underlying coherences.

Such a model will be presented in the following. However it lies far beyond the usual physical reasoning. In order to arrive there, as already mentioned, no formal tools are required. It is a purely interpretational question, or say: a question of geometrical and logical reasoning.

To begin with let us enter the well-known scenario which Einstein invented for illustrating the relativity of simultaneity.

²⁸ The first step to this confusion is the wide-spread conviction that "mathematics is the language of nature". This may be true – however if one believes that *everything* can be said with mathematics, then one will fall short and, in the end go astray.

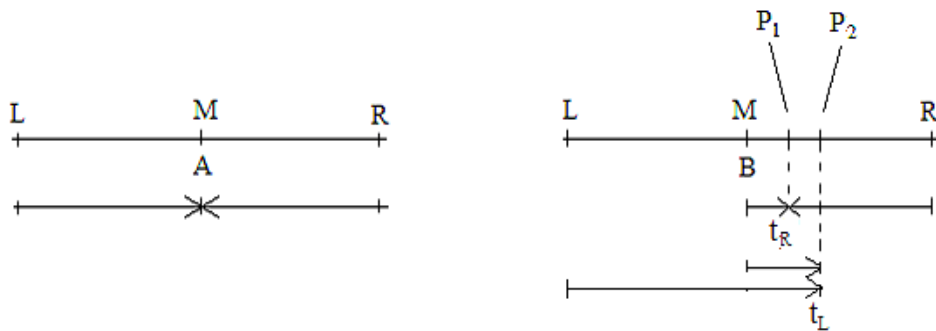

(S1)

In this outline, M is the medium point of the line segment between L and R.

A and B are two observers, who are both at the time $t_0 = 0$ in M. A rests and remains in M, B leaves M and travels uniformly towards R.

Light signals emitted from L and R at the time t_0 (with respect to A) which arrive at A simultaneously do *not* arrive simultaneously at B: the signal from R will arrive *earlier* at B (at point P_1 at the time t_R) than the signal from L (which arrives at point P_2 at the time t_L).

Let the time difference between the arrival of the left and the right signal be Δt :

$$t_L - t_R = \Delta t$$

So much to the relativity of simultaneity. This time however we will extend the discussion of the scenario a bit further.

Say, for A the moment t_0 in L and R is *now*, that is: A's *present*. The suspension of simultaneity with respect to B means that the time of the emission of the light signal from R must be shifted into B's *past*: B is moving towards the signal, therefore it must arrive at him earlier than it arrives at A, which means that, in comparison with A, it must have been emitted earlier. Thus, for B, the emission of the signal from R must be a *past* event. In the same way holds that for B the emission of the signal from L is a *future* event.

However this shift of the one event into the past and of the other one into the future of B – always in comparison with A – is only then possible and necessary if the following is true:

Each pair of identical signals, which belong to the system of the moving observer B and originate at L and R at the same time t_0 as the light signals (or, to put it more generally: each pair of identical processes which start at L and R simultaneously at t_0) and move towards B in a straight line, arrive at B with the same time difference Δt as the light signals.

Only under this premise, the suspension of simultaneity – and with it also the determination of the altered times that apply to L and R with respect to B – is a possible and necessary act. If there were any pair of signals or processes which would not meet this condition, then the determination of the space and time measures by light signals would be wrong.

Now, if one does not proceed immediately, as usual, to the relativistic formalism, but instead keeps looking at this circumstance as it is seen in that kind of reality, which Einstein's scenario is about – objects moving in three-dimensional space – then it becomes evident how immensely strong the condition is which, in this way, is imposed on this reality.

Let us demonstrate this by an example. Let A and B be observers in spaceships. Let the spaceship of A be at rest, the spaceship of B move relative to A with velocity v .

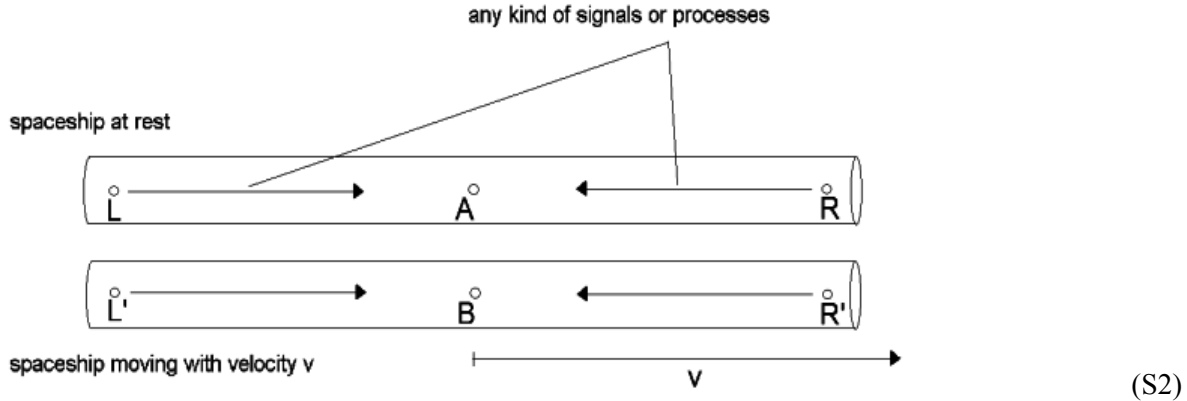

$LA = AR = L'B = BR'$ (with respect to A at the instant depicted in the outline)

From R and R', L and L', light signals are emitted, simultaneously with respect to A. They arrive of course simultaneously at A and again with the time difference Δt at B.

However now, simultaneously with the light signals and at the same positions, also other signals are generated, say: sound signals in the metal bodies of the spaceships or in the air contained within them. (However one could also fire bullets or produce any other shenanigans.)

At first, the light signals will arrive at B, and then, with different delays, the other signals. However for *all* pairs of identical signals holds: the time difference between their arrivals at B is always the same, and it is equal to the time difference of the light signals.

As regards the light signals, this time difference is a matter of course. One can "see" that B moves towards the one signal so that it will arrive at him earlier than the other one. But as regards the sound signals, this is evidently not true: these signals are *carried along* by the spaceship of B, and no reason is in sight, why any time difference at all should occur.

In order to demonstrate how strange that is, even after a hundred years of SR, we shall take a closer look at this issue:

With respect to A, the sound signals are emitted simultaneously. Some resting observer A', who is positioned before A (with respect to the direction of motion of B), can later inform A that these sound signals arrived at B with a certain time difference. As seen from A, this can only mean that the signal which came from the front must have been *faster* than the one from behind. Yet again: both signals are *traveling within the spaceship* of B, and whereas it is self-evident to A that the simultaneously emitted light signals must arrive at the moving observer B with a certain time difference, it seems absolutely inconceivable to him why also the sound signals, which are propagating within the metal body of B's space ship, should arrive at B with the same time difference. There is just no plausible reason for that.

Of course the problem disappears immediately if we take into account what we already know – i.e. that for B the events in L' and R' are *not* simultaneous, and that, therefore, with respect to B the velocities of the signals are identical. However with this "solution" we would use as explanation exactly that what we want to explain!

Above all, the whole issue seems altogether paradoxical for the following reason:

On the one hand, it is true that motion cannot be defined relative to space.

On the other hand the following can be stated: A *sees* that the sound signals are generated simultaneously. He *knows* that the distances between the positions of their generation and the position of the observer B are identical, and he *learns* that the signal from the front reached the observer B earlier than the one from behind. So he *must conclude* that the movement against space – *which cannot exist at all* – has influenced the velocity of the sound signals: the one from the front was accelerated, the one from behind decelerated.

Once again: of course one can apply the SR formalism and in this way eliminate the problem. But actually it does not disappear at all. With this formal act, one has just disposed of nature by a set of rules. And indeed nature obeys! – However it has not in the least become clear why. The connection between reality (moving objects in three-dimensional space) and formalism (Lorentz transformation) remains unexplained.

The space in which the problem dissolves is the four-dimensional Minkowski space. But the space, in which the just mentioned experiences and conclusions of the observer A are located, is the normal three-dimensional space with objects moving therein – i.e. exactly the space which Einstein's considerations about the relativity of motion relate to. And in exactly this space, which should be indifferent against motion, now – for A – an alteration of the sound speed occurs, and it has to be cleared up, what the reason for this alteration is.

The general question posed at the beginning of this section: "Why does nature conform to the spatial and temporal measures determined by light?" has now been concretized to the question of our example:

Why does the sound signal from the front arrive earlier at the moving observer than the one from behind – and, moreover, why is the interval between the two signals equal to the interval between the light signals?

As preparation, we proceed to another scenario. Though it is completely trivial, it is still useful for the following considerations, because here questions and answers are possible without any limitations by entrenched thinking habits that would otherwise be inevitable.

2.4. The second Scenario

We are standing on a widely extended plane. Above the plain there is air, of normal pressure and unmoved. We look from above at a flying carpet, which however for the moment is lying flat on the plane.

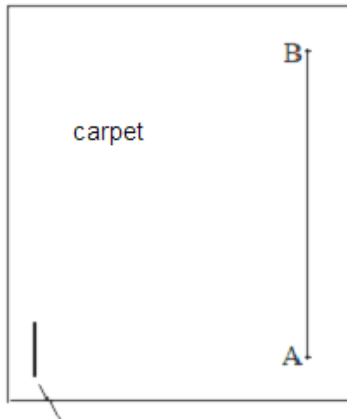

sound reflector R

(S3)

On the carpet there are two observers A and B and a sound reflector R.

Both A and B carry a sound reflector too. In addition, each of them has two clocks of the following kind: an empty dial with a single hand that rotates uniformly. Both observers carry a pen for marking the dials.

Now the following procedure is performed:

1. A sends repeatedly sound signals towards B and simultaneously towards the reflector R. B reflects the signals back to A. A beckons B to come closer until he receives both reflected signals at the same time. From this moment on B remains at his position.
2. A takes one of his clocks; then he sends a sound signal towards B and writes simultaneously **0** onto the position of the dial where the hand points at that very moment.
3. B receives the signal, reflects it back to A and writes simultaneously **1** onto his dial.
4. A receives the signal, reflects it back to B and writes simultaneously **2** onto his dial.
5. B receives the signal and writes **3** onto his dial.

With this, we have defined a full measurement system of lengths and times. A and B can complete their scales. (A has the points 0 and 2, B has 1 and 3.) We call the time unit *second*, the length unit *sound second* – which in this case is the distance AB (or AR, respectively). The sound velocity is 1.

Now the carpet rises, accelerates and eventually moves uniformly at a speed near the speed of sound parallel to the distance AB (B is ahead of A).

A and B take their other clocks and perform the same procedure as before. Afterwards we have again a complete measurement system. Again we call the time unit *second* and the length unit AB (or AR, respectively) *sound second*.

During the course of the flight the following phenomena can be observed (A and B are able to read some of them directly by comparing the clocks marked at rest with those marked at the flight).

a) At 1.: B has to move closer to A.

b) At 2. and 3.: It takes a long time until the signal arrives at B, because B is moving away from the sound signal at a speed near the speed of sound. (In spite of that A writes **0** and B writes **1** onto his dial.)

c) At 3. and 4.: In contrast, the way back is very short: A moves towards the sound signal.

d) From a) follows that in the direction of motion the length unit is contracted.

e) From b) and c) follows that the *second* which applies during the flight is expanded compared to the *second*, which applied at rest. (If the carpet moved at sound speed, the flight *second* would last forever.)

f) From b) and c) follows also that simultaneity has changed, that is: if the clocks marked at rest indicate identical times, the other clocks do *not*. (An observer at rest could say: the second towards the front lasts much longer than the second towards the rear.)

g) Again the sound velocity is 1: if a sound signal coming from ahead or from behind passes the first observer at the moment when the dial points at n , then it will pass the other observer at $n+1$; the clocks are set that way. (However the sound velocity is 1 at all other directions too.)

It is clear what we have done: We have built a measurement system on the flying carpet, which – compared with the measurement system on the resting carpet – is Lorentz-transformed. All relativistic phenomena can easily be observed.

And now we are going to pose an absurd question:

On the flying carpet, the *second* lasts much longer than on the resting carpet. Therefore the time of the flying observers progresses slower than the time of the resting ones. Does this mean that the flying observers will age more slowly than the inhabitants of the plane?

Of course not! – and why can we be so sure?

Because what we have done is purely arbitrary. To regulate space and time by sound signals (thereby making the sound velocity identical for all uniformly moving observers) means setting a standard to which nature will pay no attention at all.

The reason for this conviction is:

A time system, which is based on sound signals, can only apply to sound speed and to phenomena derived from it, and to nothing else.

What is meant by "*phenomena derived from sound-speed*"?

E.g. the velocities, with which superpositions of sound waves propagate. They could be described by the measurement system established on the plane and on the flying carpet, which means: in a *relativistic* manner, just in the way in which usually the analogous light phenomena are described. To sound waves the relativistic Doppler Effect would apply. Clocks, which could function on the basis of sound would show the "right" – which means: the "carpet"-time, but only if they were open so that the air would not be contained within them, and if their extent parallel to the direction of motion were corrected according to the sound-relativistic length-contraction.

Here the answer is clear and simple; it relates to the essence of the matter: Sound itself and everything which can be derived from it conforms to the measurement system based on sound signals. With respect to any other circumstances this measurement system does not hold true.

Now we are prepared to answer the question we asked at the beginning.

2.5. *The Answer*

In the previous section, we realized: if length and time measures are determined by any arbitrarily chosen wave-signals, then this measurement system applies only to the waves themselves and to phenomena derived from them. Nothing else obeys this measurement system.

Only with light, this does not seem to be true. The measurement system which is based on light signals applies to *all* phenomena.

The explanation of this fact is blocked by an apparently insurmountable problem: there seems to be no reason why the velocities of *all physical processes* – which occur indeed in three-dimensional space and not in Minkowski space – should change with respect to other reference systems exactly in such a way, that they conform to the scheme determined by light. The fact itself appears ontologically impossible, and the causal connection between reality and formalism remains a secret.

However only as long as we suppose that the phenomena are independent from light in just the same way as they are independent from sound! As follows:

To the carpet-system the following applies: The biological processes (the aging of the observers) are no sound-speed phenomena. Therefore they do not conform to the measurement system determined by sound.

Accordingly, for the measurement system determined by light, the following *should* hold true: The sound propagation in the metal, or the aging of the observers, are no light-speed phenomena. Therefore they cannot conform to the measurement system determined by light. But still they do! And no reason can be seen why.

This contradiction is eliminated by the following assumption:

There is in fact no difference between light and sound regarding the area of validity of the measurement systems based on them: both systems apply only to the phenomena that can be derived from the respective kind of waves.

This means that there is only one possible reason for the fact that in the case of light – contrary to sound – from this assumption does not follow any restriction (as indeed everything which exists conforms to the light-system):

Nature conforms to the measurement system of space and time determined by light because there is only light speed and phenomena derived from it.

What about other velocities? The assumption *there is nothing but light speed* leaves only one possibility for other velocities, that is: *interference*.

Everything which exists and which occurs is an interference phenomenon, a pattern of superpositions of waves with light speed.

To restrict myself – after this proposition which, if it was true (what I cannot doubt), would be one of the most important statements ever thought – to the narrow scheme of scientific descriptions which, though it is unavoidable, is so lifeless and emotionally flat, as if nothing has happened, would seem completely inadequate to me. Thus I ask:

Isn't this a fantastic hypothesis with a downright magical explaining power?

It is not only necessary and sufficient for the explanation of relativity, but permits also, as promised, a first glance onto *the glittering central mechanism of the world in its beauty and simplicity*.

However at first it is only a glance from great distance, and in order to see the mechanism more clearly – and also to just vindicate what can be seen here from afar, comparable to the moons of Jupiter in Galileo's simple telescope, against the physical inquisition – many further steps must be taken.²⁹

However some may consider my answer not magic but crazy. I think this is due to the fact that, in our insights about nature, we are subject to a double prejudice: about *being* itself and about its physical

²⁹ The relationship between my hypothesis and the system of contemporary convictions is of the same kind as the relationship between Aristarchos' hypothesis (that the earth is rotating and moving around the sun) and the worldview of that time. *Actually*, everything becomes very simple. But ostensibly verified knowledge is blocking the way to this simplicity.

However is it in fact justified to compare scientifically motivated objections against my hypothesis with the arguments that were brought up against Aristarchos? Is it possible to compare e.g. the argument that – if the earth rotated – storms would occur, with the argument that *particles* are an indispensable element of the scientific description of the world? Yes, of course it is justified. And, at that, I consider myself in a substantially better position as Aristarchos: He could not refute the storm-argument, because at that time the concept of uniform motion did not exist. But I can show that, at least in some cases of fundamental relevance, the particle concept can be dispensed with, and, additionally, that the abandonment of this concept is a necessary condition for the elimination of interpretative lack of clarity and of the occurrence of paradoxes.

description. In our experience, *being* is given *substantially*, and physics has originated from this premise and has never transcended this background – at least not in the field of interpretation.

Just before, it seemed to be natural and self-evident that a time based on sound applies only to sound phenomena and to nothing else. We posed the question: "Will the flying observers age more slowly than the resting observers?" and called this question quite rightly *absurd*.

But wouldn't the question if, in the case of a measurement system determined by light, moving observers were aging more slowly than resting observers, be equally absurd – *unless* aging would *ultimately* be a light speed phenomenon, an alteration of patterns shaped by waves?

Why is it not possible to draw the same conclusions with respect to the light-time as with respect to the sound-time? Because then it would be necessary to conclude that there is only light speed and phenomena derived from it, and it seems evident to us that the objects of our experience cannot be of that kind.

It is the aim of the next paragraph to challenge this conviction.

2.6. The short Path to Matter

In a universe where nothing but light-speed exists, objects must be wave superpositions.

In the theory of special relativity, at the transition from one frame of reference to another frame of reference – if appropriate coordinates are chosen – only the measures of two dimensions change: of the time dimension and of the space dimension parallel to the direction of the relative motion of the two systems.

Therefore, for the following analysis of relativistic circumstances, a simple model will suffice, where all objects are moving only along the x-axis.³⁰

It may appear that the hypothesis: "There is nothing but light speed" has brought us into an almost absurd distance from "normal" physics. Therefore, our first aim is to show that this assessment is not true and that, on the contrary, there is actually a very short path back to the usual physical model conceptions.

³⁰ In the following, this model will serve for reconstructing the relativistic spacetime structure.

Let S1 be a reference system at rest, S2 a reference system moving with velocity v relative to S1.

An object which rests in the moving system S2 can be represented by a wave superposition in the form of a *standing wave*:

$$y = \sin(2\pi f t) \cos(2\pi x \frac{1}{\lambda}) \quad (f \lambda = c)$$

Transformation to the resting system S1 leads to the wave superposition

$$y = \sin 2\pi \left(t f \frac{1}{k} - x f \frac{v}{c^2} \frac{1}{k} \right) \cos 2\pi \left(t v \frac{1}{\lambda k} - x \frac{1}{\lambda k} \right) \quad \left(k = \sqrt{1 - \frac{v^2}{c^2}} \right)$$

The *first wave* is a *de Broglie matter wave*.

Its frequency is $f \frac{1}{k}$, its wave-length $\frac{1}{f} \frac{c^2}{v} k = \lambda \frac{c}{v} k$ (λ Compton wave-length)

and its phase speed $u = \frac{c^2}{v}$.

The *second wave* has the velocity v – this is the velocity of the particle associated with the matter wave.

Therefore the following holds:

A standing wave in a moving system, which is generated by two waves with light speed, is – seen from the system at rest – the superposition of a matter wave and a wave with the velocity of the wave packet, i.e. of the associated particle.

In other words: Just the substantial being, the materially existing objects – which means: exactly that what seemed to be in blatant contradiction with the hypothesis: "There is nothing but light speed" – can be reconstructed by this very hypothesis by a very short thought train; – at least in the simple form of de Broglie's description, which however is of course the most we can get from our one-dimensional model.

2.7. Theory of Relativity without Relativity

The aim of this section is to determine explicitly the spatial and temporal relationships of the phenomena in the following way:

1. without postulating relativity or the constancy of the speed of light for all uniformly moving observers,
2. in a way which makes these relationships directly understandable,
3. based on the premise that everything which exists and which occurs – every object and every process – is ultimately a superposition of waves with light speed.

Objects at rest will be represented by standing waves, accordingly moving objects by countermoving waves with different frequencies. Frequencies and wave lengths of waves traveling in opposite directions will be indexed with arrows (\rightarrow or \leftarrow). All waves travel at light speed.

Let S be the system at rest. Let Ψ' be a superposition of two waves traveling in opposite directions with frequencies ν_{\rightarrow}' and ν_{\leftarrow}' . Our first objective is to determine the velocity v of the system S' where Ψ' is a standing wave with frequency ν_T .³¹

The circumstances correspond to those in the normal (non-relativistic) Doppler Effect, where an observer who travels with velocity v measures the same frequencies on waves from the front and from behind.

³¹ However, the idea of wave superpositions is applicable not only to standing waves. E.g. it can also be transferred to a case where the direction of the wave propagation is curved so strong that a rotating wave structure develops:

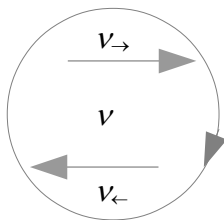

ν is the frequency of the rotating wave structure. If this structure is at rest relative to the observer, then $\nu_{\rightarrow} = \nu_{\leftarrow} = \nu$. If it moves in the plane normal to the axis of rotation, then ν_{\rightarrow} becomes ν_{\rightarrow}' , ν_{\leftarrow} becomes ν_{\leftarrow}' , ν becomes ν_T , and the subsequent derivations apply.

(Obviously, this model is not meant to be realistic; what is required is only the existence of the two countermoving waves.)

Thus it applies that $v_{\rightarrow}' (1 - v/c) = v_{\leftarrow}' (1 + v/c) = v_T$ (1)

from which follows: $v_{\leftarrow}' / v_{\rightarrow}' = (c - v) / (c + v)$ (2)

and $v / c = (v_{\rightarrow}' - v_{\leftarrow}') / (v_{\rightarrow}' + v_{\leftarrow}')$ (3)

as well as $v / c = (\lambda_{\leftarrow}' - \lambda_{\rightarrow}') / (\lambda_{\leftarrow}' + \lambda_{\rightarrow}')$ (4)

From (3) follows that the velocity v of the object represented by the superposition depends on the frequencies of the two countermoving waves. Thus an alteration of the velocity is equivalent to an alteration of the frequencies.

According to our premises, Ψ' is a standing wave with frequency v_T in S' . Let us now assume that Ψ' has emerged from a wave Ψ with frequency v , which was a standing wave with respect to S , by an *acceleration* along a line segment AB . (In the usual view: an object at rest has been accelerated up to the velocity v .) Which alteration of the frequencies of the countermoving waves corresponds to this acceleration?

In the case of *any* acceleration, we assume for the frequencies of the waves traveling to the right

$$\forall v_{\rightarrow}: v_{\rightarrow} \mapsto v_{\rightarrow}' = f(v_{\rightarrow}) \quad (5)$$

and – as any wave which has traveled along AB , should, after the reverse travel BA , again have the original frequency – for the frequencies of the waves traveling to the left

$$\forall v_{\leftarrow}: v_{\leftarrow} \mapsto v_{\leftarrow}' = f^{-1}(v_{\leftarrow}) \quad (6)$$

We postulate the acceleration as independent of frequency. By inserting (5) and (6) in (3)

$$v / c = (f(v) - f^{-1}(v)) / (f(v) + f^{-1}(v)) \quad (\text{note } v_{\rightarrow} = v_{\leftarrow} = v) \quad (7)$$

it is easy to see, that this postulate is met in the simplest way by setting

$$v_{\rightarrow}' = f(v_{\rightarrow}) = q v_{\rightarrow} \quad \text{and} \quad v_{\leftarrow}' = f^{-1}(v_{\leftarrow}) = q^{-1} v_{\leftarrow} \quad (q \in \mathbb{R}, q > 0) \quad (8)$$

Then the equation of the velocity of the standing wave reads as follows:

$$v/c = (q v - q^{-1} v) / (q v + q^{-1} v)$$

or – after canceling the frequency

$$v/c = (q - q^{-1}) / (q + q^{-1})$$

$$v/c = (q^2 - 1) / (q^2 + 1) \quad (9)$$

According to (1) and (8):

$$v_T = v q (1 - v/c) = v q^{-1} (1 + v/c)$$

therefore $v_T^2 = v^2 (1 - v^2/c^2)$

and, at last $v_T = v (1 - v^2/c^2)^{1/2}$. (10)

Thus the frequency of Ψ' is reduced by the factor $(1 - v^2/c^2)^{1/2}$, compared with the frequency of Ψ .

In this model, times and lengths are *defined* by frequencies and wave lengths of standing waves.

Therefore (10) means:

In a reference system S' that travels with velocity v relative to the reference system S , time passes slower by the factor

$$k = \sqrt{1 - \frac{v^2}{c^2}} \quad (11)$$

Now to the fundamental question of special relativity, which was introduced in section 2.3, i.e. the question of why all signals (or objects, or processes), which arrive simultaneously at an observer at rest, arrive at a moving observer always *with the same time difference* as light signals which were emitted at the same time and at the same positions.

As we postulate neither the validity of the principle of special relativity nor the constancy of light-speed for all uniformly moving observers, the equality of these time differences cannot be presupposed but must be demonstrated.

Let us first look at the resting system S. Let M be the medium point of the line segment LR.

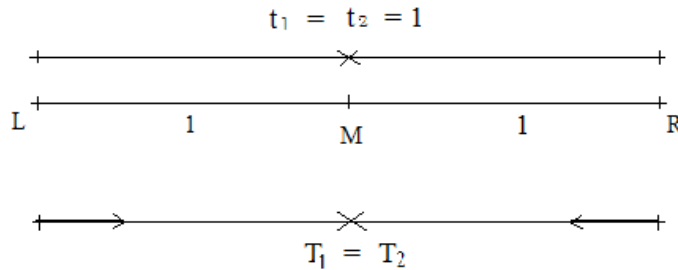

(S4)

The upper arrows represent light rays. t_1 and t_2 are the time points when the light rays from R and L arrive at M ($t_1 = t_2$).

The lower arrows represent objects, which travel from L and R towards M with equal velocity. T_1 and T_2 are the time points of their arrival ($T_1 = T_2$). The distances between M and R and between M and L are 1.

The object at L is represented by a superposition of waves with the frequencies $v_{\rightarrow} = a$ and $v_{\leftarrow} = b$, accordingly the object at R by a superposition of waves with the frequencies $v_{\rightarrow} = b$, $v_{\leftarrow} = a$ ($a > b$). At M, an object at rest is located with $v_{\rightarrow} = v_{\leftarrow} = m$.

Let v_L be the velocity of the object at L, v_R the velocity of the object at R ($v_L = -v_R$), and v_M the velocity of the object at M ($v_M = 0$).

Now we change over into a system S' which travels uniformly to the right with velocity $v_{M'}$. S' is defined in the following way: the *very same* objects as before in S – which however we denominate now L', M' and R' – are located at the same positions at the same time point $t = 0$, but *after an*

acceleration, that is: transformed according to (8). Thus their frequencies can be determined by multiplying or dividing the frequencies of the corresponding objects in S by a real number $q > 0$.

Now we will demonstrate, using this scenario, that the time difference of the arrivals of the moving objects is equal to the time difference of the arrivals of the light rays.

At first we calculate the time difference, with which the light rays emitted from L' and R' (simultaneously with respect to the system at rest) arrive at M'.

From the below outline

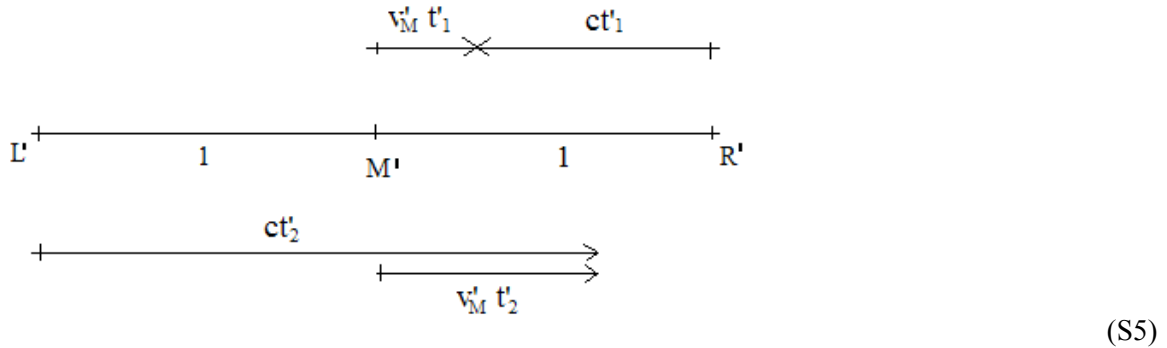

the following relationships can be read off:

$$v_M' t_1' + c t_1' = 1, \quad -v_M' t_2' + c t_2' = 1$$

According to (9) holds

$$v_M' = c (q^2 - 1) / (q^2 + 1)$$

Therefore

$$\begin{aligned} (c (q^2 - 1) / (q^2 + 1)) t_1' + c t_1' &= 1, & t_1' &= (1 / c) ((q^2 + 1) / (2q^2)) \\ -(c (q^2 - 1) / (q^2 + 1)) t_2' + c t_2' &= 1, & t_2' &= (1 / c) ((q^2 + 1) / 2) \end{aligned}$$

From this follows

$$t_2' - t_1' = (1/c) \left((q^4 - 1)/(2q^2) \right). \quad (12)$$

Thus this is the time difference with which the *light rays* arrive at M'.

Now to the time difference, with which the *objects* arrive at M'.

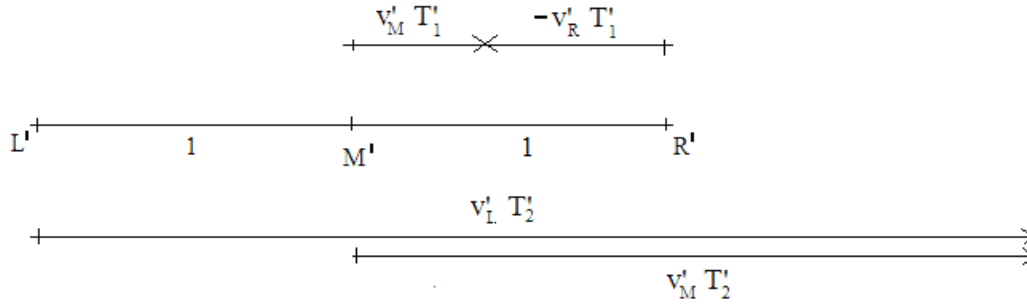

(S6)

$$-v'_R T'_1 + v'_M T'_1 = 1, \quad v'_L T'_2 - v'_M T'_2 = 1$$

According to (3) and (8) applies

$$v'_L/c = (a q - b(1/q)) / (a q + b(1/q)) = (a q^2 - b) / (a q^2 + b)$$

$$v'_R/c = (b q - a(1/q)) / (b q + a(1/q)) = (b q^2 - a) / (b q^2 + a)$$

As before, $v'_M = c(q^2 - 1)/(q^2 + 1)$

The short calculation leads to:

$$T_2' - T_1' = (1/c) \left((q^4 - 1)/(2q^2) \right). \quad (13)$$

The comparison with (12) shows:

$$T_2' - T_1' = t_2' - t_1'.$$

The time difference of the arrivals of the moving objects at M' is equal to that of the light rays.

Thus we have demonstrated:

If a resting system S is changed into a system S' by transforming all objects of S according to (8), then all symmetrical signals (processes, objects) – traveling at light speed or at any other arbitrary speed – which arrive at M in S simultaneously, arrive at M' in S' with the same time difference Δt .

Therefore, points located *ahead of* M' must be shifted into the past with respect to an observer in M', and points *behind* M' into the future.

2.8. Derivation of the Lorentz-Transformation

If *now* the measures of space and time are determined by light signals (on the basis of Δt), then this is *not* substantiated by the principle of special relativity and by the principle of the constancy of light speed for all uniformly moving observers, but by the fact that – due to the above result – it is *already known* that the spacetime measures determined by light hold true for all physical processes and events.

For the sake of simplicity, in the following we will omit the dashes of the primed quantities that belonged to the moving system, and also denominate v_M' as v .

The scenario is now again the one that Einstein invented. From L and R light rays are emitted, simultaneously with respect to an observer resting at M.

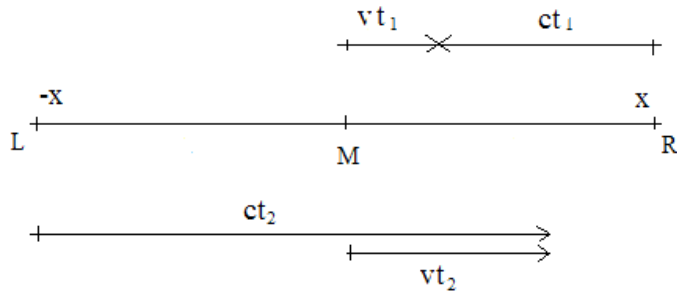

(S7)

The outline shows that

$$t_1 = x/(v + c) \quad t_2 = x/(-v + c)$$

$$t_2 - t_1 = 2vx/(c^2 - v^2) = 2(vx/c^2)/(1 - v^2/c^2)$$

Thus if, with respect to the resting observer, the signal from point R is emitted at the time $t_R = 0$, then, with respect to the moving observer, this time point must be shifted by the interval

$$(vx/c^2) / (1 - v^2/c^2)$$

into the past: the signal arrives at the moving observer earlier than at the resting observer. (Half of the time difference, because the origin of coordinates of both systems lies in the middle between L and R and the dependency from x is linear.)

Accordingly, with respect to the moving observer, the time point t_R° of the emission of the signal from R is given by

$$t_R^\circ = -(vx/c^2)/(1 - v^2/c^2)$$

Let us now assume, the signal is not emitted at the time 0 but at an arbitrary time t from a point located at the distance x from the resting observer.

Then, with respect to the moving observer, the x-coordinate of this point has been diminished by vt, and it follows (by plugging in the value of x and adding t)

$$\begin{aligned}
 t^\circ &= t - (v(x - vt)/c^2)/(1 - v^2/c^2) \\
 t^\circ &= (t - v^2t/c^2 - vx/c^2 + v^2t/c^2)/(1 - v^2/c^2) \\
 t^\circ &= (t - vx/c^2)/(1 - v^2/c^2)
 \end{aligned} \tag{14}$$

The coordinate x° that belongs to this altered time t° , results from

$$\begin{aligned}
 x^\circ &= x - vt^\circ \\
 x^\circ &= x - v(t - vx/c^2)/(1 - v^2/c^2) \\
 x^\circ &= (x - xv^2/c^2 - vt + xv^2/c^2)/(1 - v^2/c^2) \\
 x^\circ &= (x - vt)/(1 - v^2/c^2)
 \end{aligned} \tag{15}$$

Up to now, only the time shift along the x-axis has been taken into account. However it must also be factored in that, according to (11), in the moving system the time is passing slower by the factor k.

Therefore we set

$$t' = t^\circ \sqrt{1 - \frac{v^2}{c^2}}$$

Then follows from equation (14)

$$\begin{aligned}
 t' &= ((t - vx/c^2)/(1 - v^2/c^2)) \sqrt{1 - \frac{v^2}{c^2}} \\
 t' &= (t - vx/c^2) / \sqrt{1 - \frac{v^2}{c^2}}
 \end{aligned} \tag{16}$$

Lengths and times are connected by $x^\circ = ct^\circ$. Therefore also applies that

$$x' = x^\circ \sqrt{1 - \frac{v^2}{c^2}}$$

$$x' = (x - vt) / \sqrt{1 - \frac{v^2}{c^2}} \quad (17)$$

(16) and (17) are two of the four equations of the Lorentz-Transformation. About the other two, nothing further has to be said.

2.9. Additions

1. Basis of our considerations was the time difference Δt . However it would also have been possible to start with the formula for the velocity addition, which here, according to (9), assumes the following form:

$$\text{Let be } v = c(q_1^2 - 1) / (q_1^2 + 1), \quad w = c(q_2^2 - 1) / (q_2^2 + 1)$$

Then it can be shown by a simple calculation that the combined velocity W , which is composed of v and w , is given by

$$W = c \frac{q_1^2 q_2^2 - 1}{q_1^2 q_2^2 + 1} = \frac{v + w}{1 + vw/c^2}$$

(At last I should mention that q corresponds to the factor of the relativistic Doppler effect:

$$\text{from equation (9) follows } q = \sqrt{\frac{1 + v/c}{1 - v/c}})$$

2. In the above considerations, special relativity has been derived from the assumption that there is nothing but light speed.

The train of thought that leads to the insight that there can be only one single velocity has been performed *without any physical premises*. Special relativity thus appears as a result of a series of ontological conclusions.

Here is a short recapitulation:

The first step is to realize that the relationships between the times that apply at different positions cannot be substantiated by a hypothetical entity called *universal time*, but must be mediated by physical processes: If I am *now here*, and I want to know *which time (out) there* is, then the only way to find that out is using signals or processes.

Times determined in this way change with the state of motion of a system: signals used for determining these times arrive at an observer A not at the same points in time as an observer B who is moving relative to A.

The achieved results must meet the *postulate of uniqueness*: independent of the kind of signals used for determining the times, for every observer – with respect to his reference system – the operation must lead in any case to identical results.

With this, we have arrived at the point where the conclusions of sections 2.3, 2.4 and 2.5 come into effect: the demand of uniqueness can only be met *if there is just one single velocity*. This means: *Reality consists of fundamental processes which propagate at the same speed*. (It is also possible that there is only one such process.)

From the considerations of sections 2.6 and 2.7 follows that these fundamental processes have to be *wave-like*. Therefore, all other velocities must be generated by wave superpositions.

This means: everything which exists – every object and every interaction – is ultimately a superposition of the fundamental wave-like processes. The limit of their velocities will then of course be the speed of the waves themselves.³²

³² In the Second Part, these statements will be derived once again, however from completely different preconditions.

As demonstrated in 2.7, in a reality determined in this way the postulate of uniqueness of the times at different positions with respect to any reference system is met. And at last, according to (8), the transformation between systems moving relative to each other is the Lorentz-Transformation.

2.10. What has been achieved?

1. The relativistic space and time phenomena are completely evident.

The assumption: "Everything which exists and which occurs is a superposition of waves with light speed" makes it possible, to *construct* and thus to understand the relativistic space and time measures on the basis of reality *as it is*, that is: dynamics of objects in three-dimensional space.

With this, it is no longer necessary to *justify* the principle of special relativity. This is especially important as this principle can actually *not at all* be justified within the framework of the usual model conceptions. As follows:

If there is no motion against space but only relative to objects, then this must apply to *any* motion, thus also for accelerated motion. Against space, also acceleration cannot be defined. Therefore, there is no reason for the distinction of uniformly moving reference systems.

The theory of general relativity does *not* solve this problem. It represents a generalization of the theory of special relativity only with respect to permitted coordinate systems but not with respect to the relativity of motion: this relativity is *not* extended to accelerated systems by GR. In actual fact, as a consequence of acceleration, *inertia forces* occur.

Of course these forces can be treated as if they were the consequence of a time-dependent gravitational field – however this is a purely formal act. Is relativity of accelerated motion demonstrated by this act? Not at all! – there *is* just no gravitational field, and the question remains open, *what* the accelerated motion must be related to and *why* uniform motion is distinguished by nature.

First it may seem that Mach's proposal – that motion is to be defined relative to the masses in the universe – was a way out. Then the assumption of motion against space could be dispensed with. However if mass should serve as reference point for accelerated motion, then not only motion itself but also the phenomenon connected with it, that is: *inertia*, has to be related to the surrounding mass.

However also in GR, the total mass that surrounds an object that is accelerated (e.g. rotating) relative to this mass, is not the source of the inertia caused by the acceleration but contributes to it just a small part.³³

Thus, against general conviction, the result of Einstein vs. Newton as regards relativity of motion is 1:1, a draw: uniform motion is *relative*, accelerated motion is *absolute*. However this is of course not a possible result but a contradiction within the concept of relativity of motion; and this means that the principle of special relativity cannot be substantiated consistently within the framework of the usual physical conceptualizations.

However in actual fact, the principle of special relativity *does* apply. But as clear and simple the idea may seem that motion against space cannot exist and that *therefore* motion has to be relative – it is still impossible to derive the relativity principle from this idea.

This problem disappears with our approach. Here, the relativity principle does not represent the necessary starting point of SR. It is substituted by the basic assumption: "There is nothing but light speed", from which ensues the direct construction of the relativistic spacetime relationships, as was demonstrated in the previous sections. The problem of motion does not appear at all, because motion is *defined* as interference phenomenon and, as such, behaves *inherently* in a relativistic way. From this *follows* the principle of special relativity.

2. A consequence of the interpretation of SR presented here is the maximal extension of the nomological status of light speed and, accordingly, of the importance of the natural constant c . In this regard, the assertion "There is nothing but light speed" cannot be outperformed.

3. If there is nothing but light speed, then particles are wave superpositions. From this ensues directly that the quantities energy and momentum must be defined by frequency and wave length, and that acceleration is tantamount to frequency alteration. Moreover, the derivation of de Broglie's matter waves in 2.6, shows that for defining momentum a phase wave-length is needed.

4. Formally, SR is nothing but a system of transformation equations. Einstein adopted it from Lorentz. The only – but indeed very important! – difference was the interpretation: The one of Lorentz was *ad hoc*: he saw the cause for the alterations of time and space measurements in a mechanical deformation of the ether which had – without any reason, purely by chance – just the value needed for canceling

³³ See e.g. H. Thirring: *Über die Wirkung rotierender ferner Massen in der Einsteinschen Gravitationstheorie*, Phys. Zeitschr. 19, 33 (1918).

out any difference of light speed measurements performed by moving observers (e.g. in the Michelson Morley experiment). Einstein's interpretation, on the contrary, was based on general principles. Only through this interpretation, the Lorentz transformation could become the foundation of modern physics.

Now, this transformation is again re-interpreted, in fact in a way by which the hitherto existing, purely formal view is deepened through the knowledge of the context of justification.

As regards the transformation itself and its applicability to all physical phenomena, nothing changes. However, by virtue of this new knowledge, for the first time the fundamental layer of reality comes in sight, and surely it need not be specifically emphasized that the consequences will be at least as serious as with the first interpretational changeover: at one blow, the conceptual basis of physics changes, and our view of reality is radically transformed.³⁴

2.11. Some philosophical Remarks

The Problem of the Relation between *Existence* and *Time* in Physics

Any conception of reality whose constitutive elements are *space* and *material objects*, i.e. elementary entities existing *in* space, imposes a fundamental restriction on our understanding of time.

Here, the concept of a material object is *timeless*. Therefore, in a worldview of this kind, the concept of *existence* is also timeless.

The mental picture of a material body is *without* time. Time is added to this picture as a further, different element. There is existence, *and* there is time.

Newton formulates explicitly: "*Absolute, true, and mathematical time, in and of itself and of its own nature, without reference to anything external, flows uniformly...*" Thus it is not necessary that anything *moves* – time flows by itself.

Though this conception of time is corrected by quantum mechanics and by the theory of relativity – by quantum mechanics, because the energy cannot become zero, and by the theory of relativity, because space and time are united formally to spacetime – there still remains the idea of *something which*

³⁴ At this moment, nothing more can be said. All considerations of the First Part are pointing to this new vision of reality. In the Second Part, it will assume a more clear shape.

moves; and this "something" – if it is *without* motion, so to speak *purely existing* – is still timeless. In this conception, the idea of *timeless material existence* is conserved. (Motion is only an accident of that which exists.)

So this concept of existence lacks the relationship with time. Within the interpretation network of standard physics, this conceptual separation is uncorrectable.

In the model presented here, reality is *dynamic form*. Unlike a particle, a wave is *unthinkable* without motion. Thus there is no reality without motion, and accordingly also not without time. Therefore, time is not an *additional*, but a *necessary* element of the concept of existence. Its "flow" does not follow from its nature – in this case it would remain a mystery – but from the definition of reality. There is no longer the idea of objects as material entities which could move or not; Reality *is* motion.

What is Time?

"Time" is an entity which, though we use the term quite carelessly, is ultimately inconceivable.

In contrast, the entity "motion" can be understood intuitively . We know what motion is.

Due to the hypothesis "There is nothing but light speed", not only any kind of dynamics but also any kind of existence is bound to a motion with invariable speed. Thus it is possible using *motion* instead of *time* as basic concept.

Reality will then be *space and motion* – just in the way in which it has been designed in this chapter already from the beginning.

Formally, nothing changes. However now we know what time is. As a fundamental concept, it is inaccessible to us; but as a derivative concept which originates from the concept *motion*, it can be understood.

This modification affects the very basis of our view of the world. Of course we will continue to use phrases like "time passes by". However because of the inaccessibility of the concept "time", such statements hitherto have been just associatively connected with changing circumstances, but in fact it has been completely unclear *what* that actually is which "passes by".

But now, this statement has a meaning which is mediated through the concept of motion. All the changes and transformations that objects undergo *in time*, are manifestations of one perpetual motion, which forms, alters and dissolves patterns.

Substance or Form?

If matter is thought as consisting of particles, then it is *static*. If it is thought as consisting of waves, then it is *dynamic*.

Then, however, it is no longer appropriate to state that matter *consists* of waves – rather it must be seen as a perpetual dynamic process of generating and maintaining shape.

Therefore, what remains identical over time is not the *substance* of an object but its *form* – as stationary (or near-stationary) wave state.

2.12. What remains open?

The theory of special relativity contains a conceptual defect, which we have not eliminated. It manifests itself in several different ways. The simplest way to reveal it is by posing the question:

*What oscillates actually in the case of light waves?*³⁵

The answer: "The electrical and magnetic field vector" cannot be accepted – that would be the same as if, in the case of water waves, the water were removed and then stated that now kinetic and potential energy take the place of the water. The *subject* of the periodic change, which is the basis for the wave propagation, cannot simply be replaced by general description quantities.

The same question appears also as *the problem of mediation*:

Two spaceships are located at a great distance from one another. The question is:

What is it actually, which provides for the correct – which means: relativistic – progress of time in both spaceships? By what is the connection between the two systems mediated?

³⁵ Due to the aforementioned identification of reality and description, this question has disappeared from the awareness of physicists. But light *is not* just a wave equation – light *exists!*

Here, the theory of special relativity does not offer anything. The absolute reference system has disappeared, and instead there are only coordinate systems. But a coordinate system does not exist – it cannot mediate anything.

This question about "what" – i.e. about the subject of the oscillation that generates the light waves, or about the subject that mediates the progress of time – appears especially clear in the following scenario:

Think of a closed two-dimensional universe, the geometric structure of which is that of a spherical surface. In this universe, there are two observers, who move uniformly relative to each other along the same great circle. At their first encounter, they set their clocks to 0. The question is: *What will be the result of the clock comparison at their next encounter?*

There is in fact no answer. Both A and B travel on geodesics. As seen from A, time passes slower at B, as seen from B, time passes slower at A. The situation is completely symmetrical.

Of course we can also introduce other observers, who travel along the same great circle with different velocities. Each of them has the same right to judge the circumstances with respect to his reference system and, accordingly, to expect another result of the clock comparison. Only an *actually performed* comparison can inform about how the different observer times are *in fact* related to each other.

Among all possible observers, there is exactly *one*, whose judgment was correct. It is the one, whose time passes most quickly. His reference system is *in fact* the absolute frame of reference.

If we now opened the great circle and extended the ends to infinity, then the situation would change completely: A and B would then encounter a second time only if one of them turned around, whereby the symmetry would be lost. Everything would remain relativistic. However if we closed the ends again, we would again be compelled to introduce the absolute reference frame. A most peculiar circumstance: The topology of the universe, i.e. a *global* attribute, determines directly what the case is *locally* (the respective time).

Doesn't this introduction of a system at *absolute* rest, which is in fact necessitated here, suggest a re-institution of the ether – all the more, as the contradictions of the old ether theory would be eliminated by the assumption that there are only waves?³⁶

³⁶ The problem of the ether was that, on the one hand – due to the high value of the light speed – it would have had to be very hard, and, on the other hand, it should have offered no resistance to material bodies. Obviously an absurd concept! In a model in which no particles exist but only waves, this contradiction would be eliminated.

Though this conclusion seems indeed unavoidable, it is actually not necessary. In the Second Part it will be answered why – together with the question of what oscillates in light waves and by what the relativistic time relationships are mediated.

2.13. Michelson-Morley: The Overlooked Opportunity

The experiment, which Michelson and Morley performed in 1887, was meant to measure the velocity of the earth relative to the ether. Since they found no difference between the velocities of light in different directions, they considered their experiment failed.

Currently, however, the following conclusion is held to be correct: The constancy of the speed of light for all uniformly moving observers is a natural law, the ether does not exist, and light does not require a medium for its propagation.

Here, it was shown that there is a further option: the medium exists, but there are no particles – at least not in the form in which they are presently understood –, but only waves. The constancy of the speed of light is not set by natural law, but derived.

Thus the alternative in which we find ourselves reads as follows:

A: We abandon the assumption of a medium for the light waves.

B: We abandon the assumption of indivisible *substantial* objects that are always identical with themselves.

Alternative A – even if it is held to be true for more than a century and thus seems a matter of course –, must ultimately be suspected to be merely an ontological aberration: a wave without medium is nonsensical. Such an assumption can only be eligible if it is inevitable because there is no alternative.

However, there *is* the alternative B, and, as it will turn out in the following, B is reasonable and well founded – although it contradicts beliefs that lasted for more than a century.

In the case of A, it is impossible to understand the relativistic phenomena. Relativity is a purely formal fact.

By contrast, in the case of B special relativity can be derived *and* explained.

3. Local and objective Interpretation of Quantum Theory

3.1. Preliminary Note

The simplest way to outline the structure of quantum theory and, at the same time, to demonstrate the problems of its interpretation, is via paradigmatic application cases. Prior to quantum mechanics, such examples served for understanding the connection between the respective formalism and the underlying *actually occurring* physical process. But in quantum mechanics they serve the opposite: they are meant to demonstrate that the attempt to explain which real events are hiding behind the formalism is pointless.

Therefore, as introduction, two well-known scenarios shall now be presented – at first in the usual form to expose once more to which strange, not to say: absurd assumptions nature seems to compel us. Such a reminder is perhaps not completely superfluous – the frictionless working of the quantum mechanical formalism could easily push the interpretation problems all too far into the background.

Afterwards, step by step the tools will be developed which are needed for a local and objective interpretation of quantum mechanics. Later, the same scenarios – and some other ones – will be placed into the new interpretational framework and explained in such a way that all absurdities are eliminated and it becomes comprehensible what *actually* happens. Moreover, the new interpretation does not only avoid the oddities of the usual view but is even closer to the formalism.

As just before, in the explanation of special relativity, formal tools can almost completely be dispensed with; it is again a purely interpretational issue.

3.2. Introduction: two Examples

Paradox of the Two Paths

Let us look at the following experiment:

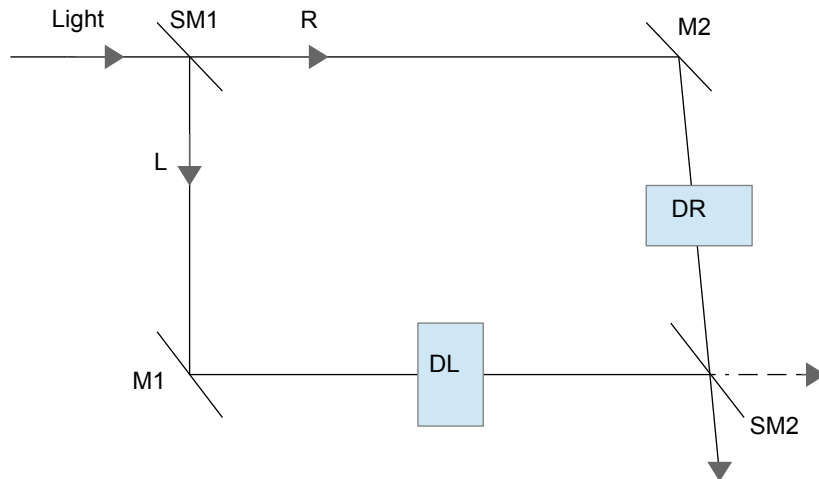

(S1)

A light ray (starting top left) passes through the depicted test arrangement. The intensity of the light is chosen so low that almost certainly only one single photon is present within the diagrammed area.

At first the light crosses the semi-permeable mirror SM1. On both paths L and R it is redirected by mirrors M1 or M2 in such a way that the rays reunite at a second semi-permeable mirror SM2. The lengths of the paths L and R differ, such that at SM2 the phase of the ray propagating along L does not coincide with the phase of the ray propagating along R and one of the two rays disappears due to destructive interference. In both paths photon detectors (DL and DR) can be inserted.

The experiment reveals the following – in the common approach unsolvable – absurdity:

If the detectors are *not* in the light paths, then we observe *interference* after the second semi-permeable mirror, that is: the photon – or the light wave – must have taken both ways; otherwise interference would not be possible.

This fact deserves particular attention:

*There must **always** be something underway in both paths – otherwise one could not observe interference after the second semi-permeable mirror if both paths are free.*

However if we now insert the detectors into the paths, then in any case only *one* detector at a time responds: since the photon is indivisible, it can only choose *either* L *or* R (with a probability of $\frac{1}{2}$ each).

This fact deserves particular attention too:

*There can **never** be anything on the way in both paths at the same time, because the two detectors do never respond simultaneously.*

Obviously these two facts contradict each other.

How is this contradiction "solved" within the standard interpretation? In the following way:

If a photon appears in one of the detectors, the wave phenomenon on the other path is vanishing instantaneously! – it is considered kind of non existent, it has been nothing but a "probability amplitude", whatever that means.

This is the so called *reduction of the wave function*: Only one of the diverging wave-like possibilities – in our example there are only two – becomes real, and all others vanish instantaneously, no matter how distant they may be.

If the amplitude squares of these quantum mechanical probability waves only represented probabilities, as in a dice game, then there wouldn't be a problem – nothing would vanish because in any case there would exist but one reality: namely the dice on its way, from the very beginning of the cast, and because the probability of one sixth for each option would only point to the fact that we simply don't know the definite path of the dice.

However Quantum mechanical possibilities cannot be interpreted like that: They *interfere* – there is interference if the detectors do not stop the light rays. This *must* imply that something exists in both paths. And something which exists cannot just vanish!

Still, it does vanish. And we have to resign to this fact – at least according to general conviction. Indeed this paradox is not conceived to explain anything but rather to demonstrate that nature behaves in a way which is totally incomprehensible to us.

But hold on! Perhaps the photon "knows" what we are doing? If the information whether the detectors are inserted or not existed in some way at the first semi-permeable mirror SM1, then the photon could decide whether to take *one* way or *both*.

But even this conjecture – which itself does not seem very plausible – does not offer a solution to the problem.

This is because we can defer the decision whether or not to insert the detectors into the light paths up to the moment when the light has already passed the first semi-permeable mirror, that is: after the decision whether it takes only *one* or *both* ways has already been made. Also in this case, the experiment proceeds in the same way: without the detectors, we observe interference, but if the detectors are inserted, no simultaneous response but a random sequence of alternating events in both detectors occurs. However, as the decision whether the light takes one or both paths must already have been made, we seem to be able to determine retroactively what it does – or has done.

The formulations offered by the standard interpretation do not clear up anything, rather they remind of flower-garlanded speech bubbles. E.g. it is stated: "The events cannot be described isolated from each other. They form a single entity which is divided only by measurement." Or: "Nothing is an event before it is observed."

In actual fact, such statements do not at all mitigate the absurd rigidity of the paradoxical, essentially unacceptable fact that in this scenario – just as in all quantum theoretic descriptions – something which gives proof of its existence by interference is vanishing, and that this disappearance happens *without any physical causation*.

At that, this disappearance is supposed to happen *simultaneously* with the measurement, that is: *at any given distance without any delay*, where it is actually not clear what that means: In the case of observers moving relative to each other – would there occur a difference of the time points when all probability waves disappear, which do not become real?

Enough with these absurdities! Surely it has become clear that the reasons by which the physicists felt themselves compelled to accept the just depicted circumstances *as an interpretation* instead of seeing them as a *reductio at absurdum*, must be judged based on the question if they are indeed strong enough to justify such an extreme decision, and that any alternative, which avoids such bizarre assumptions, must be favoured.

Double-Slit Experiment

Let us again hear Richard Feynman:

"In this chapter, we shall tackle immediately the basic element of the mysterious behavior in its most strange form. We choose to examine a phenomenon which is impossible, *absolutely* impossible, to explain in any classical way, and which has in it the heart of quantum mechanics. In reality, it contains the *only* mystery. We cannot explain the mystery in the sense of 'explaining' how it works. We will *tell* you how it works. In telling you how it works we will have told you about the basic peculiarities of all quantum mechanics."³⁷

So much to the *status quo*. Now to the description of the experiment:

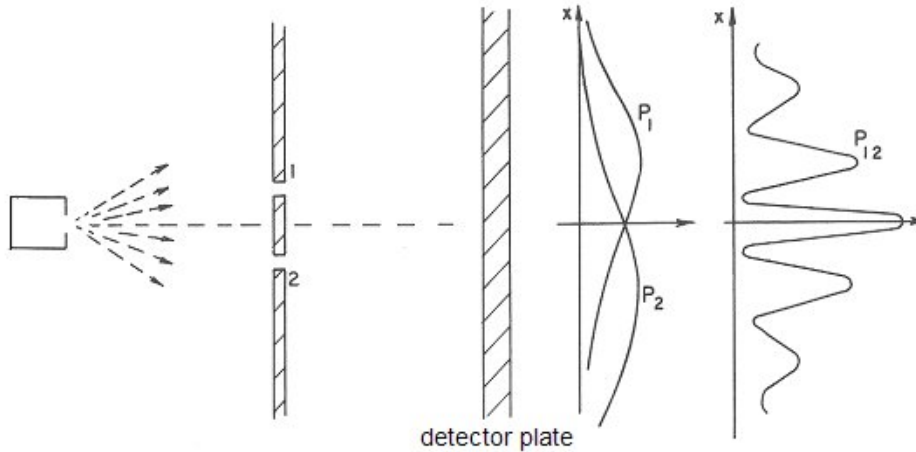

(S2)

On the left side of the outline there is a device for generating some kind of particles, e.g. electrons (or photons, or whatsoever. The following applies to *all* kinds of particles). If this apparatus is activated, then at the detector plate an erratic sequence of dark points will appear. However in the course of time, the well-known interference pattern will emerge. (P_1 shows the distribution of the points if only slit 1 is open, P_2 if only slit 2 is open, $P_{1,2}$ if both slits are open.)

³⁷ Feynman, Leighton, Sands, "Lectures on Physics" Vol. 1, 37–2, Addison-Wesley 1965.

Usually, the collapse of all attempts at explanation is described in the following way:

On the one hand, electrons (or photons etc.) occur only as indivisible units. Thus they must be described as particles, which means: they pass *either* through slit 1 *or* through slit 2. But $P_{1,2}$ is not the sum of P_1 and P_2 – there is interference, which is impossible in the particle image. Thus we must, on the other hand, use the wave image of electrons in order to describe this interference. In *that* picture, a wave passes through both slits, is diffracted by them, then interferes with itself, and at last arrives at the detector plate. Depending on the distance between the plate and the double slit, this wave can be arbitrarily extended.

However now we do not observe a continuous gradual increase of the plates blackening according to $P_{1,2}$ but a sequence of narrowly localized events, that is: of single tiny black spots each of which is triggered by a single electron, which now, accordingly, corresponds again to the particle image. Only a great number of such local events will form the interference pattern.

Once the particle manifests itself, the whole wave phenomenon disappears instantaneously. (This is again the *reduction of the wave function*: again only one of all wave-like expanding possibilities remains, that is: the one which becomes the observed event. All others disappear.)

Particle image and wave image are incompatible. However both are required for the description. Thus we seem to be forced to admit the limitation of our concepts and our reasoning and retreat into the mathematical scheme.

Surprisingly, this scheme is very simple: the procedure is described by a function Ψ . Ψ satisfies a wave equation. In fact, $P_{1,2}$ corresponds exactly to the distribution which would also occur due to the interference of normal waves – of course with the exception that in the case of normal waves, a continuous increase of the blackening would be observed and not a sequence of point-like events.

For this reason, the amplitude of Ψ is not interpreted as amplitude of an actually existing wave but as a so-called *probability amplitude*. Its square specifies the probability (or in the continuous case the probability density) of the events.³⁸

³⁸What *actually* happens in the double-slit experiment, is explained in [Section 3.6](#).

3.3. *Back to the Roots*

Before 1900, the physical reality was divided into two categories of phenomena, which were based on different model conceptions: the ones that exhibited wave-like and the ones that exhibited particle-like behavior. However on this basis it was impossible to describe the interaction between light, which was seen as a wave, and matter, which was conceptualized as consisting of particles, in accordance with the experiment. For that it seemed necessary to assign particle attributes to light. Not much later it was realized that reversely wave attributes must be assigned to particles too.

Suggested by some observations, antecedent to quantum theory a new classification of the phenomena was established: At any kind of motion – e.g. propagation of radiation, motion and distribution of atomic or sub-atomic particles – objects were supposed to behave wave-like, which manifests itself particularly by diffraction and interference, whereas at interaction processes – absorption and emission of light, acceleration of electrons by electromagnetic radiation, diffraction of light on electrons – objects were expected to act particle-like.

The connection between the two models, which now *both* – though they are incompatible – had to be applied to all objects in the microcosm, was regulated by the equations

$$E = h\nu \quad \text{and} \quad p = h/\lambda$$

where h is the constant that Planck had determined in his attempt to describe the black body radiation. (He succeeded only under the condition that an oscillator with frequency ν cannot absorb any amount of energy but only integer multiples of the energy $h\nu$.)

Because of the wave-character of particles – more precisely due to the definition of momentum by an inverse wave-length – the simultaneous existence of position and momentum got lost. The minimum of uncertainty of their simultaneous determinability was given by the equation

$$\Delta x * \Delta p \geq h$$

– the so-called *uncertainty relation*.

I assume you are asking yourself why this is told here once again. This has the following simple reason:

The structure of quantum theory ensues from the fact that it integrates all the just mentioned experimental experiences.

Therefore, if one aims at re-interpreting quantum theory in a new way without changing its formal structure, then it is necessary to first re-interpret exactly those experiments, which gave rise to it and could be described by it.

This will be carried out in the following.

In the opinion of the majority of physicists, the theoretical constructs of physics in the first decades of the 20th century must be understood as results of a series of formally and logically necessary steps. I do not wish to repudiate this. Much rather I try to show that the *initial* step was wrong and that, accordingly, the mistake has always been *presumed* from the very beginning.

So let us turn towards this initial step and reconsider, after more than a hundred years, the question about the nature of the interaction between light and matter, as it presented itself to Albert Einstein in the year 1905.

3.4. The Photoelectric Effect

The experimental facts of the photoelectric effect:

If a metal plate gets irradiated by UV-light with a frequency ν above a certain limit ν_{\min} , electrons are set free without any delay. The kinetic energy of these electrons depends only on the frequency ν of the radiation.

This is in blatant conflict with the wave model of the light, according to which the displacement of electrons should take place at any light frequency and their energy should depend on the intensity of the light. Furthermore, an enormous delay (under realistic conditions thousands of hours) until the displacement of the first electron would have to be expected, if one assumes that the energy radiated onto an area of the extent of an electron cross section should have to mount up to the required value.

As is well known, Einstein's solution was to assume an interaction between light and matter in the form of an *impact process* of particles, i.e. of a light-quant with the energy $h\nu$ and an electron bound with the energy A . Then from the energy balance the following equation results:

$$h\nu = A + mv^2/2 \quad (\text{A ... displacement work}) \quad (1)$$

This equation describes the process in accordance with the experiment. Insofar it is justified to call this a correct and successful description.

However one would surely prefer to know *how* this magic metamorphosis of a wave into a particle occurred – at least it is decisively proven that light is a wave.

For comparison, imagine the following scene: a magician places an empty top hat on a table, puts a trumpet into it and speaks his magic formula – and out of the hat jumps a pig! – And now all you know is the velocity of the pig. In spite of the undeniable benefit – you would probably be able to sidestep the next pig – you would hardly be content with this knowledge!

What really matters is that, in this case, indeed nobody would assume that the trumpet has *actually* been transformed into a pig. Why not? Plain and simple: there is no magic.

So why do we accept the transformation of the wave into a particle as a fact?

The usual commentary – which pretends to be an explanation – reads as follows:

Our thinking applies only to the medium-sized world. It is not suitable for understanding anything very small.

Let us simply replace this untenable assertion, which, as a standalone assumption, is out of thin air, by the general

No-Nonsense Hypothesis: There is no witchery. There is altogether no nonsense within nature.

Armed with this hypothesis, we turn again to the Photoelectric Effect.

It is completely ascertained that light is a wave. Therefore *it is* a wave. And as there is no witchery, it does *not* turn into a particle – thus it must enter the interaction as a wave.

On the other hand, we know that it is not possible to describe the Photoelectric Effect as interaction between wave and particle.

This means there is only one way out: the electron must be a wave too.

But the electron is a particle! So, with the assumption that now it is a wave, aren't we also guilty of believing in witchery?

Not at all. As follows:

A particle is not *logically* associated with its attributes (interactions) but *only by definition*. Accordingly its definition changes, if the description of the interaction changes. This means: if we succeed in describing the interaction under the assumption that the electron is a wave, then its definition has changed – in other words: then it has already before been a wave.

In contrast, a wave is *logically* associated with its attributes (interactions): its attributes *ensue* from its dynamics. Thus with a wave, there is no possibility for another definition. A description of the interaction, where the wave appears as a particle – as is the case in Einstein's model – can therefore not change the definition of the wave; in this case the assumption of a transformation – i.e. of duality – is unavoidable.

Thus the No-Nonsense Hypothesis has led us to the assumption that both light and electron are waves.

How can waves interact *as waves*?

The easiest way is by superposition. Thus we will describe the interaction as superposition of the two waves.

At first a preliminary consideration. Let us assume, in an electron exists an oscillation with frequency ν . What follows with respect to this oscillation, if the electron is at rest? It follows that the oscillation is in-phase, because if the oscillation has everywhere the same phase, then there is no motion. Therefore, for an electron at rest, we must set:

$$y = \cos 2\pi t \nu$$

(This is de Broglie's well-known train of thought.) Then for an electron with velocity v the Lorentz-Transformation leads to

$$y = \cos 2\pi \left(t \nu \frac{1}{k} - x \nu \frac{v}{c^2} \frac{1}{k} \right) \quad \left(k = \sqrt{1 - \frac{v^2}{c^2}} \right)$$

Thus the frequency ν_e of an electron moving with velocity v relates to the frequency ν_{e_0} of an electron at rest as follows:

$$\frac{\nu_e}{\nu_{e_0}} = \frac{1}{\sqrt{1 - \frac{v^2}{c^2}}} = \frac{1}{k} \quad (2)$$

In the case of non-relativistic electrons, v is small against c , and therefore

$$\frac{1}{k} = \frac{1}{\sqrt{1 - \frac{v^2}{c^2}}} \approx \frac{1}{1 - \frac{v^2}{2c^2}} \approx 1 + \frac{v^2}{2c^2} \quad (3)$$

Now we proceed to the description of the interaction. At first, we look at the interaction between light and a free electron.

Let ν_{e_0} be the frequency of a free electron at rest before the interaction, ν_e the frequency of the electron moving with velocity v after the interaction.

We form a superposition of the in-phase oscillation which represents the electron³⁹

$$y = \cos 2\pi t \nu_{e_0}$$

and a plane wave that represents the light

$$y = \cos 2\pi \left(t \nu_L - x \frac{1}{\lambda_L} \right)$$

From the identity:

³⁹ Of course it cannot be claimed that the electron *is* this oscillation. However from the occurrence of this oscillation conclusions can be drawn.

$$2 \cos a \cos b = \cos(a + b) + \cos(a - b) \quad (4)$$

follows that, as a consequence of the superposition, we obtain two waves with the frequencies

$$\nu_{e_0} \pm \nu_L$$

(where ν_L is the frequency of the light).

The higher frequency must be the frequency of the electron *accelerated* by the interaction; thus, according to (2), it follows that

$$\nu_e = \nu_{e_0} + \nu_L = \nu_{e_0} \frac{1}{k} \quad (5)$$

(The second wave will be discussed subsequently)

Then $\nu_L = \nu_{e_0} \left(\frac{1}{k} - 1 \right)$ and according to (3)

$$\nu_L = \nu_{e_0} \frac{v^2}{2c^2} \quad (6)$$

Thus also here, the square of the speed of the electron is proportional to the frequency of the light.

(For the second wave we would have to set

$$\nu_e = \nu_{e_0} - \nu_L = \nu_{e_0} k \quad (5')$$

However according to (3) $k \approx 1 - \frac{v^2}{2c^2}$

and we obtain again $\nu_L = \nu_{e_0} \frac{v^2}{2c^2}$

The frequency of the second wave would therefore correspond to the frequency of an electron, whose velocity is *reduced* by v as a consequence of the interaction. Since we assumed a stationary electron – so that v_{e_0} cannot be reduced any more – this part can be omitted.)

Up to now, we have only used simple wave-mathematics. In order to return into the world of physical modeling, we multiply (6) by h :

(It should be emphasized, however, that this multiplication is only necessary due to "dimensional" reasons, i.e. for crossing over to the "mechanical" description. The fact that h is a fundamental *unit* has nothing to do with our considerations. We will discuss this point later.)

$$h\nu_L = h\nu_{e_0} \frac{v^2}{2c^2} = m_e c^2 \frac{v^2}{2c^2} \quad (6')$$

Eventually we obtain

$$h\nu_L = \frac{m_e v^2}{2} \quad (7)$$

In order to transfer our idea to the interaction between light and a bound electron, now we only have to insert the frequency difference δ_ν between a bound and a free electron into (5)

$$\nu_e = \nu_{e_0} + \nu_L - \delta_\nu = \nu_{e_0} \frac{1}{k} \quad (8)$$

and to carry along this δ_ν , therefore

$$h\nu_L - h\delta_\nu = h\nu_{e_0} \frac{v^2}{2c^2} = m_e c^2 \frac{v^2}{2c^2} \quad (8')$$

So we get to

$$h\nu_L = \frac{m_e v^2}{2} + h\delta_\nu \quad (9)$$

which is identical with (1).

Let us now compare the two models – the usual one, which is analogue to a mechanical impact, and the one proposed here, which is conceptualized as wave-superposition.

In the mechanical impact model, the fact that the velocities and, accordingly, the energies of the electrons after the interaction are always identical and depend only on the light frequency necessitates the well known interpretation, i.e. light particles, which are defined by frequency and are always identical and indivisible, interact with electrons. (If the light particles were divisible or different from each other we should see also electrons with different velocities after the impacts.)

In the wave model, on the contrary, this fact is self-evident: here, the "electrons" leave the metal plate in a continuous process, *as waves*, whose frequency follows from the superposition of light waves and electron waves. Thus, according to equation (4), after the interaction no other frequencies (i.e. no other energies and velocities) are possible – wave superpositions do not permit other results.

This means: in the wave model it is obvious why the amplitude of the light and its intensity don't matter, and also why no delay occurs until the first measurement takes place: the superposition process starts immediately.

The assumption of indivisible light particles can be dispensed with.

However the most important point is the following one, because here for the first time the core of the new interpretation becomes visible:

The equation
$$v_L = v_{e_0} \frac{v^2}{2c^2} \tag{6}$$

contains already the essential result: the square of the velocity of a free electron after the interaction depends only on the frequency of the light (in the case of a bound electron, on the left side the term – δ_v has to be inserted).

For the derivation of this equation, only two presuppositions are required:

1. Both light and electron are waves.
2. The Lorentz-Transformation applies.

Besides these two, *no other physical prerequisites* are needed.

Only after the multiplication by h, that is: at the step from (6') to (7):

$$h\nu_L = h\nu_{e_0} \frac{v^2}{2c^2} = m_e c^2 \frac{v^2}{2c^2} \quad (6')$$

$$h\nu_L = \frac{m_e v^2}{2} \quad (7)$$

and for the physical interpretation of (7), the concepts *energy* and *mass* are required, as well as the relation between those concepts and the frequency

$$h\nu = mc^2 = E$$

In other words: For the description of the interaction between light and electron in the Photoelectric Effect the assumption is sufficient that both partners are waves. Not only the assumption of light quanta is superfluous, indeed *all* physical concepts and relations can be dispensed with. Only at the transition to a mechanical description of the usual kind, the concepts appear, which otherwise are the indispensable basis of the description: mass, kinetic energy, total energy.

Therefore, here the descriptions by waves and by particles are not at the same level. Instead they have a hierarchical relationship: The wave description comes first – it is *fundamental*, the particle description is subordinated – it is *derivative*.

Thus in this case the equations $E = h\nu$ and $p = h/\lambda$ do not prove the wave-particle dualism; they are **definition equations** of the quantities energy and momentum.

The concept *energy* is **reduced** to the concept *frequency*, and the concept *momentum* to the concept *wave-length*.⁴⁰

It is obvious that, if this interpretation, which arises quite naturally at the Photoelectric Effect, is sustainable, then *formally* nothing changes, but conceptually *everything* changes.

⁴⁰ However this reduction is only complete, if mass is eliminated as an independent concept, so that h loses its role as link between the wave- and the particle-realm. This will be carried out in the Second Part. (In 6. A Universe without Mass.)

Let us summarize. It has been demonstrated that the Photoelectric Effect can be described in two ways:

1. According to the mechanical impact model. Both interaction partners are understood as particles.

Then either a *dualistic* position has to be taken (quanta which carry the whole energy are embedded in the waves – this was the point of view of Einstein, de Broglie and later of David Bohm), or *complementarity* has to be assumed (this is the so-called Copenhagen interpretation). The dualistic position leads to explicit non-locality, the Copenhagen interpretation leads to the relinquishment of any kind of understanding.

2. By superposition of waves. Both interaction partners are understood as waves.

Concerning radiation, the interpretation difficulties connected with the positions mentioned in Point 1 disappear. Neither dualism nor complementarity need to be resorted to.

For the moment, all of that applies only to the Photoelectric Effect. The next step we must take at our branching off from the historical path of physics is testing our model assumptions at the scattering of high frequency light (X-rays) on electrons.

3.5. The Compton Effect

At the scattering of X-rays on electrons, two effects are observed, which also do not seem to be in accordance with the assumption that light is only a wave.

1. The wave-length of the scattered radiation is greater than the wave-length of the incoming radiation.
2. The scattering angle distribution is asymmetrical with respect to the forward and backward direction.

In 1922, Arthur Compton described the scattering of X-rays on graphite as impact process of light-particles and electrons.

He derived the measured, on the scattering angle ϑ dependent difference between the wavelength λ_2 of the scattered and the wavelength λ_1 of the incoming radiation

$$\lambda_2 - \lambda_1 = \lambda_C (1 - \cos \theta) \quad (\lambda_C \text{ Compton wave-length of the electron})$$

under the assumption that light particles are scattered on electron particles.

The difference between the Compton Effect and the Photoelectric Effect, seen from the conventional viewpoint, is that at PE the photon is absorbed, i.e. its total energy is passed to the electron, whereas at CE the photon is deflected and loses only a part of its energy.

From our viewpoint, the difference between the two effects consists in the fact that at PE both waves form a persistent superposition, whereas at CE they separate again.

Therefore, seen in this way, the scattering process photon-electron proceeds in two steps:

A: The photon hits a resting electron. Both waves form a superposition.

B: The two waves separate again.

In the following outline, to the left the scattering seen as particle impact, to the right our two-step variant:

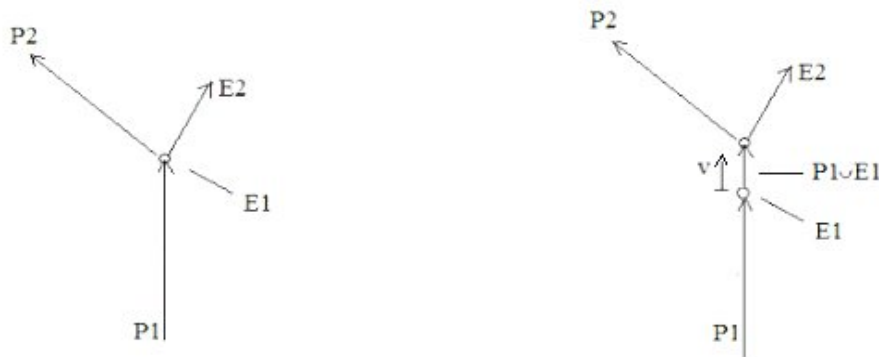

(S3)

$P1 \cup E1$ denotes the short-time state where both waves are united.

Thus the whole process can be described as follows:

The resting electron $E1$ unites with the photon $P1$. Hence it turns into E_+ . ($E_+ = P1 \cup E1$). E_+ moves with velocity v . E_+ emits the photon $P2$ and turns into the electron $E2$.

Let us denote the laboratory system as the reference frame S . Now let us look at the scattering process from a reference frame S' , which moves with velocity v relative to S , and with respect to which E_+ is at rest. (Thus $E1'$ moves with $-v$ relative to S' .)

An electron moving at v possesses a de Broglie wave-length

$$\lambda_B = \lambda_C \frac{c}{v} k \quad \left(\lambda_C \dots \text{Compton wave-length of the electron, } k = \sqrt{1 - \frac{v^2}{c^2}} \right)$$

Therefore with respect to S' applies:

(1) The wave-length of $E1'$ is $\lambda_C \frac{c}{v} k$.

We remain in S' . We look at first at the case where both waves separate exactly along the straight line on which $P1'$ was moving towards $E1'$:

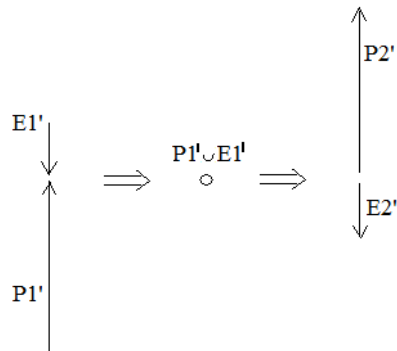

(S4)

Obviously, in this case, the separation process $SP(0^\circ)$ represents the inverse of the uniting process UP , and this leads to

$$P2' = P1' \quad \text{und} \quad E2' = E1'.$$

Thus E_2' moves with velocity $-v$ with respect to S' . (exactly as E_1' before); in the usual description, P_2' would be just an *unscattered* photon.

Now we turn to an arbitrary separation direction ϑ . With respect to S' , after the separation P_2' and E_2' again move away from each other along a straight:

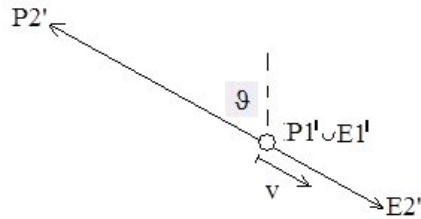

(S5)

Compared with the separation process $SP(0^\circ)$, the separation process $SP(\vartheta)$ is only *rotated*, but unchanged in any other respect. Thus it is the *same* process, and the absolute value of the velocity of E_2' in S' is therefore again $|v|$, and the Photon originating from $SP(\vartheta)$ is – except for the direction – identical with the one that originates from $SP(0^\circ)$.

Combined with what has been said just before, it follows:

(2) With respect to S' holds: Except for the direction, the light waves P_1' and P_2' are identical.

Thus $\lambda_{P_1'} = \lambda_{P_2'}$ for all scattering angles ϑ .

At last we need the following:

In S' , E_1' moves with velocity $-v$. E_+ is at rest.

Now the question is: E_+ is the superposition state of the two waves P_1' and E_1' . If E_+ is at rest, what follows with respect to P_1' ?

The de Broglie wave-length of the electron: $\lambda_B = \lambda_C \frac{c}{v}$ k is a relativistic phenomenon: Due to the Lorentz transformation of an in-phase oscillation to a system moving with velocity v , the phase

coincidence is canceled and a phase-wave with just this wave-length emerges. If the movement generated in this way should disappear, then this phase-shift must be annulled.

Let us look at the short-time superposition E_+ of the waves representing $P1'$ and $E1'$:

According to (1), $E1'$ is represented by (f_e ... frequency of the resting electron)

$$\cos 2\pi \left(t f_e \frac{1}{k} + x \frac{1}{\lambda_C} \frac{v}{c} \frac{1}{k} \right) = \cos 2\pi \left(t f_e \frac{1}{k} + x \frac{1}{\lambda_B} \right)$$

$P1'$ is represented by

$$\cos 2\pi \left(t f_{P1'} - x \frac{1}{\lambda_{P1'}} \right)$$

If we now set the wave-length of $P1'$ equal to the one of $E1'$:

$$\lambda_{P1'} = \lambda_B = \lambda_C \frac{c}{v} k$$

then, according to the identity

$$2 \cos a \cos b = \cos(a + b) + \cos(a - b)$$

we obtain, as the result of $E1' * P1'$, *two waves* (in the same way as at the Photoelectric Effect):

In the first wave, the x -term disappears, which means that the phase shift is in fact canceled and that, therefore, the velocity of E_+ is indeed equal to 0.

The second wave would move, seen from S , opposed to the direction of the incoming photon, but at the same time its frequency would be reduced compared to the frequency of the electron $E1$ that rests in S , which would be impossible. As in the Photo Effect, also here this second possibility is inapplicable.

Thus we can state:

(3) With respect to the reference frame S', the incoming photon P1' possesses the wave-length

$$\lambda_{P1'} = \lambda_B = \lambda_C \frac{c}{v} k$$

Now we must just transform from S' back to the laboratory system S.

In order to calculate the wave-lengths of P1 and P2, we need the relativistic Doppler Effect with respect to an arbitrary angle ϑ , which has the following form:

$$\lambda' = \lambda \left(1 - \frac{v}{c} \cos \vartheta\right) \frac{1}{k}$$

In our case is
$$\lambda_{P1} = \lambda_{P1'} \left(1 - \frac{v}{c}\right) \frac{1}{k}$$

and, because of (2)
$$\lambda_{P2} = \lambda_{P1'} \left(1 - \frac{v}{c} \cos \vartheta\right) \frac{1}{k}$$

From this follows
$$\lambda_{P2} - \lambda_{P1} = \lambda_{P1'} \frac{1}{k} \frac{v}{c} (1 - \cos \vartheta).$$

If we now insert the value of $\lambda_{P1'}$ from (3), we get to

$$\lambda_{P2} - \lambda_{P1} = \lambda_C (1 - \cos \vartheta)$$

and this is the desired result.

What about the asymmetry of the distribution of the scattering angles?

In S', all scattering angles are equiprobable, which means: equally distributed between 0 and 2π . For the laboratory system S follows then the observed, with the frequency of the incoming photons increasing asymmetry of the distribution of the scattering angles.

Thus also in the description of the scattering of high frequency light on electrons it was possible, without any physical resources and prerequisites, only based on the assumption that both light and electron are waves, to derive the correct result. Since this result is given here in the form of a wave-

length difference, it was – other than at the Photo Effect – never necessary to change over to the usual "mechanical" description. We did not even need to mention the concepts energy and mass.

As could be seen, symmetry assumptions were applied. However they did not serve, as usual, for substantiating conservation laws, but for the assumption that, with respect to S', only the propagation direction of the two waves changes after they have separated, whereas in every other respect they remain identical.

Everything which was said at the end of the previous section, applies identically or analogously also here. Therefore, a summary or a commentary is superfluous.

Thus we have described the two experiments, by which the wave-particle dualism was brought into physics, solely by wave superpositions. The assumption of light particles could be dispensed with.

The next step will be to eliminate the dualism of matter. This purpose seems to be precluded by the fact that this dualism represents downright the basis of the quantum mechanical formalism and its interpretation.

3.6. The Reduction of the Wave Function: what actually happens

"Unter den [...] Gegnern der 'orthodoxen' Quantentheorie nimmt Schrödinger insofern eine gewisse Ausnahmestellung ein, als er nicht den Teilchen, sondern den Wellen die "objektive Realität" zusprechen will und nicht bereit ist, die Wellen nur als Wahrscheinlichkeitswellen zu interpretieren. [...] Freilich kann Schrödinger [...] nicht das Element von Diskontinuität aus der Welt schaffen, das sich in der Atomphysik überall [...] äußert. In der üblichen Deutung der Quantentheorie ist es an der Stelle enthalten, wo jeweils der Übergang vom Möglichen zum Faktischen vollzogen wird. Schrödinger selbst macht keinen Gegenvorschlag, wie er sich etwa die Einführung des überall zu beobachtenden Elements von Diskontinuität anders als in der üblichen Deutung vorstellen will."⁴¹

("Among the objectors of 'orthodox' quantum theory, Schrödinger takes insofar a certain special position, as he wants to assign not to the particles but to the waves the 'objective reality' and is not willing to interpret the waves just as probability waves. However, Schrödinger is not able to eliminate the element of discontinuity that appears everywhere in atomic physics. In the usual interpretation of quantum theory, it is incorporated at that position where the respective transition from possibility to reality occurs. Schrödinger himself presents no counter-proposal how he would imagine the

⁴¹Werner Heisenberg, Phys. Bl. 12 (1956), S. 300.

introduction of the everywhere observable element of discontinuity other than in the usual interpretation.")

In 1926, Schrödinger found his "wave function". It was his intention to relate it to anything "real". For this purpose, he considered it necessary to construct wave packets that do not disperse but maintain their spatial extent. In other words: he aimed at modeling *particles*. However after it had become apparent that, with the exception of the harmonic oscillator, the wave packets disperse at *all* quantum mechanical systems, he abandoned this project.

The essential question is:

Is the possibility to construct wave packets that do not disperse in fact a necessary condition for assigning an element of reality to the wave function?

The answer is *no* – but substantiating this answer requires a radical adjustment of our conception of the (atomic) reality. The following explications are meant as introduction to this adjustment. At first a model will be presented, afterwards the model assumptions will be generalized, and at last – in section 3.9 – some possible counter-arguments will be discussed.

What Heisenberg meant by the discontinuity that occurs at the transition from possibility to reality is of course the *reduction of the wave function*. It can be illustrated using the double slit experiment:

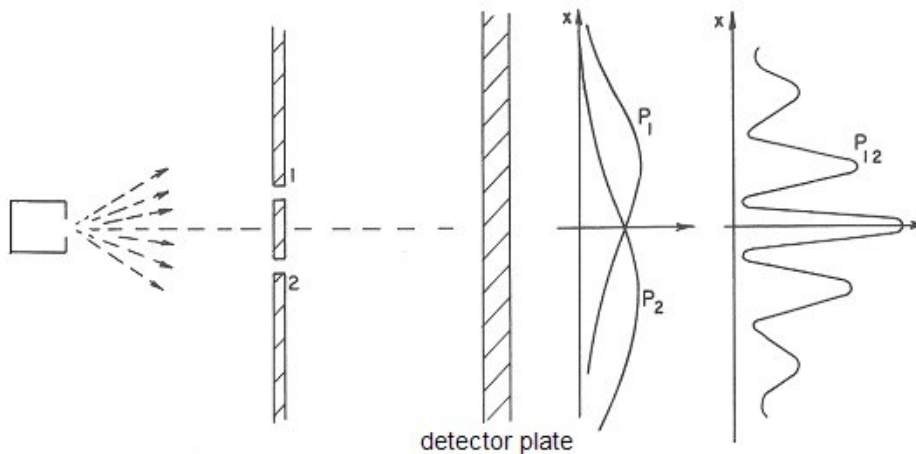

(S2)

This time we focus on the following point

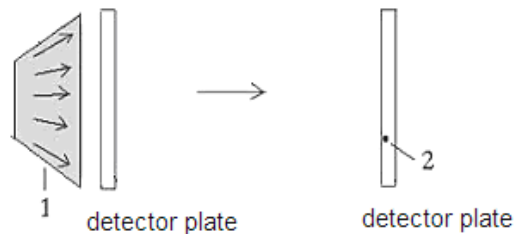

(S6)

To the left, labeled as **1**, the state of the particle – say: of an electron – at the moment of its impact on the detector plate: *an extended wave* that has emerged from diffraction at the double slit and subsequent interference.

To the right, labeled as **2**, the observable consequence of the state of the same particle at the next moment: *a black point*.

So now we are standing before the innermost secret of quantum mechanics, i.e. the question:

Why disappears the extended wave and turns into a particle? Or, with Heisenberg's phrasing: How turns possibility into reality?

What is the reduction of the wave function?

The No-Nonsense Hypothesis, which we established just before the description of the Photoelectric Effect, leaves again only one possibility of interpreting the *real* proceedings.

Initially, I shall repeat my argument concerning the so-called wave-particle dualism.

There is nothing which can be wave *and* particle. Therefore, if objects exhibit attributes of both, then the two concepts must be in a dependency-relationship with each other, i.e. one of the two concepts must be *derived* from the other one, and the notions connected with it must be understood as *defined* by the notions connected with the other one.

However the problem is not symmetrical. A wave is defined as a dynamic shape. All wave attributes, as e.g. diffraction and interference, are inseparably associated with this definition. They cannot be

reduced to anything different. So if the concept *wave* is replaced by anything different, the attributes connected with it get lost.

In contrast, a particle *as such* is not at all defined – it obtains its definition only by the attributes assigned to it. Thus it appears just as the carrier of these attributes, with which it is – other than a wave – associated only *by definition* and not logically.

Therefore, the concept wave cannot be substituted by a different one, but the concept particle can be substituted without loss, if the attributes are retained at this substitution (e.g. localization, discreteness).

If one looks at the double-slit experiment under these conditions, then one realizes almost immediately that the wave concept provides indeed an explanation for everything observed. As is well known, *all kinds* of waves appear in two shapes: as propagating waves that exhibit diffraction and interference, and as standing waves that are spatially limited by boundary conditions and can only exist in certain discrete states. Exactly those two shapes appear at the double slit experiment, and also the transition between them is basically a matter of course.

However as the general thinking is frozen here in an outright magic torpor for already more than a hundred years, it seems appropriate to explain the whole procedure explicitly. This shall now be carried out.

After what has just been said, the electron *is* a wave. Therefore, it does exactly what waves do: it propagates through *both* slits, is diffracted by them so that it disperses, and interferes after the double slit (as is the case also in Schrödinger's description).

Then the electron-wave hits the detector plate. But this plate is also a wave, or, to say it more precisely: a wave-field. Thus the penetration of the electron-wave into the wave-field "detector plate" will lead to wave superpositions.

As regards their spatial limitation, the atomic electron shells correspond to simple standing waves, where it is determined by boundary conditions in which stationary states they can oscillate, in other words: at which oscillation states they are stable.

What happens to a standing wave, if the excitation conditions are continuously altered?

Let us look at a standing air-wave in a pipe. At first, the continuous alteration of the excitation conditions effectuates nothing observable (hearable) – we hear a constant tone; however if the alteration exceeds a certain limit, the standing wave *jumps* into the *next stable state*: we hear the

adjacent overtone. If we counted the waves in the tube, we would see that *after* the jump there is an additional vibration node in the tube (or one less). However it is evident that not just a single oscillation-area has been added but that the standing wave *as a whole* has reorganized itself according to the boundary conditions.

Therefore, also in the case of a *continuous alteration* of the excitation conditions, what can be observed (heard) is a *discrete sequence* of tones, corresponding to the possible stable states of the standing wave, that is: the jump of the whole wave into a state with a partial-wave more (or less), whereas the *actual, causative* process is *continuous*.

Thus we expect similar circumstances also in the case of atoms and molecules. Accordingly, electron shells can only exist in certain discrete states, i.e. are only stable in such states. If the state of the *entire shell* – which means: of the whole oscillation of the respective space area – changes *continuously*, nothing observable happens until the alteration has reached the point where the (ostensibly) discontinuous jump into the next stable state is necessitated.

In the same way as at the standing wave in the tube, also here we observe the *discrete sequence* of possible stable states of the whole spatial oscillation area. The jump between the stable states manifests itself *locally*, as appearance of an additional node plane and, with it, an additional oscillating area. But also here, it has of course not just been added *as an individual one* (as it would be the case with the particle concept) but appears as the consequence of the reorganization of the whole spatial wave structure. And also here applies: the actual process is continuous.

Back to the double slit experiment. Almost everything needed has already been said. Now, additionally, only the following must be assumed:

That, which just before, in the case of standing air waves, was called "continuous alteration of the excitation conditions", is in the case of electron-waves the *continuous accumulation of wave intensities*.

Thus this assumption reads as follows:

The discontinuous alteration of the local oscillation state, which presents itself as measurement result, is caused by a continuous process: by waves, the amplitude squares of which add up until a transition occurs.⁴² Thus the probability of such a transition is determined by the local wave-intensity.

⁴² It was exactly this assumption, applied to photons, which has made the local description of entangled photons possible.

So everything is indeed very simple: waves hit the plate, penetrate into it and form superpositions with the waves of the plate. The wave intensities, the distribution of which corresponds to the quantum mechanical probability density (the curve in (S2)) add up at the respective position of the penetration, until the spatial oscillation state (the electron shell) located at this position "jumps" into the next stable state, in the usual view: "an additional electron appears". Therefore, these transitions are the consequences of local conditions, independent of other simultaneously adding-up processes of the same kind, which *later* will also lead to transitions.

In particular, at the time of a transition, *no disappearance of other waves occurs*.

Under these conditions, formally there is no difference to the usual view – only the interpretation of the amplitude square changes: instead of a probability density, which refers to *nothing existing* and represents a purely formal tool, there is now a probability density, which owes its existence to a *physical quantity*: the intensity of a real wave. The result is in both cases identical.

To achieve complete congruence with the quantum mechanical specifications, our model needs only an element of chance. However this is in fact already there, because it cannot be presupposed that, before the arrival of the electron-waves, all electron shells are in *exactly* the same states.

To illustrate that, we look again at the analogue circumstances in the case of standing air waves. Imagine a great number of identical tubes, in which the air oscillates at the third harmonic. From this does not follow that the states of the air columns are identical in all pipes. In some cases, the slightest change of the excitation conditions could trigger a jump into the second harmonic, in some other cases a jump into the fourth harmonic, while some others are insensitive to small alterations.

Analogously, we have to assume that, within the whole range where the oscillation states do not change abruptly, the electron shells are randomly distributed.

With this, all quantum mechanical facts and predictions regarding the double slit experiment are explained by continuous, local and objective processes.

In this simple local and objective model, there are no secrets. All absurdities have dwindled away: there is no *reduction of the wave function* – at least not in the sense that anything vanishes, the assumption of *objective probabilities* is superfluous, nothing has to be *wave and particle*, the *measurement act* has no special relevance, no *observer-awareness* intrudes, the *universe does not split* into infinite nearly identical copies of itself, and so on and so forth ...

We can see very clearly how and where we have been deceived: There are no particles. Electrons, as well as all other elementary particles, are by no means "indivisible units". We succumb to this illusion only because *they appear as such in all observations*. ("Events" are always transitions!)

Actually, they are continuous, dispersing waves or wave-packets, which only under certain conditions that are met within matter occur *localized* and in an always identical form.

The reduction of the wave function – the disappearance of an arbitrarily extended wave phenomenon and ostensibly discontinuous occurrence of a localized event – does not take place. In the wave model, it turns into a normal physical process.

So from wave-particle dualism we have come to wave monism. However, this is not a loss – what was previously referred to as "particle" actually remains *the same phenomenon*: localized, discreet and always formally identical. Only the definition has changed: objects, which originally were designed according to the idea of macroscopic things but failed to fit into this model already from the beginning and were therefore basically undefined, are now seen as stationary wave states or transitions between such states.

Thus, in actual fact it turns out: the inability to abandon mechanistic ideas (particles, impacts etc.), which endures already more than a hundred years, has led the interpretation of physical theories onto a wrong path and has forced physicists to move along this path ever further.

Notes

1. The explanation of the double slit experiment is so simple that one can hardly believe that up to now it has not existed. Why is it that it could remain undetected for so long? The cause is the following suggestive idea:

Suppose a person A throws a ball to a person B. Then, of course, there cannot be the slightest doubt that the ball, which B catches, is *the same* ball, which A has thrown. This fact is so obvious that it does not even appear mentally: no one would ever think to ask whether it is the same ball – this question would be simply absurd.

Precisely this concept, however, – including the just mentioned unquestioned obviousness of the identity of the thrown and the caught ball – has been transferred to the double slit experiment. The reason for this complete transfer is the *particle idea*: If the electron is regarded as *particle*, then the conditions at the double slit experiment appear analogous to those at the ball throwing.

However the electron *is not* a particle but a wave or a transition between two wave states, and the transition called "electron", which appears on the detector plate, *is not* identical with the wave called "electron", which directly before has passed through the double slit and then reached the detector plate. This transition, i.e. the observed event, contains indeed not only parts of *this* wave, but also of waves that have arrived *earlier*, and also of waves that have been there already before the start of the experiment (with the consequence that many oscillation states have already been close to the border above which a transition occurs, before the experiment began).

In other words: **The electron, which is now detected, is not identical with the electron which has been generated immediately before** – or, to put it more precisely, it is not *substantially* but only *formally* identical with it.

In the ball-throwing analogy, this would mean: *The caught ball is not identical with the thrown ball, it just looks the same.*

As long as one remains bound to this analogy, it is obviously impossible to understand the double slit experiment, and the same is true for all other quantum-mechanical measurements.

2. In the standard interpretation of the double slit experiment, there are no continuous processes inside the detector plate but only discontinuous transitions. But in the new interpretation, these transitions are caused by continuous processes. What processes are these? Exactly those which *always* occur with waves: if the frequencies of the incoming waves and of those already present are identical, then the amplitudes add up, if they are different, then combination frequencies evolve.

It is possible to define the energy proportional to the amplitude square. Then also to the states, which lie between the stationary states, a definite energy can be assigned. (In principle, this proportionality exists also in the standard interpretation. Think e.g. of the Photo Effect: although here the energy of the emitted electrons is independent of the light amplitude, still the number of the detected electrons depends on it.)

3. I presented the simplest version of the model. Various additions are necessary. At least one of them appears important enough to deserve a short note:

It is determined by boundary conditions which oscillation states are stable. These states must be understood as *attractors*. (This applies to standing wave states in general.) This means that a local oscillation state will approach the attractor if the point of the state space by which it is represented lies within the basin of attraction.

Let us assume, a local wave system (an electron shell) is exactly in an attractor state. If now waves from outside penetrate and add to the ones that are already there, then the system is in a certain distance from the attractor. It will then try to approach the attractor again, i.e. it will try to emit waves. Where? To the adjacent wave systems. Thus *exchange processes* will take place, to which the following simple rule applies: The nearer the state of a local wave system to the attractor, the stronger its tendency to approach the attractor. This means: in the case of two spatial oscillation states adjacent to each other, the one whose state is at a smaller distance from the attractor will pass the surplus waves to the other one. However if the state of a system is pushed above the border between the basins of attraction of the actual and the next higher attractor, then this system will try to approach this next attractor, i.e. it will absorb waves from the surrounding systems.

Regarding our basic thought trains, nothing is changed by this additional hypothesis. However the dynamics of the proceedings is modified.

As an example, we look at the distribution P_1 of the outline (S2). For the moment we ignore all random fluctuations and assume that all systems are exactly in attractor states.

Let us now look at two adjacent systems (local oscillation states, electron shells), which are located at an arbitrary position on the surface of the detector plate. In the one system, which is farther from the maximum of the curve P_1 , the amplitude square of the penetrating waves (according to the curve P_1) will be smaller than in the other one. Thus this system remains nearer to the attractor state, and therefore it will pass the surplus waves to the other system. This process takes place simultaneously at all pairs of adjacent systems. Therefore, all waves will eventually land at the system that lies exactly at the position where P_1 has its maximum. In this system, all amplitude squares of the waves that have penetrated into the plate will be added up and cause a transition.

However this would only be the case if there were no random fluctuations at all, and therefore it can never happen in this form. Yet this idealized example shows that the waves, which penetrate into the plate, can trigger a transition not only at the point where they hit the plate, but that they can also be transported through exchange processes into some distance and contribute to transitions there.

In some cases, the attractor concept and the associated hypothesis of exchange processes are possibly needed for the explanation of the sequence of events – e.g. in the Photo Effect in order to understand why never several electrons are detected simultaneously.

4. What has been said about the *detection* of electrons on the surface of the detector plate, applies analogously to the process of their *generation*:

Thus if on the left side of the outline (S2) electrons are generated, this does not mean that one particle after the other disengages. Instead it is a *continuous* process.⁴³ A continuous radiation of waves takes place, until somewhere a transition occurs – a local oscillation state, i.e. one electron shell *as a whole*, changes into a different state that has one node plane less. This changeover appears again *discontinuous*. In the usual view: an electron is generated. (Also here, it would be possible to assume exchange processes as described in point 3.) The wave packets which are now underway do not originate from one single transition, in other words: they do not correspond to one electron. Instead they contain waves from many such transitions that are defined as electrons.

5. What has been said about electrons applies also to photons.

3.7. *The Reduction of the Wave Function: Generalization*

In order to generalize our model assumptions, we have to make a short excursion into the formal part of quantum theory.

Let $\Psi(x)$ be the state vector of an object T. An attribute of T is to be measured that corresponds to the operator A.

Let be $A\Psi(x) = \sum_{i=1}^n s_i U_i(x)$ (U_i eigenfunctions, s_i coefficients)

Let a_i be eigenvalues of the corresponding U_i . Then the result of the measurement will be one of the a_i .

So much to the quantum mechanical specifications, the validity of which is verified to such an extent that they can be considered facts. But now the area of interpretation begins:

If the value a_j ($1 \leq j \leq n$) is measured, then T – i.e. *the very object* that has been represented before by

$\sum_{i=1}^n s_i U_i(x)$ – is supposed to be in the state U_j : the whole sum $\sum_{i=1}^n s_i U_i(x)$ has been reduced to the one term $s_j U_j$.

⁴³ Exactly as in the Photoelectric Effect (Section 3.4).

Let us call this hypothesis (H1). It is the fundament of the contemporary interpretation of quantum mechanics:

(H1) *The state function after the measurement, which is reduced to one single term, represents **the same object** as the state function before the measurement. The one term corresponds to the state of this object after the reduction.*



A simple illustration:

(S7)

T is the object, on which the attribute A is to be measured. T1, T2, T3 and T4 represent 4 different possible states of T after the measurement. If $j = 3$, then T3 becomes the measured reality. T1, T2 and T4 disappear.

Thus hypothesis (H1) says: **T3 is the same object as T**. T is the state of the object *before* the measurement, T3 is the state of the object *after* the measurement.

In contrast, the model presented here is based on the following hypothesis (H2):

(H2) *The object that after the measurement is in the state U_j is **not the same object** as the one which was represented by $\Psi(x)$ before the measurement. None of the eigenfunctions U_i with $i \neq j$ that belong to the representation of the object T disappears; instead they will all contribute to subsequent measurements, where other, with T formally identical objects (e.g. electrons) will be measured. Thus there is no "reduction", at least not in the sense that anything disappears.*

(H2) means:

1. *A part* of T – the one, to which T has been "reduced" according to (H1) – contributes to the *actual* measurement result, i.e. to the value of the attribute A, *all other parts* of T contribute to *other, future* measurement results.

2. In general, the measurement result is caused not only by waves of T but also by waves that stem from other objects which are formally identical with T.

Thus in the scheme depicted in (S7) applies – in contrast to the usual interpretation:

T3 is *not* the same object as T. On the one hand, T3 contains not only waves of T, and, on the other hand, T contains also waves which do not contribute to the event T3, but to (possible) future events T1, T2 and T4.

This can be illustrated by the following example:

Let T be an electron. The momentum of T is first to be calculated and then to be measured.

To determine the probability distribution of the measurement values, the momentum operator must be applied to the wave function Ψ which represents T. This procedure is a *spectral analysis*: Ψ is split into sine waves with different wave-lengths, and the according amplitudes are determined. Their squares give the desired probabilities.

In the experiment, the wave-packet must *actually* be split. This splitting could be carried out e.g. by the following arrangement:

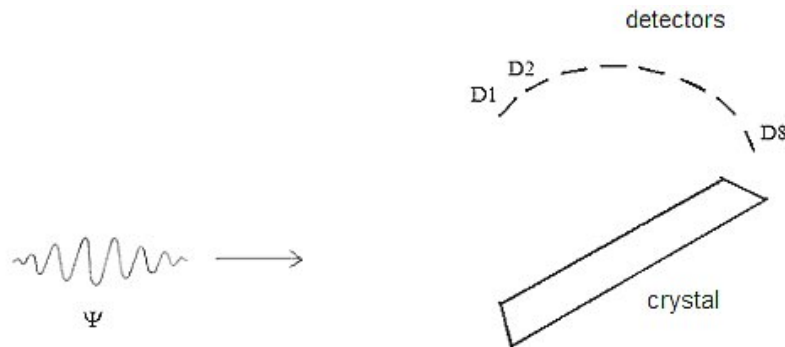

(S8)

The wave packet Ψ is dispersed at a crystal, which means that the waves with different wave lengths contained in Ψ are diffracted at the crystal surface. This surface acts as a plain diffraction grid which decomposes the wave packet into virtually monochromatic radiation bundles. Near the crystal surface all waves interfere, yet at a sufficient distance the rays separate, such that all waves that arrive at a certain detector have a (nearly) identical wave length. So we have sorted the wave packet by wave-lengths (momentums).

Thus the *formal* division by the application of the momentum operator corresponds to the *real* division of the wave packet into sine waves with different wave-lengths by the experimental setup.

According to the usual interpretation, the measurement has the effect that one of the eigenfunctions of the momentum operator leads to the measurement result, that is: it becomes *real*, whereas the others *disappear*. In one detector we now have an electron with a certain momentum – which did *not* exist before –, in the other detectors we have *nothing*.

In the interpretation proposed here, there is no reduction. None of the eigenfunctions disappears. All eigenfunctions will contribute to future events (measurements). The amplitude squares of waves with a certain wave-length add up in the respective detector, until a transition occurs – a momentum measurement has been carried out (which in general is again not the consequence of a single wave-packet but requires the adding-up of amplitude squares of many wave packets that had arrived earlier).

Also here it can be seen clearly that quantitatively nothing changes. The wave packets are divided into sine waves with different wave-lengths, which arrive at the corresponding detectors. If now, according to our basic assumption, the characteristic re-organization of a local spatial oscillation state – i.e. the appearance of an electron – is *caused* by the adding up of wave intensities, then the probability of the events in a certain detector must depend on the amplitude square of the waves that *actually* hit this detector – exactly as predicted by quantum mechanics.

Doesn't it somehow contradict the QT formalism to assume that a particle develops somewhere and later *the same* particle appears again – even if formally (*and* experimentally) a partition takes place and the parts are displaced arbitrarily far from each other? It would not be totally absurd to call this an interpretation *against the formalism*.

At that, only under these preconditions paradoxes appear, e.g. if we ask "which way" the "particle" takes at the double-slit experiment.

In contrast, my proposal keeps close to the quantum mechanical formalism and permits connecting the concepts of the formalism with a local reality:

If a particle X is generated at a certain position *before* the measurement, and *after* the measurement an identical particle appears at another position, then this is not *the same* particle; the waves originating from the decomposition of the characteristic oscillation pattern X split up according to their formal description – they *actually* diverge – and contribute to the development of another oscillation pattern X, which however deserves to carry the same identifier X not because it is *substantially* but *formally* identical with the first one.

3.8. The central Assumption of the local and objective Interpretation

The objective and local interpretation of quantum mechanics is based on one single assumption. Everything else can be reduced to it. It reads as follows:

*If event probabilities can be determined by a quantum mechanical wave function, then there is an **actually existing wave** which causes these events.*

Accordingly, quantum mechanical amplitude squares are not just formal tools: they represent probabilities only because they correspond to intensities of real waves.⁴⁴

From this follows directly that there is ***no reduction of the wave function***: what exists, cannot disappear.

It follows also that ***there are no particles***: since wave functions, which represent particles moving outside of matter, diverge in general, a realistic interpretation forces the abandonment of the particle concept in its usual form. It is replaced by another particle concept which is defined in the following way:

⁴⁴ What about the probability amplitudes of events that will *not* occur? (E.g. the state of a radioactive nucleus is a superposition of the states *decomposed* and *not decomposed*.)

The answer is: If amplitude squares are defined as probabilities, then the introduction of amplitude squares is necessitated, which represent the complementary probabilities. It is this formal act of completion to which those – in this sense – "complementary" amplitudes owe their existence. Still, it can be stated that they relate to real waves, however only via this formal intermediate step.

Particles are stationary states of waves or transitions between such states, caused by waves.

Therefore, dualism and complementarity appear only in the area of the phenomena. The fundamental, causative layer of reality is wave-like.

3.9. Objections

In this section some objections shall be discussed which could be brought forward against the realistic interpretation of the wave function (and which have actually been alleged in the historical discussion), and also some objections against the hypotheses derived from it.

1st objection

The description takes place in the multidimensional configuration space. Therefore the elements of the description cannot be real.

This is a strange argument, not to say: not at all an argument. It is never the case – not at any mathematical description of an area of reality – that the representation is simply identical with the real scenario. In some cases, this assumption would be outright ridiculous. As mentioned before, the temporal development of a fish population in a pond can be represented by the logistic equation. But the logistic equation *is not* a fish population, and fish *are not* real numbers. Nonetheless nobody would consider this fact as a reason to doubt the real existence of fish.

Thus the realistic interpretation of a mathematical formalism does not mean *identifying* elements of the description with elements of reality, but assuming that there is a *connection* between elements of the formalism and elements of reality.

Therefore, in the case of a realistic interpretation of quantum mechanics, it is not necessary to assume that the waves which appear in the quantum mechanical formalism *are* real waves. The following weaker assertion is sufficient:

The state vector Ψ is *not only* a mathematical tool. For any Ψ there is an actually existing wave with which Ψ is connected in the following way: Every possible event, the probability of which can be determined using Ψ , is caused by the real wave connected with Ψ .

2nd Objection

There is no physical concept with which the amplitude of the Schrödinger equation can be associated.

This assertion is correct. *What* actually oscillates in this equation cannot be answered within contemporary physics.

Accordingly, this objection is not directed against the realistic interpretation of the Schrödinger equation but points only to the fact that, in order to determine *what* the subject of the equation is, one must leave the area of usual physical concept formation.

However this is a matter of course, because it must be assumed that Schrödinger's wave-function describes in fact the *fundamental layer* of reality, and therefore the question is involved, how *existence* is to be defined in physics.

With this it is clear that that, which the amplitude of the Schrödinger equation relates to, cannot simply be identified with any known element of physical modeling.

3rd Objection

There are quantum mechanical quantities, which cannot be interpreted as attributes of actually existing objects

An example of such a quantity is the *spin*, which could indeed be called the "most quantum mechanical" of all physical attributes.

A part of the argument, by which this objection can be invalidated, is already contained in the scheme which has served for the local and objective interpretation of quantum mechanical scenarios. I cite from section 1.4, where the local reconstruction of quantum mechanical predictions on entangled photons has been presented:

"The measuring result must not correspond to the attribute of an object. Instead only the accumulation of objects should trigger an event."

And further below:

"What does it mean, in this model, that *a photon with a certain polarization direction* is measured? It has the following meaning: waves that have passed through a polarizer adjusted at this angle cause a transition. To this transition – i.e. the "photon" – can then be assigned the attribute *polarization at this direction*. Only in this sense we can speak of the attribute *polarization of a photon*."

Therefore it can be asserted:

Paradoxes appear only because measurement results are interpreted as *object attributes*. It is impossible to interpret the spin as attribute of an actually existing object "photon".

In the case of photons, this explanation is sufficient, as photons are just *transitions* between localized, stationary oscillation states and *not* objects.

However electrons are not just transitions between oscillation states but these oscillation states themselves, and the problem is, that also if they are interpreted in *that* way, apparently they cannot be understood as real objects. It seems as if it were impossible to interpret their spin realistically, even if they are seen as oscillation states instead of "particles".

This problem will be cleared up in the Second Part. Here I will only shortly comment on the question: *What means "real"?*

Current physics has developed from experiences on existing objects. Its concepts and abstractions originate from the realm of the existing. Within the limits of this conceptuality, it is indeed impossible to understand the spin realistically: it is not a thinkable attribute – neither of a particle-like object nor of an oscillation state.

In the Second Part, physics will be built up from the *other side*, which means: not from the realm of the *concrete* but from the realm of the *most abstract*. Here, it is necessary at first to reconstruct that which exists. Along this path, which begins at the *origin of everything* and extends to the elementary objects, the spin appears as a simple geometric concept. Thus, if one starts from the abstract foundations of existence, it proves a necessary element of the reconstruction of the world of things,

Representational or objective means: existing as object in space and time.

But *real* is a much more abstract concept:

Let us assume we succeeded in reducing that which exists to something elementary, the necessity of which can be realized, and, moreover, we were able – starting from this elementary and proceeding

with steps, the necessity of which can also be realized – to arrive at the realm of the existing, then it can be defined in the following way, what *real* means:

Real is everything which appears on this path.

Therefore *real* means: *Following with necessity from the necessary preconditions of existence.*

Exactly in this way, also the spin is real, and, if it appears on this path, it becomes geometrically understandable.

That which is described by quantum mechanics lies on the border between the pre-objective and the objective realm. Only as seen in this way – by looking at it from both sides – a quantum object can be understood and interpreted realistically.

However it should be mentioned that for solving the paradoxes of the interpretation of quantum mechanics, it is not at all necessary to go into the difficult issue of defining *real* – it is completely sufficient to assert that something which exists – whatever its definition may be – cannot just disappear.

4th Objection

The amplitudes of the wave function are complex numbers. Therefore, they cannot relate to something existing.

Here applies again, what has just been stated at the third objection: only if physics is built up from the abstract conditions of existence it can be explained why complex numbers are needed for constructing objects.

5. Technical Objections

There are some objections against realistic interpretations of the wave function, which relate to "technical problems" that occurred at historical attempts of such interpretations.

An example: Also before quantum mechanics, the atomic spectra could be described with good approximation, if they were understood as partial frequencies of an overall oscillation state that is decomposed by Fourier analysis – but only with the exception of the amplitudes: at the Fourier analysis, they must be definite, but at the experiment they fluctuated.

I chose this example, because it demonstrates that, in some cases, such problems dissolve just by suspending an unnecessary strong condition. If one understands the oscillation states as attractors, as we did in 3.6, then it becomes immediately clear that the Fourier analysis can only contain the amplitudes of oscillation states which lie *exactly* on the attractor. All other states – those which lie in the basins of attraction but not on the attractor itself – *must* have different amplitudes.

In our model, the "continuous alterations of the excitation conditions" relate to waves that arrive and form superpositions with the waves that are already there, and, under this assumption, fluctuations of the amplitudes are a matter of course.

However, as was the case in my previous deliberations, I will restrict myself to actually fundamental arguments and not discuss further technical questions.

6. Other Objections

The hitherto discussed objections were all directed against the realistic interpretation of the wave function. The most important reservations against the hypotheses that follow from it – that there is *no reduction of the wave function* and that *particles are not elementary objects* but wave states – have already been invalidated in the previous sections.

We have shown that the abolition of the reduction of the wave function does not change anything as regards the quantum mechanical predictions for event probabilities. What is usually understood as "reduction" is replaced by a common physical process. Therefore, the absurd assumption of the non-local disappearance of wave-phenomena, which have proven their existence by interference, is no longer necessary.

As reason for the assumption that *particles are elementary objects*, it is usually pointed at the fact that they are *indivisible*, i.e. they appear always as a whole and in identical form.

However this is also true under the condition that particles are stationary wave states or transitions between such states; and moreover, it is even *explained* by this hypothesis. From this definition follows directly that "particles" must *always* appear as indivisible phenomena. How should it be possible to divide a stationary wave state? It can only exist as a whole, and also regarding a transition between two such states it would be nonsensical to speak of a "division".

Again the analogy of standing waves can be helpful: if constant boundary conditions are presupposed, then there is only the discrete sequence of possible frequencies and wave lengths, and there are the

transitions between the elements of this sequence, which appear discontinuous to the observer. Thus, the observable phenomena are in any case discrete, indivisible and indistinguishable.

The second important element of the usual particle concept is spatial limitation. However exactly this limitation is indeed the basic element of stationary wave states: they are *defined* as spatially limited, and they appear only under respective boundary conditions, which are only realized within *fields*. Outside of fields there are no stationary states, and therefore the waves assume again their other shape – they propagate through space and diverge.

3.10. Explanation of Uncertainty; Interpretation of the Formalism

Any object has anytime and anywhere a definite position and a definite velocity – however only if objects are seen as entities that occupy at any time a well-defined spatial volume. This was exactly the idea which physics was based on before the 20th century. Therefore, the fact that it is impossible to determine both position and velocity of very small objects at the same time provoked enormous amazement. At the beginning, this fact was considered a limitation of measurement, but in the course of time it became evident that it is a limitation of nature itself.

The local and objective interpretation of quantum mechanics started with the alternative descriptions of the Photoelectric Effect and the Compton Effect (in sections 3.4 and 3.5). They were carried out without using any physical concepts and relations, only based on the mathematical definition of waves and on the assumption that both partners of the interaction, light and electron, are waves that form a superposition.

With this, it is demonstrated that, in the case of interaction between radiation and matter, the wave concept is fundamental and the particle concept is derivative. This means, that here the equations

$$E = h\nu \quad \text{and} \quad p = h * 1/\lambda$$

do not point to duality or complementarity but must be understood as *defining equations* of energy and momentum.⁴⁵

⁴⁵ In a wave-like world, it is a matter of course that the non-directional quantity *energy* must be defined by frequency and the directional quantity *momentum* by wave-length. In section 2.6 has been demonstrated that constructing motion by wave superpositions leads directly to the de Broglie matter waves, and from this follows the definition of energy and momentum – with the exception of the constant h, which will be substantiated in the Second Part.

To the quantity *momentum* defined in this way, in connection with the quantity *position*, must then apply an "uncertainty relation", simply because, as is well known, in the case of spatially limited wave trains (wave packets) as depicted in the following outline

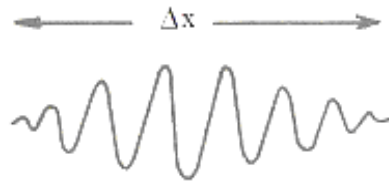

(S9)

always an "uncertainty relation" of the form

$$\Delta x * \Delta(1/\lambda) \geq 1$$

applies. Such wave trains just *do not possess* a definite wave length. Instead, they are composed of waves with different wave-lengths. The smaller the spatial extension is, the greater is the interval of the required wave-lengths. Reversely, the more exact the wave-length – and, in our case, at the same time the velocity – the greater is the uncertainty of the position Δx . If this fact is connected with the equation

$$p = h * 1/\lambda$$

then follows

$$\Delta x * \Delta p \geq h .$$

Of course this has already been said often enough. Nonetheless it had to be mentioned here again, because in the usual interpretation of quantum mechanics, it must be seen as a purely formal fact and not as an explanation. It can only turn into an explanation if it is assumed that particles are stationary wave states and that, accordingly, momentum is *defined* by wave-length.

Thus for the quantities momentum and position, the following applies:

1. Both quantities are *defined* as wave attributes, and they correspond to certain wave categories: momentum is assigned to sine waves, position to pulse waves (i.e. waves, the amplitude of which is only in one point not equal to zero).
2. With respect to both quantities, an uncertainty relation applies. *This uncertainty is a purely wave-mathematical fact.* It is *transferred* to the physical quantities via their definition.

As regards position and momentum, everything that seemed strange from the conventional viewpoint has disappeared. While, in the usual interpretation, it seems outright absurd that a particle should not possess exact values of position and momentum at the same time⁴⁶, in the alternative interpretation – where objects (wave packets) simply *do not have* a definite spatial volume – it is just an evident fact.

The question is if this scheme can be transferred to all physical object attributes.

The answer is *yes*. Strictly speaking, nothing at all has to be transferred – quantum mechanics *is* exactly this scheme. Thus what has to be done is just re-interpreting the formalism.

Let us look at the quantum mechanical scheme in its simplest form:

Quantities to be measured are observables. They are assigned to operators. By applying an operator to the vector in Hilbert space, by which the state of the object to be measured is represented, this vector is decomposed into a series of eigenfunctions, i.e. a *spectral analysis* is carried out: eigenfunctions are waves the form of which depends on the kind of the operator. (E.g. de Broglie matter waves are eigenfunctions of the momentum operator, spherical harmonics – i.e. standing waves on the surface of a sphere – are eigenfunctions of the angular momentum operator.)

Therefore, assigning observables to operators is tantamount to assigning them to *wave-categories*.

However in any set of wave categories, in which a wave superposition can be decomposed, there are pairs of categories to which – in the same way as to sine waves and pulse waves – an *uncertainty relation* applies.⁴⁷ Thus this must also be true at the spectral decomposition of the state vector. And this uncertainty is again transferred to the physical quantities *defined* by these wave categories.

⁴⁶ Just try to think of a car that is neither located at a definite position nor has a definite speed. That's impossible. However the conventional particle concept is just an abstraction of such objects! It carries in it the idea of *material substance*.

⁴⁷ At a division in two such classes of waves, the product of the bandwidths cannot be smaller than 1.

This means: the scheme that applies to position and momentum – which has been described just before – applies to *all* physical attributes (observables). They are defined by wave categories, and the uncertainty relation that applies to so-called canonically conjugate attributes is a purely mathematical fact, which is transferred to the physical attributes by their definition.

So how is this formal scheme to be interpreted?

The most important elements of the interpretation have already been described and explained. Here is a short summary:

The object that emerges as a consequence of the measurement is *not* the same object as the one to be measured; the object to be measured is (in general) a wave group, the partial waves of which will contribute to various measuring events. (See the scheme in 3.7.)

The state vector represents the object to be measured. Thus it relates to the wave packet *before* measurement, and accordingly the spectral analysis relates to the decomposition of this wave packet into waves, which belong to the category which the attribute to be measured is assigned to.

As the wave category in which the state vector is decomposed is freely selectable, the vector contains all measurable attributes *as possibilities* – however not in the Heisenberg sense as another independent kind of (non-)existence but in a completely ordinary sense: each of the waves contained in the wave packet, which belong to any wave category, can contribute to the formation of an object, i.e. of the object of the actual measurement or an object of subsequent measurements.

At the experiment, it is (in most cases) necessary to *actually* decompose the wave packet, as was explained with the example at the end of 3.7. The distribution of the measured values will then, as elucidated in this example, correspond to the distribution of the amplitude squares of the waves contained in the state vector.

The measured object – the carrier of the measured variables – is in any case, provided it is an object of atomic or molecular magnitude, a *newly formed object*, which owes its existence to the measuring process.⁴⁸

⁴⁸ An interesting question is how big and how complex the objects can be, which during the measurement (e.g. at the double slit experiment) are decomposed into partial waves and then formed anew at different positions and times. The limit must be where the *shape-information* – which is contained in the frequencies, wave-lengths and phase-relations of the waves – gets lost, so that the new formation of formally identical objects is no longer possible.

Only due to this *new-formation* of measuring objects, the waves contained in the state vector can become measured attributes, in other words: can possibility become reality.

As can be seen, some of the well-known formulations can be transferred identically into the realistic interpretation – only their meaning changes: statements which are meant to point at the impossibility to conceive what actually happens turn into statements about a comprehensible reality.

Of course it must be in any case explainable *why* an attribute is assigned to a wave category, i.e. what the physical reason for this relation is. In the case of energy and momentum, most of this explanation has already been accomplished. Here is a short recapitulation:

Motion (velocity) of objects has been defined by *superposition of waves*. Thus the existence of uniform motion becomes a matter of course. Change of motion is caused by alteration of frequencies. With this, the conceptual basis for defining energy and momentum already exists, and it can be realized why energy is assigned to frequency and momentum is assigned to sine waves (relativistic phase-shift waves).

Formally, these definitions were demonstrated and verified in the descriptions of the Photoelectric Effect and the Compton Effect.

Why spin and angular momentum are assigned to spherical harmonics (standing waves on the surface of a sphere) will be explained in the Second Part.

With this, the most important relations are explained in a conceivable way. However it must be added that all explanations are only complete if the quantity "mass" can be defined geometrically and if the existence of Planck's constant (e.g. in the equation $E = h\nu$) can be explained in such a way that it is no longer necessary to interpret it as proof for the fundamental discreteness of being (which will also be performed in the Second Part).

In short: quantum theory does not unite the wave- and particle-like attributes of objects of the fundamental layer of reality. Rather it is the theory where the fundamental world of waves and the object-world built from them meet one another. Therefore it is also clear that quantum theory is unavoidable: all physical descriptions – as abstract as they may be – serve ultimately for explaining experiences with objective circumstances.

Thus we can summarize: *Quantum theory is exactly the theory that allows describing the fundament of reality, which consists exclusively of waves, by quantities which originate in – and fit to – the object-world of our everyday experience.*

As has been shown, the current epistemological bewilderment is not rooted in the formalism of quantum mechanics but in its interpretation. It is the inability to abandon thought patterns that originate in the world of things, which produces paradoxes and leads to the loss of any understanding of reality.

At last, let us look at some eigenstates of the hydrogen atom. The following outline shows the amplitude squares of the according wave functions – usually interpreted as "density distribution".

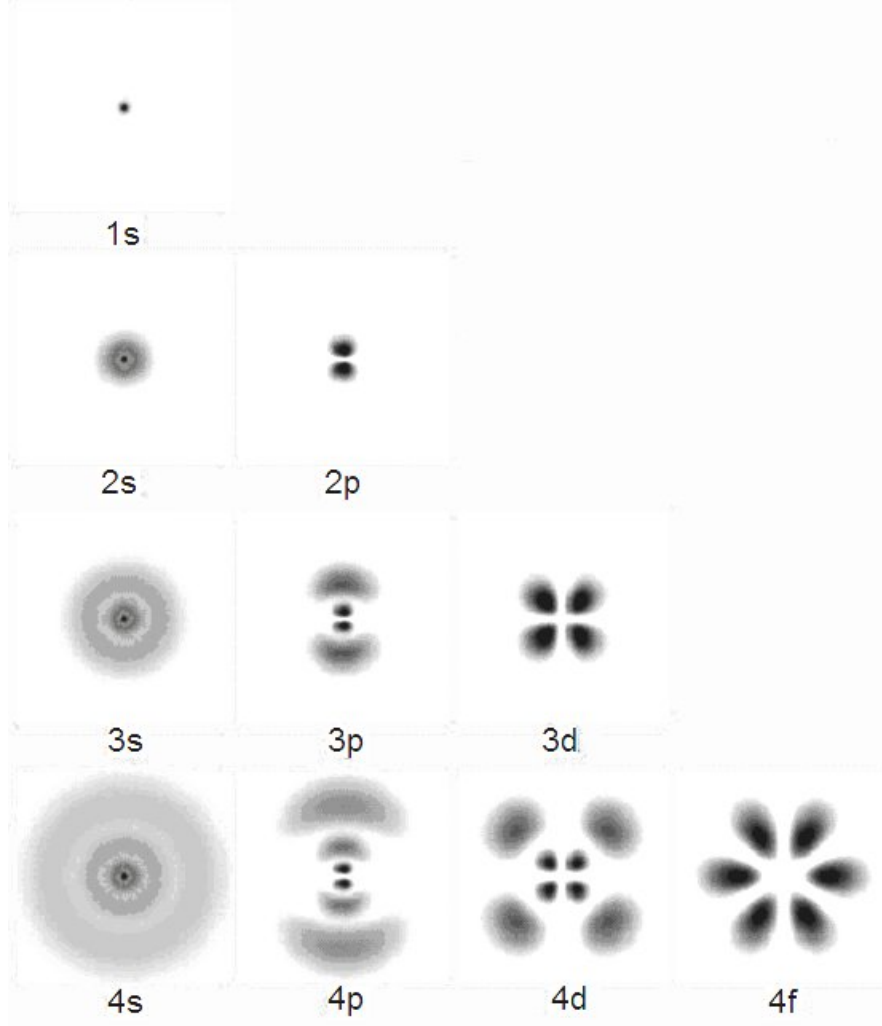

(S10)

Now we can either assume that these wave functions are nothing but mathematical tools for determining the probability of the (point-like?) electron – with all the absurd consequences mentioned above, or we accept what is obvious: that the depicted shapes relate to actually existing stationary wave states.

We have the choice:

Either we choose the *coexistence* of particles and waves.

Then we have decided upon circumstances which are absurd already by themselves and which, in addition, entail a series of further absurdities: reduction of the wave function, objective probabilities, non-locality.⁴⁹

Or we assume that particles are not indivisible as *substantial entities* but as *dynamic patterns*, because they are stationary wave states, and that, accordingly, particle attributes are *defined* by wave categories.

Then all absurdities disappear, and the whole context becomes understandable.

With this, I shall finish the general part of the local and objective interpretation of quantum theory. In the following sections will be demonstrated, how, by applying our model assumptions to well-known quantum mechanical scenarios, everything which previously seemed to be paradoxical and indeed unexplainable simply disappears.

⁴⁹ If the assumption of the reduction of the wave function is abandoned, then Bell's inequality can no longer be derived, as will be demonstrated subsequently.

3.11. Implementation

In all of the following well-known paradoxes, the decisive step of the elucidation will be the assumption that there is no reduction of the wave function, or, to say it more extensively: that quantum mechanical amplitude squares cannot simply disappear, because they relate always to intensities of existing waves, and that they represent event-probabilities only because events are transitions, which are caused by the continuous accumulation of wave-intensities.

Under this condition, all paradoxes disappear just by themselves, and it becomes directly evident what actually happens.

Let's start with de Broglie's paradox, the

Electron in the Box

Let us assume that in Paris an electron is trapped in a box, the walls of which reflect it. After a short time, the wave function of the electron will be spread out over the whole box. Now the box is divided into two halves by a separating wall, and one half is transported to Tokyo. Then the probability of detecting the electron will be $\frac{1}{2}$ for each half of the box.

If now the half in Paris is opened, then an electron will be there or not, however in any case the Paris measurement will "reduce" the whole wave function and accordingly transform the state of the half in Tokyo from a superposition of the states *there* and *not there* into the definite reality *there* or *not there*.

However from our viewpoint the following applies:

In each half of the box there are electron-waves, and therefore in each half an electron can be found. Whether this will actually be the case depends on the initial conditions in the apparatus used for detecting the electrons. If one of the stationary oscillation states (one of the electron shells) is near enough to the limit where a "jump" into the next state must occur, then an electron will be detected. (See 3.6.)

If the electron appears in one half, then the wave function in the other half does *not* disappear. Thus the connection which the paradox is based upon has dissolved.

Schrödinger's Cat

Here the circumstances are so evident that nothing must be said. There is a transition (an event) or not, and the cat is dead or not.

Not needed are: *act of measurement, observer, awareness, splitting of the universe, decoherence, toad-powder, furuncle extract etc.*

EPR-Paradox

Now then to the second round of the local reconstruction of the EPR scenario. This time we will focus on the connection between the local solution of the paradox and the central assumption of the alternative interpretation of quantum mechanics.

It will be shown:

If the assumption of the "reduction of the wave function" is replaced by the assumption that all waves contained in the wave function contribute to transitions (measuring events), then Bell's inequality can no longer be deduced.

This can be carried out in the following way:

We look again at pairs of photons, which are generated by the decay of spin 0 systems.

We assume that the measurements on one side are not influenced by the measurements on the other side.

Let α be the random angle between the polarization of the left photon and the direction of the left polarizer. Then there are two probability amplitudes: $\cos \alpha$ and $\sin \alpha$; the probability of passing through is $\cos^2 \alpha$, the probability of not passing through is $\sin^2 \alpha$.

If now, as usual, the reduction of the wave function is presupposed, then the probability amplitude $\cos \alpha$ disappears if the photon is not passing through, and therefore the initial conditions of the *next* measurement are identical with that of the measurement just performed. This means: the subsequent measurement is independent from the current one.

In contrast, if the reduction is abandoned, then $\cos^2\alpha$ does not only represent the probability of the appearance of a photon but is *also* the amplitude square of an *actually existing wave* that passes through the polarizer and arrives at the detector.

As this wave does neither disappear nor cause a transition, it will remain in the detector and contribute to subsequent transitions (events). Thus the initial conditions for the subsequent measurements change: these measurements will then depend not only on the waves that have arrived at the detector since the previous measurement but also on the waves that had arrived earlier.

However the angles α are random, accordingly their sequence changes with each test series. This means: the initial conditions of the measurements are never identical, and the measuring results are therefore inextricably bound to the course of the respective test series.

But deducing Bell's inequality involves in any case statements about further, *hypothetical* measurements on the objects which are *actually* measured. The assumption of the reduction of the wave function guarantees that each measurement is independent from all previous ones and therefore also from the course of the experiment. Under this condition, information about further measurements is available.

Without reduction, however, the events cannot be separated from the specific, unrepeatable course of the experiment. Therefore, it is completely unknown what would happen if the same objects were measured once again. Accordingly, Bell's inequality cannot be established. (These conclusions were presented extensively in the first chapter.)

Thus the reduction of the wave function is a necessary condition for the derivation of Bell's inequality. If this assumption is abandoned – in other words: if to the waves is assigned existence so that they cannot simply vanish – then the proof of non-locality disappears.

With this, the decisive step to the solution of the paradox is made: the scenario is freed from the stranglehold of the inequality, and there is no longer any reason to assume that it cannot be described locally. The path to a local description is open.

The following two outlines illustrate these circumstances:

In the case of the standard interpretation, each event pair (EL_i, ER_i) is independent from all previous event pairs and therefore also from the course of the experiment. Thus Bell's inequality applies, and

therefore it is necessary to assume a non-local connection between EL_i and ER_i , as shown in the following outline (R is the number of event pairs):

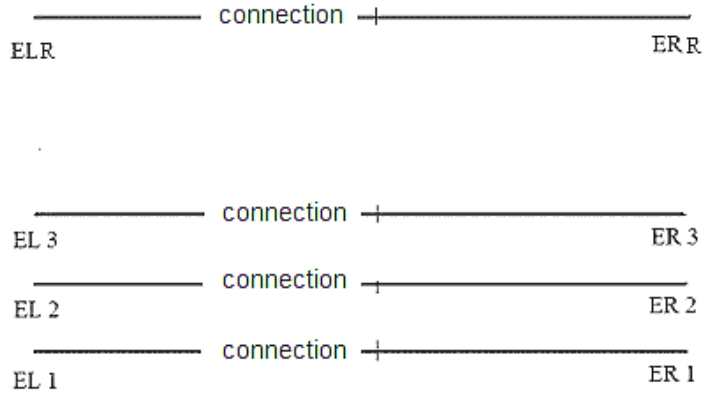

(S11)

In contrast, without reduction every event pair depends on all previous event pairs and, accordingly, also on the specific course of the experiment:



(S12)

Here, Bell's inequality cannot be derived. The *non-local* connection between *spatially separated events* EL_i and ER_i – which is unavoidable in the standard interpretation – is replaced in the alternative interpretation by the *local* connection between *temporally separated events* (in the same detector).

As has already been asserted in the first chapter, the following conditions must be met in a local description of the scenario:

The probabilities predicted by quantum mechanics must be expressed as functions of variables the carriers of which are localized directly at the position of the measurement – i.e. in the detectors. In addition, the structure of the scenario must be adopted: the objects, which carry these variables, must originate at the decay position Z , then pass through the polarizers and finally arrive at the detectors.

The modeling itself follows from the general assumptions of the local and objective interpretation presented in this chapter:

Continuous radiation of waves leads to transitions ("photons"). Thus instead of pairs of *photons* the polarizations of which are perpendicular to each other, we assume the radiation of pairs of *waves* polarized perpendicularly to each other, of which the radiated wave groups are composed.

In the local model, the number of events in a detector must be proportional to the total intensity of the waves that arrive at the detector.

Thus we define random variables as follows:

(δ is the angle between the two polarizers, α_i the random angle between the polarization of the left wave and the left polarizer, accordingly ($\alpha_i+90-\delta$) the corresponding angle on the right side.

$$X_i = \cos^2 \alpha_i \quad (1 \leq i \leq n) \quad (1)$$

$$Y_i = \cos^2(\alpha_i + 90 - \delta) \quad (1 \leq i \leq n) \quad (1')$$

According to our model assumptions, the probability w_L (w_R) of a transition to the left (right) – i.e. the detection of a photon in the left (right) detector – must be equal to the expected value of the random variables:

$$w_L = w_R = E(X) = E(Y) = \frac{1}{2\pi} \int_0^{2\pi} \cos^2 \alpha \, d\alpha = \frac{1}{2} \quad (2)$$

This corresponds to the quantum mechanical prediction.

However the expected value serves only for calculating the frequency of events in one detector. It does not contain any further information. In order to determine the correlation of the events on both sides, however, information about the temporal relationship between these events is needed.

What do the time points of events depend on? Certainly on the time-varying intensity of the waves that arrive at the detectors. Thus the points in time at which photons are detected must be determined by the temporal intensity fluctuations. The degree of these fluctuations is given by the *variance* of the random variables.

The probability of events in *one* detector can be expressed by this variance in the following way: (For the moment, the factors 2 and 1/4 appear arbitrary. They will be substantiated subsequently.)

$$w_L = 2 * \text{Var}(X) + 1/4 = 1/2 \quad (3)$$

$$\text{(Proof: } 2 * \frac{1}{2\pi} \int_0^{2\pi} (\cos^2 \alpha - 0.5)^2 \, d\alpha + \frac{1}{4} = \frac{1}{2} \text{)}$$

The connection between the time-dependent intensity fluctuations on *both* sides is expressed by the *covariance* of the random variables. This suggests the assumption that the probability W_{LR} of the appearance of *simultaneous* transitions on both sides is given by an equation analogous to (3), which contains the covariance instead of the variance.

The covariance is:

$$\text{Cov}(X,Y) = E [(X - E(X)) (Y - E(Y))] =$$

$$= \int_0^{2\pi} (\cos^2 \alpha - 0.5)(\cos^2(\alpha + 90 - \delta) - 0.5) d\alpha \frac{1}{2\pi} = -\frac{1}{8} + \frac{1}{4} \cos^2(90 - \delta) \quad (4)$$

From this it follows that actually applies, analogously to (3):

$$W_{LR} = 2 * \text{Cov}(X,Y) + 1/4 = 1/2 \cos^2(90 - \delta) = 1/2 \sin^2\delta \quad (5)$$

According to (4), the covariance lies – dependent on the angle δ – in the interval between $-1/8$ and $+1/8$. Thus the factors 2 and $1/4$ serve only for mapping the interval $[-1/8, +1/8]$ onto the interval $[0, 1/2]$, which is required for the probability values.

The numbers of the random variables represent their chronological order. Therefore (5) means:

The probability of the simultaneous occurrence of photons in both detectors depends on the degree of correlation of the time-dependent intensity fluctuations on both sides.

At $\delta = 0^\circ$, the covariance reaches its minimum, and there are no simultaneous events at all.

At $\delta = 90^\circ$, the covariance reaches its maximum: in this case the intensities on both sides are at any time equal to each other, and all events occur simultaneously.

Equation (5) can easily be generalized. Let us assume that the angle between the measured photons – which, in our model, is equal to the angle between the emitted waves – is not 90° but has the arbitrary value ζ . Then the random variables are

$$X_i = \cos^2 \alpha_i \quad (1 \leq i \leq n) \quad (1a)$$

$$Y_i = \cos^2(\alpha_i + \zeta - \delta) \quad (1 \leq i \leq n) \quad (1a')$$

(4) remains valid, if 90° is replaced by ζ , and then (5) turns into

$$W_{LR} = 2 * \text{Cov}(X,Y) + 1/4 = 1/2 \cos^2(\zeta - \delta) \quad (6)$$

(6) leads in *all* possible cases to results which conform to that of quantum mechanics.

Essential is the following point:

The results determined by (6) are *local*.

Why? Because the random variables themselves are objective and local: they are amplitude squares of waves which originate from the decay at Z, pass through the polarizers, arrive at the detectors and cause transitions there.

The covariance itself is a quantity by which the linear correlation between two series of random variables is expressed. It is completely determined by the objective, local random variables, and there is no room for any hidden non-locality.

Thus asserting the non-locality of equation (6) is not a possible position. So if one still claims the non-locality of the quantum mechanical predictions, which are in any case equal to the results determined by (6), then the only possible way out is considering this total congruence as *random*.

However assuming this congruence to be random is not plausible because:

1. Bell's inequality does not apply here. Thus there is no longer any reason why a local interpretation should not be possible.
2. The scenario has completely been transferred into the local model.
3. The model was established in accordance with the general assumptions of the local and objective interpretation of quantum mechanics.

Equation (6) provides not only the correct probabilities, it also meets the central condition of a local solution: according to the model assumptions, the events are embedded in the specific course of a measurement series.

Computer Simulation

To determine the convergence behavior, I carried out some computer simulations of (5). Here are the results for 30, 100 and 1000 pairs of random variables and for some characteristic angles δ . (For the covariance, always three results are specified. Rightmost is the quantum mechanical desired value. All results relate to spin 0 systems.)

n = 30	delta	E(X)	2*Cov(X,Y)+1/4			QM desired value
	0	0.486	-0.010	0.006	0.020	0.
	22.5	0.492	0.039	0.075	0.111	0.073
	45	0.502	0.212	0.248	0.283	0.25
	67.5	0.511	0.407	0.421	0.436	0.427
	90	0.479	0.457	0.481	0.494	0.5
n = 100	delta	E(X)	2*Cov(X,Y)+1/4			QM desired value
	0	0.497	-0.012	0.000	-0.029	0.
	22.5	0.484	0.060	0.062	0.042	0.073
	45	0.481	0.243	0.228	0.234	0.25
	67.5	0.488	0.431	0.409	0.436	0.427
	90	0.530	0.498	0.497	0.529	0.5
n = 1000	delta	E(X)	2*Cov(X,Y)+1/4			QM desired value
	0	0.499	0.001	0.004	-0.011	0.
	22.5	0.491	0.073	0.070	0.066	0.073
	45	0.506	0.251	0.241	0.250	0.25
	67.5	0.508	0.431	0.417	0.434	0.427
	90	0.509	0.502	0.500	0.506	0.5

At last it should be mentioned that W_{LR} can also be expressed by random variables of only one side:

Let $I = \{ i \mid 1 \leq i \leq n \}$ be the set of numbers of random variables in the case of n pairs in total.

Let be $I_E = \{ i \mid \text{sign}(X_i - 1/2) = \text{sign}(Y_i - 1/2) \}$, $I_D = \{ i \mid \text{sign}(X_i - 1/2) \neq \text{sign}(Y_i - 1/2) \}$.

$$\text{Let be } SL_E = \sum_{i \in I_E} |X_i - 1/2|, \quad SL_D = \sum_{i \in I_D} |X_i - 1/2|$$

Then follows:

$$W_{LR} = \frac{1}{2} \frac{SL_E}{SL_E + SL_D} = \frac{1}{2} \cos^2(\zeta - \delta) \quad (7)$$

(The proof is similar to the proof of (7) in the first chapter.)

Further commentaries to the 2-photon scenario are unnecessary, as everything important has already been said in the first chapter.

What about other entanglement scenarios? As regards entanglement of photons, there cannot be any problem: equation (6) applies in all cases, also in the case of a single process. Therefore, every photon correlation must be reducible to the specified scheme. This means: the mechanism of photon correlations is explained. Formally, however, everything remains as before.

I didn't investigate other entanglements. However with respect to the original EPR scenario, which relates to position- and momentum-measurements, the following must be stated:

The objects to be measured (e.g. "particles") are wave packets, that is: superpositions of waves.

This means: before measurement, it is impossible to attribute a definite position or a definite momentum to the objects. Even if after the measurement on one object the measuring value of the other object can be predicted, this value still *does not exist before measurement*.

Therefore, before measurement there is neither a definite position nor a definite momentum. In this sense, the attributes "position" and "momentum" do not exist before measurement. Also in the local interpretation they are generated only by measurement – however not due to the reduction of the wave function but by a physical process. (As in the example at the end of 3.7.)

Thus the EPR assumption is wrong, and the EPR reality-criterion⁵⁰ is inappropriate. That we can predict – after the momentum measurement on one side – the result of the momentum measurement on the other side, is a consequence of the symmetry of the processes on both sides and not, as EPR assumed erroneously, a consequence of the fact that the "particle" possessed this momentum already before. Before measurement, there was no particle and, accordingly, no definite momentum.

Notes

1. Before we definitively leave the EPR paradox, we turn briefly to the question of how my arguments for a local reality differ from those which hitherto have been brought into discussion. (I'll start with the answer. The explanation follows immediately afterwards.)

The argument, which I propose for a local interpretation of entangled systems, takes place in a completely different area than the former discussion.

First, an outline of the structure of the usual, well-known bifurcation scenario:

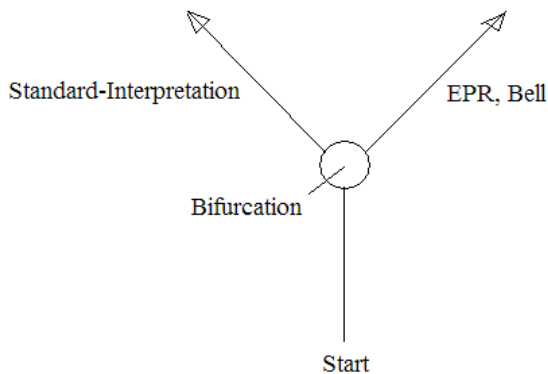

(S13)

Common starting point for all variants is the quantum mechanical description of a pair of entangled objects.

⁵⁰ "A sufficient condition for the reality of a physical quantity is the possibility of predicting it with certainty, without disturbing the system." (Einstein, Podolsky and Rosen, *Can quantum-mechanical description of physical reality be considered complete?* Phys. Rev. 47, 777, 1935.)

At the branch point, however, the views separate in the following manner:

The proponents of the standard interpretation assume that the two measurement events cannot be separated; Einstein, Podolsky and Rosen, on the contrary, claim the separateness of the two events; John Bell takes this position too, but only in order to derive from it a contradiction to quantum theory.

So much for the scenario in which the debate has taken place so far.

My own arguments, however, do not belong to this scenario. They engage lower, at a point where the question of whether the measurements are independent of each other or not is not even in sight.

The following outline serves to illustrate this fact. The scenario of the preceding outline can be found in the upper left part. So here – as shown in the outline – another bifurcation-scenario must be crossed *before* the usual scenario can be reached at all:

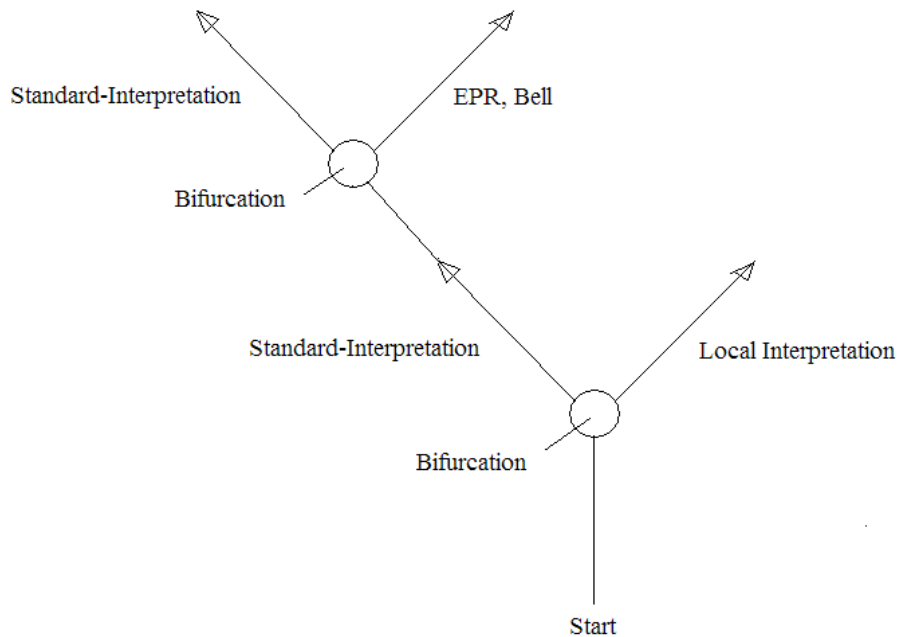

(S14)

Starting point is again the quantum mechanical description of a pair of entangled objects.

Now, however, at the first branch point, it is *not* a question of locality. Rather here a decision must be made about how the *course of the experiment* is to be interpreted, and about what an *event* is and how it comes into existence.

In the standard interpretation, each event pair is regarded as an *autonomous* element of a measurement series, which is *independent of the previous events* and thus also independent of the course of the experiment. This decision leads to the left path, and *only after this decision* the usual, well-known bifurcation-scenario can be entered.

In fact, however, then also the decision about the question of locality has already been made, because – due to Bell's inequality and numerous experiments on entangled systems – it can no longer seriously be doubted that the path which EPR proposed is definitively blocked.

From this follows that on the left path in the outline only the standard interpretation is possible. Thus, here non-locality is a certainty.

But if one chooses the alternative view of the experimental course, in which – as described at the beginning of this section – the *reduction of the wave function does not take place* and in which therefore the events in any case belong to a specific, *non-repeatable* measurement series, such that they cannot be separated from this series, then one is on the path to the right in the outline, and the usual bifurcation-scenario is not at all reached.

Thus, on this path, the question of non-locality does not even arise – the conditions are just analogous to those in the example with the balls in section 1.3, where it is perfectly obvious that there are exclusively local processes.

In this juxtaposition, it becomes also apparent how fundamental the changes are which the view of the quantum mechanical reality must be subjected to in order to maintain locality:

Not only must the definition of the *event* be changed, but also that of the *object*. The definition of *interaction* is likewise affected, and this list can be continued at will.

2. In the standard interpretation, the independence of the actual event from all past events is self-evident to such an extent that the question of whether it can *actually* be presupposed does never arise.

Thus in the standard interpretation the first bifurcation scenario does not exist at all.

Also in this case, the reason is *ultimately*, as in all quantum mechanical interpretation problems, the binding of thought to representational analogies. It is these analogies – in particular the concept *particle* – through which the interpretation is led astray and artifacts such as non-locality are produced.

A model of the measuring process in which objects are seen as *particles* isolates the measuring process and separates it from the past, whereas the *wave model* integrates it into a total process where every event depends on the preceding events – however only if the waves are considered *real*, such that they do not disappear and, accordingly, the reduction of the wave function does not take place.

Paradox of the Two Ways

The paradox, with which the chapter on quantum mechanics started, can be solved using the explanation scheme of the EPR paradox.

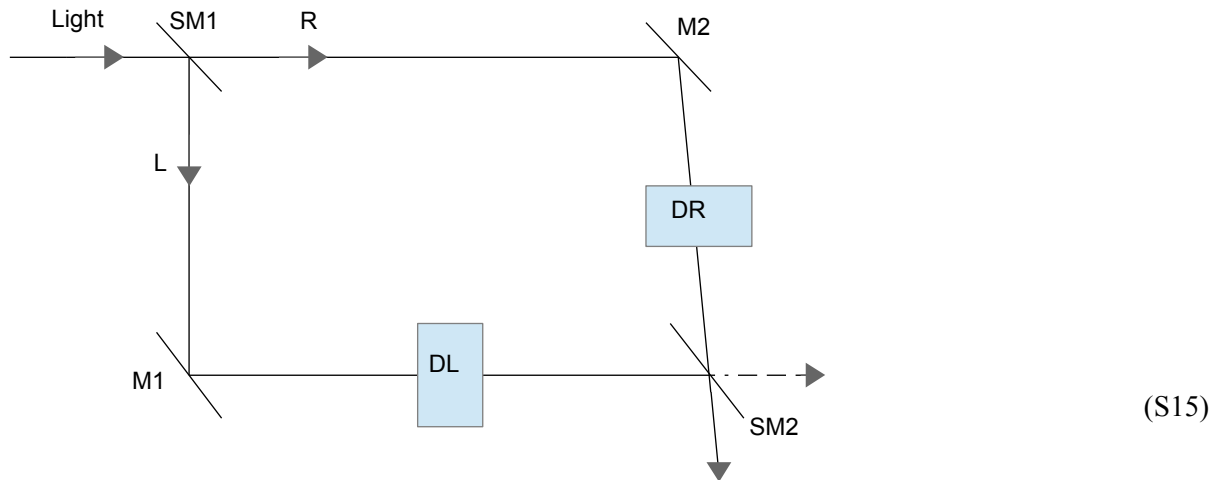

As a reminder: In the usual view, the course of the experiment reveals the following absurdity:

a) If the detectors are in the paths of the light rays, only one detector at a time responds: as the photon is indivisible, it can only choose *one* of the two paths, each with a possibility of 1/2.

b) However if we remove the detectors from the paths of the rays, then we observe interference after the second semi-permeable mirror, which means: the photon (or the light wave) must have been on *both* paths, in contradiction to a).

Since we act on the precondition of waves, nothing must be said about b).

However we have to explain why at a) never both detectors respond, in spite of the fact that there are *always* waves on both paths

For that we use the explanation scheme of the EPR scenario.

There, the random variables X and Y were determined by the amplitude squares of the waves on both sides. Their relationship was determined by the condition that those waves are always polarized at a certain angle to one another.

Here, random variables of the same kind can be defined in the following way:

We assume again that the wave superpositions on both paths are composed of partial waves. Let the amplitude of such a wave before the first semi-permeable mirror be 1. If it is divided by the mirror into two waves with the amplitudes A_L and A_R , then follows

$$A_L^2 + A_R^2 = 1$$

This condition is met, if

$$A_L = \cos \alpha, \quad A_R = \sin \alpha$$

The division is supposed to be random. Therefore, α must be random. (Equally distributed between 0 and 2π .)

Since the expected value of $\cos^2 \alpha$ and $\sin^2 \alpha$ is 1/2, the amplitude square on both sides is on average equal to 1/2. Therefore, the event probability is also 1/2, in accordance with the quantum mechanical prediction.

Now we define:

$$X_i = \cos^2 \alpha_i$$

– where X_i stands for the intensity of a wave propagating along L. Then for Y_i , which stands for the intensity of the wave propagating along R, applies:

$$Y_i = \sin^2 \alpha_i = \cos^2 (\alpha_i - 90)$$

X and Y correspond to the random variables of the previous section, if in (1a') is set:

$$(\zeta - \delta) = -90^\circ$$

Therefore, the probability of simultaneous events on both sides is given by equation (6):

$$W_{LR} = 2 \text{Cov}(X,Y) + 1/4 = 1/2 \cos^2(\zeta - \delta) = 1/2 \cos^2(-90) = 0$$

This means: Though always waves are underway on both paths, both detectors will never respond simultaneously.

Interaction-free Measurements

Quantum mechanical interaction-free measurements are, in the usual view, measurements, where *nothing at all* happens and *yet* something is measured.

The scenario is similar to the one of the previous section:⁵¹

⁵¹ It was presented – in a slightly different form – in 1993 by Elitzur and Vaidman. (Elitzur A. C. and Vaidman L. (1993), *Quantum mechanical interaction-free measurements*. Found. Phys. 23, 987-97.)

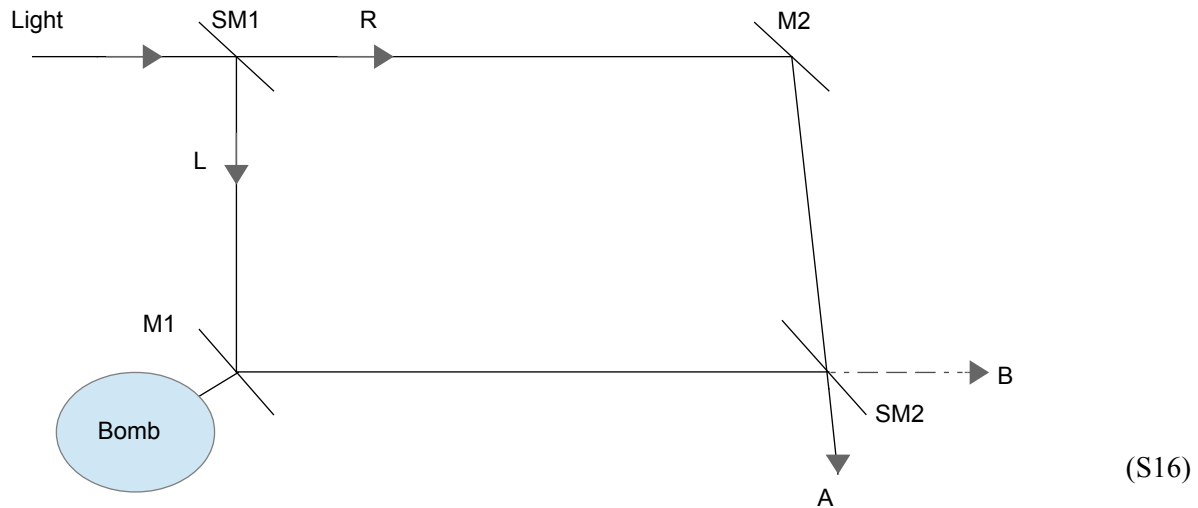

At first the usual description – for the moment without the bomb bottom left:

A photon propagates, starting top left, through the test arrangement. It is split by the first semi-permeable mirror SM1 into the states *passed* and *not passed*, each with probability 1/2.

At the second semi-permeable mirror SM2 both states interfere. The lengths of the two paths are adjusted in such a way that on the path to B destructive interference occurs. Thus the photon will arrive at A with certainty.

Let us now assume we had a series of bombs with the following ignition mechanism: A mobile mirror, which is connected with the igniter, triggers the detonation, if it is moved. The mechanism is so sensitive that the momentum that is transferred to the mirror by one single photon, if it hits the mirror, is sufficient to cause a detonation.

Some bombs are defect: their mirror got stuck. Our purpose is to find a functioning bomb, without letting it detonate at the same time.

Using the depicted arrangement, this can be accomplished in the following way:

The bombs are attached, one after the other, exactly in such a way, that the mirror of the ignition mechanism takes the place of the mirror M1. If the bomb is defect, the mirror cannot move, and everything remains as before: the photon arrives at A with certainty.

However if the attached bomb is functioning correctly, the mirror is movable. This means: the bomb turns into a *measuring device*: it measures which way the photon takes.

If it is on the way L, then the interaction with the mirror triggers a detonation.

However if there is *no* explosion, then it was measured by the bomb that the photon took the way R.

But now, because a measurement has occurred, the interference at SM2 must change, and this means that the probability that the photon arrives at B is no longer zero.

Thus we just have to wait until a photon is detected at B. The bomb, which is in the test arrangement at this moment, must be a functioning specimen.

Therefore, in this description, a measurement took place due to an interaction, which did not occur at all, with an object (photon) that was not there at all. We obtain information by an alteration which was caused by something which did not happen at all.

Of course, everyone who has read up to here knows how these *incredibly fascinating* circumstances are transformed by the alternative interpretation into *completely trivial and understandable* circumstances, which no further thought ought to be wasted on. However, for the sake of completeness, I shall demonstrate it one more time:

For the explanation the following is needed:

1. In the case of an interaction between light and electrons, the assumption of light particles can be dispensed with (as has been shown at the description of the Photoelectric Effect and the Compton Effect).
2. The discontinuous transitions, which are called "photons", are caused by continuous accumulation of wave intensities.

From this follows that, if no transition occurs, it can by no means be assumed that *nothing* happens or *nothing* is there. Rather quite simply the intensity of the waves does not suffice to trigger a transition.

Regarding the bomb-scenario, this means:

If – in the usual view – it is measured by the bomb that the photon took the path R, so that the interference changes and the photon can now reach B, then – as seen from our point of view – this does not mean that *nothing* happened, but that the intensity of the light waves which hit the bomb-mirror – though it did not suffice to trigger a transition and thus to induce an ignition – still caused a displacement of the mirror by a tiny distance, so that the length of the path L and, with it, the interference changed. (And it should be added that this *must* be the case if there are actually existing waves.)

From this point of view, the usual interpretation of the scenario and its embedding into the general interpretation scheme can be described as follows:

First it is stated that the discontinuous transitions between different states of electron shells are elementary and *indecomposable*. The difference between two states is called *photon*.

Accordingly, photons exist only as a whole. From this follows that, if there is not a *whole* photon, there is just *nothing*. And, of course, nothing can cause only nothing, and therefore nothing occurs.

But now, in spite of all that nothing, *something* happens.

However this is not seen as contradiction or at least as reason for some doubt; instead there is just bewilderment about this incredible magic of nature. It is said: "How strange, something which is not there causes a change. Something which does not happen is still a measurement. Forsooth this is a deep mystery!"

This can only be called a crazy prank! Think of a person A who asserts that B, who is in the same room, does not exist. Then B *says* something. Thereupon, A does not simply withdraw his assertion, but instead exclaims: "Oh dear, how is it possible that someone who does not exist can speak?"

However this is also the final point of our elucidations of quantum mechanical paradoxes. With peace of mind, we finish our tour through the quantum mechanical *freak show* – now that we have freed all freaks and transformed them back into ordinary beings.

3.12. *Historical Remark*

The question suggests itself why the local and objective interpretation has not existed up to now.

The most important reason is without any doubt the historically developed connection between physical concepts and the world of things. This connection is unavoidable: the measurable reality consists of things. Therefore, physics must begin with the description of attributes and behavior of objects, just as it has actually happened.

What is to be expected if the investigation of nature – which is based upon the equation

$$\text{force} = \text{mass} * \text{acceleration}$$

– in the course of its progressive conquest of the microscopic world comes across the fact that the fundament of reality is wave-like?

Exactly that what happened at the beginning of the 20th century:

The wave-like nature of being is recognized, but the particle concept cannot be abandoned, because *the whole description system* is based on it.

This leads to the paradoxical and – to put it very clearly – *impossible* idea of objects that are wave *and* particle, and this in turn entails all the other nonsense: reduction of the wave function, objective probabilities, non-locality and what else there is of absurd concept formations.

However to understand the low level of resistance which has been established against the oddities of the new approach, one has to leave the realm of physics itself. That absurdities of this kind were not only accepted but even glorified as intellectual achievements or as "deep truths" can only be understood in relation to the cultural background of that time, which manifests itself in the biographies of the first generation of quantum theoreticians and which is reflected by their convictions. Heisenberg's and Pauli's contempt of Einstein's and Schrödinger's attempts at a realistic and understandable interpretation of quantum mechanics was of exactly the same kind as a Dadaist's contempt of representational painting.

It can be seen very clearly how the cultural background intrudes into the development of physics: at first, the *formal structure* of the theories remains untouched – it is bound to the experimental verification, which does not permit any phantasms. However the interpretation, i.e. the whole

conceptual and notional foundation, becomes part of the historical development and adapts to the cultural constraints. In the first decades of the 20th century, this means: it becomes "Dadaistic".

Unfortunately, that is not the whole issue. The future development is essentially determined by the interpretation. In this way, the cultural background penetrates yet into the formal part of physics, and this is the reason why theoretical physics got stuck in the blind alley where it currently resides.

In short: If particles themselves are not fundamental, then the goal of theoretical physics – the ultimate theory of everything – will not be achieved by uniting the interactions between particles.

3.13. Conclusion

We have great faith in science and in the rational discourse. And rightly so! – It's the best we have. And yet it is an unfortunate fact that just for clarifying really fundamental questions, a rational argument is not always sufficient. There are philosophical positions that are obviously absurd, but nonetheless irrefutable. Such a position is for example solipsism.

Or let us consider two other examples: the assumption of a "supernatural" being that exists "outside" of space and time, and the assumption of a mind that is independent of any material basis.

Evidently, both assumptions are nonsensical. And this certainty does not stand at the outermost limit of thought, where one arrives only after a long path – no, it follows from the *first* step, which reasonable thinking takes on its path to knowledge: to realize that nature – or being, or reality, or whatever you want to call it – is *closed in itself*, in other words: that everything which happens has a natural cause, and that nothing can lead out of this realm. The attempt to establish another principle of explanation besides the natural causality collapses immediately and absolutely at the question of the cooperation between the two principles: Where and how should this second principle apply, when anywhere and anytime the laws of nature are in effect?

This means: if we are not able to comprehend that, which exists and which happens, within a natural context, or if our model conceptions – like e.g. the so-called *big bang* – seem to point beyond this limit, then this gives *never* rise to trans-natural conceptions, but is always an indication for the inadequacy of the models or for a deficiency of the concept of nature which these models are based upon.

Thus there is no reality "outside of reality" or "behind reality". This is understandable in a trivial way and valid without any doubt. It represents, as I said, the beginning of reasonable thought.

Still, it is impossible to convince someone by argument, who has not already realized this evidence himself. Anyone can say that in the upper left corner of his living room hovers his house spirit *Xupatl*, who protects him from evil demons. Typically, he then adds to it that he could not prove that *Xupatl* exists, but that it can also not be proven that *Xupatl* does *not* exist. Any further discussion is pointless. It will not lead to success but only to a nervous condition.

In such cases one may argue and give good reasons, but eventually the argument is exhausted, and then remains as last resort only the appeal to reason. If it is missing – which is usually the case – then the nonsense cannot be eliminated.

Why this deviation?

Because the questions of locality, objectivity and identity must also be seen as such issues.

It is *perfectly obvious* that there are only connections between spatially separated objects, if they are mediated by a process at a speed not greater than that of light. Non-local connections are simply nonsense. But of course, within the horizon of contemporary convictions, first it had to be shown that Bell's proof does not apply and why this is the case.

As this has now finally been achieved, I contend that the locality of reality has already before been completely evident – just in the same way as it is completely evident that neither *Xupatl* nor any other immaterial entity exists – and that the only reasonable question would always have been the question about where the failure in the proof of non-locality lies.

The same applies to the question of the *objectivity* of reality. It is *perfectly obvious* that things are as they are, independently of whether we exist or not and whether we observe them or not. (Of course with the exception of the influence that the physical process of observation has on the observed object. However this influence can be analyzed and is not at all mysterious.)

Finally, the same has to be said about the question of *identity*: the consequences of identical facts must again be identical facts, and not just identical probability distributions of facts. There is no such thing like an objective probability.⁵²

⁵² Actually, already the partitioning of reality into facts and consequences is wrong. Reality consists of *alterations in time* (processes), whose smallest elements are not time *points* but at least time *differentials*. But if

The loss of these three basic principles of any reasonable worldview was only possible because the retreat of theoretical physics into the formal scheme was so complete that any concept of being has dwindled away from physics.

But reality *is not* just mathematics, reality *exists* – thus we have to form a concept of reality that goes beyond mathematics. And in doing so, we will reinstitute reason in the area of interpretation, as indeed *any* concept of reality must meet the postulates of locality, objectivity and identity.⁵³

However if one does not possess any concept of reality at all, then *anything* is possible. Then there is no *reductio ad absurdum*, because absurdity is considered real, and the downfall of reason cannot be stopped.

My intention was to show the following:

If there is no reduction of the wave function, then the principles of reason can be reinstated.

Then particles are no longer elementary substantial entities but stationary wave states or transitions between such states, as long as they are part of a material structure, and otherwise diverging wave superpositions, from which in turn follows that the classical attributes position and momentum do indeed not exist – at least not in the same way as in the case of objects, which possess at any time a well-defined spatial volume.

Seen from this viewpoint, most of the discussion about the completeness of quantum theory and the questions of locality and objectivity has taken place in an altogether wrong area. The solution lies far away from the question of whether the classical attributes position and momentum (and other classical attributes) could be restored as hidden parameters. Rather the following applies: if one holds on to these concepts, then Bell's inequality can be derived and, accordingly, all three principles: objectivity, locality and identity fall victim to this false view.⁵⁴

time-*points* exist only within descriptions and not in the reality, then processes can only be divided into *open* time intervals that overlap each other. Then the concept *process* unites both facts and consequences. If now the concept of identity is applied to processes instead of facts, then there is no longer the possibility of different consequences of identical facts. More on that will follow in Parts Two and Three.

⁵³ Surely, notions like *electron clouds* do not deserve the label *concept of reality*, and the same applies to *interfering probability amplitudes*, *reduction of the wave function* etc. The *black box*, which is presented by the current interpretation of quantum mechanics instead of a thinkable reality, is simply the opposite of such a concept.

However if, in contrast, objects are understood as wave phenomena, then it is evident that the existence of the attributes position and momentum is restricted by an uncertainty relation. In a world consisting of waves, *all* object attributes must be defined by waves, and the fact that for certain pairs of attributes an uncertainty relation applies – which, seen from a classical or a conventional viewpoint, is completely inconceivable – turns into a well-known, intelligible mathematical fact.

Note:

I conclude with a remark which, although it is self-evident and therefore in fact superfluous, still seems necessary to me – given the extreme proliferation of physical and philosophical speculation that originates from the usual interpretation of quantum theory:

With the restoration of objectivity, locality and identity, *all* these speculations become obsolete. Since both the reduction of the wave function and the uncertainty have been explained in a simple and insightful way, it is no longer justified and therefore completely superfluous, to ascribe the act of observation or measurement – or the mind of the observer – any significance regarding the existence of the observed.

Also the various diffuse further speculations that, in some way, in the quantum mechanical facts the mystery of the mind could be hidden – such that consciousness could only emerge "in a quantum mechanical manner" – have lost their justification.

(The question of the relationship between mind and matter will be discussed in the Third Part of this book.)

⁵⁴ As is well known, Einstein has been the last one of the great physicists, who held up the scepter of reason, and it is truly tragic that his strategy – the attempt to implement the classical particle concept into quantum mechanics in the form of *objective dualism* (particles within pilot-waves) – has sealed the surrender of reason by enabling Bell's proof of non-locality.

Everything is going to be alright!

(A very simple, very short **Tragicomedy** in two Nightmares and a Sad Ending.)

First Nightmare

A sunny evening. After a stressful day at the Physics Department you are in your motor-boat, driving towards the open sea.

You stop the engine, sit down on a deck chair and start reading your book “How Universes Emerge”. After a while you feel disturbed by the seesaw. You decide to glide with the waves. You will simply gather pace until the boat speed equals the wave speed, and then you will leave the steering to the autopilot. Then there won’t be any seesaw bothering you.

No sooner thought than done! You accelerate slowly. In no time the boat will be fast enough. Just a moment, just a little moment ... But – how strange, nothing changes. Though you can feel the acceleration, the waves don’t slow down! What is going on here? Still wave after wave is rolling along the boat with seemingly undiminished speed. You pull down the accelerator – nothing changes. Full speed! – no change. Now you become scared. You look around; where are you actually? Can that be waves? Can that be water? Is it possible that there is not any ocean at all? Maybe you are just a moment away from falling into the fathomless abyss at the edge of the world, as the ancestors believed?

Drenched in sweat you wake up.

Second Nightmare

You are walking along the seashore. Gentle wave fronts beat against the quay wall. Around some buoys you can see beautiful interference patterns on the water surface, sparkling in the sun. Pensively you meditate on the fact that in the course of the millenniums the waves are going to wear away the wall, slowly and steadily. All of a sudden, however, you are startled out of your reverie by a loud noise: You lift up your eyes and see that a hefty lump of concrete is being knocked out of the wall and flies away. And after a short time there is the same noise once more, and again a large chunk of the wall takes wing. And again. And whenever this happens, an entire wave front disappears as far as your

eyes are able to follow it. Exactly the same happens with the next wave front: it knocks out a lump of concrete from the wall and disappears at the same time.

You are confused and at a loss. Like in the dream before, you ask yourself what's going on here anyhow. What disrupts the wall under your feet into pieces? Is the earth going to devour you in a moment?

You wake up – however this time not completely. Still half dreaming, you think of your last dream, you remember that there was not any real ocean, not any real water or wave, but merely a strange kind of *something* that behaved like a wave. Now, however, you see that this cannot be true either: something which behaves like a wave could never be able to break such lumps out of a wall! Indeed, this would only be possible if that which you have taken for a wave would turn into a massive lump of hard matter at the moment of its impact on the wall.

Still, how can it initially have existed as a wave – you have, after all, *seen* an interference pattern around the buoys – and thereafter turn into a hard lump of matter, at the same moment disappearing everywhere else?

It is tantalizing. You are not dreaming anymore, however still you cannot wake up completely. You cannot wake up... cannot wake up... simply not wake up... never again wake up....

Sad Ending

You are in a psychiatric hospital. You have not yet recovered from the shock of the second nightmare, and the doctors say you never will. It was just too much for you, too confusing. You sit there, non-stop murmuring. If one concentrates, one can recognize some preposterous words: *complementarity, wave-particle dualism, interfering probability amplitudes, reduction of the wave function, non-local connections...* Some of the other inmates nod insightfully, but nobody else has the slightest idea what all that should mean... Doctors and nurses call you fondly "our brainiac" – with some respect, because of your strange pathology.

Note for non-physicists

Nightmare 1 is the story of Special Relativity.
(Ocean = ether, water waves = light, boat trip = Michelson-Morley Experiment).

Nightmare 2 is about light waves that behave like particles, when they interact with matter – at least according to the generally accepted interpretation which was introduced by Einstein in his description of the Photoelectric Effect –, and about waves that purportedly disappear – in fact all waves except the one that eventually becomes the observed (measured) event. Since Max Born interpreted the amplitude square in the Schrödinger Equation as probability density, this disappearance has become a part of the standard interpretation, although the existence of the waves is *proven* by their interference.

The **Sad Ending** tells about the deplorable condition of the interpretation of physical reality since the Theory of Relativity and Quantum Theory. Still there is no hope in sight that the Dadaistic phase of mainstream physics could come to an end. (Of course this does not apply to the *formalisms* of RT and QT – they are certainly beyond any doubt; the *interpretation*, however, is utterly wrong – or, to put it correctly: up to now it did not even exist.)



4. Concluding Remarks

4.1. Brief Summary

Within the usual conceptual framework, neither in the case of special relativity nor in the case of quantum mechanics can be cleared up which reality the formalism relates to.

In the case of SR, reality has been confused with the formalism already from the beginning. Let us listen to Hermann Minkowski in 1909: "Von Stund' an sollen Raum für sich und Zeit für sich völlig zu Schatten herabsinken und nur noch eine Art Union der beiden soll Selbständigkeit bewahren." ("From now on, space for itself and time for itself shall degenerate to shadows, and only a kind of union of both shall retain independence.")

In the case of QT, there is no interpretation at all but only explanations why there is no interpretation.

In both cases, reality has vanished. This is the reason for interpretive ambiguities and for the occurrence of paradoxes.

This deficiency has been corrected here. In both theories, the investigation of the question of which reality lies behind the formalism and substantiates it has led to a consistent, realistic and understandable interpretation.

In the case of the theory of relativity, this was achieved by the following train of thought:

In various reference systems, the temporal relationships between different positions are mediated by physical processes. The times determined in this way must be unambiguous, i.e. the results must be independent of the chosen process. This is only possible, if there is ultimately only one velocity, that is: the velocity of light. From this follows directly that everything which exists and which occurs must be seen as patterns of superpositions of waves at light speed.

In the case of quantum theory, it was necessary to make up for what was missed in the first decades of the 20th century, when physics came across the fact that anything which exists behaves wave-like.

It has not been recognized that, due to the discovery of the wave nature of being, the previously prevailing description of nature, which was based on the particle concept, has turned from a

fundamental into a *phenomenal* description. Elementary particles were still seen as indivisible and elementary entities, which should now possess wave attributes *in addition*.

However in order to achieve an objective and local interpretation, it is necessary to understand particles as stationary wave-states or transitions between such states. In this new interpretation, "elementary particles" are still elementary, however not *substantially* but *phenomenally*: stationary wave states are indivisible phenomena, and they are also elementary, yet only in the sense that they cannot be divided into phenomena of the same kind – their indivisibility is that of dynamic patterns which correspond to attractors, comparable to standing waves or flow vortices.

Thus there are no longer particles, which lose their existence between observations and turn into superpositions of states with different probability amplitudes, until they jump again into existence at the next observation *as the same particles*. They are replaced by waves, which diverge outside of matter and which, inside of matter – under the conditions given there –, organize themselves to ever the same, *formally identical stationary states*.

Events are always modifications of material structures. Thus the waves appear "particle-like" *in all observations*. Therefore we are subject to the erroneous assumption that, between observations, they would be underway *as the same objects* and, finally, would appear again as *substantially identical* entities.⁵⁵ And then, due to the appearance of interference, we are forced to assign wave attributes to these "particles" *in addition*, and accordingly that which actually happens disappears into the fog of inconceivability.

However it would be inappropriate to claim that the processes which occur in between the events are unobservable. They demonstrate their existence through interference, and, by virtue of their accumulation, they cause – as was explained in the previous chapter – the discontinuous transitions that can be observed directly.

Thus, independently from each other, the substantiations of the relativistic and of the quantum mechanical formalism lead to the assumption that reality consists of waves.

⁵⁵ Isn't this assumption totally absurd? Why should we assume that "particles" are indivisible also between observations and, therefore, remain always *substantially identical* with themselves – even if they lose their existence and turn into superpositions of "probability amplitudes"? At that, in the case of several particles, it leads to wrong results if individuality is attributed to them. So why this clinging on the particle concept, on the idea of *substantial identity* of the observed phenomena?

4.2. Contradiction to the Standard Model

Now is the time to ask what is actually altered by the new view of the physical reality.

Regarding the theory of relativity and quantum theory, *formally* nothing changes. Here, the new view means just a new interpretation of these theories – yet one by which relativistic and quantum mechanical facts are cleared up and the absurdities of the hitherto prevailing interpretations disappear.

But from the change of the approach to the basis of reality, which has been presented here, follows *also* that the theoretical physics has moved in the wrong direction since the theory of relativity and quantum theory. This can most clearly be demonstrated using the so-called strong interaction. As follows:

A substantial element of the new interpretation is that to the waves, whose amplitudes serve for the calculation of event probabilities, is assigned *existence*, with other words: it is assumed that they cannot simply disappear and that the events are actually *caused* by them. Only through this assumption it is possible to restore the locality of the world and to understand what *actually* happens in quantum theoretical measurements.

However, if we apply this assumption to the theory of the strong interaction, we arrive at the following contradiction:

Quarks are bound together by the strong interaction. This interaction does not decrease with the distance. Therefore, quarks cannot be separated from one another.

Neutrons consist of three quarks. In a neutron interferometer, a neutron ray is divided by diffraction at a first crystal layer into two rays, which depart from each other up to a distance of some centimeters. At a second layer, the rays are again diffracted, such that they unite at a third layer where then interference can be observed.

The intensity of the ray can be chosen so low that with high probability there is always only one single neutron in the interferometer. Therefore, *single neutrons* are divided.

This gives rise to the question:

If the neutron is divided – where are then the quarks?

Of course, in the usual interpretation this question is not permitted. It is meaningless to ask what happens between two observations. The elements of the description are nothing but mathematical tools. (However, also here appears, in a most impressive manner, again the strangeness, not to say: the madness of this position: indeed, it cannot be doubted that in both rays *something must be there*, and then the question of where the quarks are is inevitable and, evidently, also unanswerable.)

However in the local and objective interpretation, the amplitudes of the neutron waves are not just mathematical tools – they are seen as *existing* (what they proof by interference!).

But obviously, under this condition, it is impossible – at least according to the current description of the strong interaction – that a neutron can be divided.

This means: the current description of the strong interaction is ontologically inadequate. *This description cannot contain the actual causal connections.*

However if the theory of the strong interaction is wrong, then the whole Standard Model breaks down. It can then no longer claim the status of a fundamental theory but only the status of a purely formal approximation, comparable to the well-known epicycle-system, which once served for the description of the planetary orbits. With this, it is also evident that all attempts to develop physical theories on the basis of the Standard Model must fail.

Here it can be seen clearly how a wrong interpretation leads to the development of wrong theories. As long as this wrong interpretation persists, it will also be impossible to correct the failures caused by it and to create more appropriate theories.

Thus we have come to the following conclusion:

The Alternative Interpretation and the Standard Model (including all theories based on it) contradict each other.

A result of extraordinary importance! However, is there a chance that the Alternative Interpretation can win this confrontation?

I think yes, and here is why: in the decisions that had to be made in the foregoing chapters, there has always been – at least in the fundamental questions – the same most basic kind of choice: *the choice between sense and nonsense*. (Think again of the question of whether waves can simply disappear or not, or the question of what actually happens in the double slit experiment, or the decision between

locality and non-locality, or of the outright absurd idea of "interfering square-roots of probability densities".)

The physics of the last decades, however, has evolved from exactly those assumptions, which we have diagnosed as *nonsense*, and therefore it is irrelevant how long its evolution has already lasted and how much intellectual and financial resources have been invested.

But again: is it actually thinkable that the Standard Model is wrong, that we are indeed confronted with a historical failure of such scope?

Again yes, and the explanation lies precisely in the fact that the whole theoretical structure is built on wrong presuppositions. Exactly those deficits and errors in the interpretations of the theory of relativity and of quantum theory, which have been criticized and corrected in the foregoing chapters, have been adopted as basic assumptions.⁵⁶

However the chance to eliminate erroneous assumptions exists only for a limited time period. Afterwards, the general attention is inevitably directed toward other issues, and the unsolved questions pass into oblivion.

Thus the next chance to correct the old errors does not appear before the problems caused by them have ultimately become so important that they can no longer be ignored. If the actual cause still remains hidden, then the whole system can break down.

It cannot be denied that the latest physics exhibits some features that indicate such a state. Not least, it is the absolute lack of success of superstring theory, which suggests this view.

⁵⁶ Most important is again the particle concept. The theoretical physics of the last decades is based on the assumption that the group structure, which is formed by the elementary objects of the reality and the operations that can be performed with them, represents the *fundamental* level of description. This assumption carries all presuppositions that thwart the understanding of the reality: substantial identity of the objects (– this is precisely the particle idea; more on this issue follows in the next Section), non-existence of the waves, indivisibility etc. The elements themselves and the operations with them are presupposed, such that they cannot be deduced from the theory.

This idea of reality is in maximum contrast to the view presented here, where all phenomena are dynamic patterns.

4.3. *Hidden Ontology*

The problem to understand quantum theoretical measuring processes, in which the wave function collapses, is caused by an ontological assumption that is hidden in the standard interpretation. Its content is exactly that what we previously called *substantial identity of the measuring objects*. This means the following:

First, the measuring object is *generated* (prepared). Then it crosses the experimental setup. Finally it is *detected* (measured).

Here, however, it is unconsciously and, so to speak: completely automatically presupposed – not only within the framework of the standard interpretation but indeed by *anyone* who has ever commented on the interpretation of quantum theory – that that what is *generated* and that what is *detected* is *the same object*.

Also those who consider themselves free of any kind of ontology – no matter whether they are pragmatists or positivists – still presuppose that the *generated* and the *detected* object are one and the same object.

Therefore, even when you try to avoid any ontological assumptions and beware of interpreting the phenomena as "particles" or "waves" or whatever else, you have still made a far-reaching *ontological decision*: precisely that one which – as has been shown in Chapter 3 – makes it impossible to understand what happens.

I remind you of what *actually* goes on in the double slit experiment: After the measurement object (e.g. an electron) has been generated, it passes the double slit, interferes with itself and hits the detector plate – with an intensity whose distribution corresponds to the distribution of the measured events.

The generated object, however, is by no means identical with the detected object: the detected "object" (which is actually a transition between two oscillation states) owes its existence not only to the wave intensities that just now have been present at the position of the detection, but also to wave intensities that have earlier arrived there, and also to such ones that have already been there before the experiment started.

In the description of the double slit experiment, I stated (in the first note) that it is the unconscious application of the "ball-throwing analogy" which rules out any possibility of understanding. This analogy is also appropriate to illustrate the seemingly obvious assumption of *substantial identity* of the

objects: it would be outright crazy to doubt the identity of the *thrown* and the *caught* ball. Unfortunately, it is equally crazy to transfer this identity to atomic and molecular circumstances. If this is done – and I emphasize again that up to now this has invariably been the case – then the explanation of quantum mechanical measuring processes is completely ruled out.

Therefore, it does not matter which further assumptions are made or whether any assumption at all is avoided – no, in order to thwart any kind of understanding, it is indeed entirely sufficient to presuppose the *substantial identity* of the generated and the detected object. And, moreover, as has just been shown, this presupposition induces the development of wrong physical theories with which physics is eventually led into the dead end where it is currently trapped.

I'm speaking of *substantial* identity instead just of identity, because the decisive point is the differentiation between *formal* and *substantial* identity. *Substantial identity* is a concept that can be applied to macroscopic material objects. *Formal identity* is a concept that fits to dynamic patterns.

Here is an example for the latter: A river vortex X is *formally*, but of course not *substantially* identical with another vortex Y that appears further down in the same river bed under identical boundary conditions.

The same applies to all phenomena, when they are seen as dynamic patterns. E.g. in the case of the double slit experiment, the generated "electron" is *formally*, but not *substantially* identical with the detected electron. In the same way as the vortex, the detected electron is a phenomenon that has been *newly formed* in identical shape under identical boundary conditions, and this applies also to the neutron that has been detected after the interferometer.

In the Alternative Interpretation, the world is formed by waves. Therefore, here all phenomena are stationary wave patterns, and the concept of "substantial identity" proves to be ontologically altogether wrong. However, in the realm of everyday experience, its application is rather unproblematic, because there the objects are of a magnitude in which they are long term stable, such that they remain identical with themselves in all processes – as e.g. a thrown ball.

However, in atomic or molecular magnitudes the objects are only conditionally stable. Under certain conditions, they dissolve into the waves of which they are made and lose their identity. Later, these waves can contribute to the formation of *formally identical* objects.

Therefore, the concept of *substantial identity* cannot be transferred to the world of the smallest things. If this is still done, then its ontological wrongness manifests itself through the fact that the events become uninterpretable.

4.4. Outlook

Let us now turn to the question of how the future of physics could be look like on the basis of the Alternative Interpretation; what will be the direction of the search for simplification and unification?

In the following, I shall present some basic considerations. However I will be brief, because from the position achieved so far the answer can only be guessed, while from the position that will be taken in the next part it appears quite naturally and in a distinct form.

Particles carry charges. If a particle is seen as wave state, then the charge must be attributed to this wave state. With this, an important adjustment takes place. As mentioned above, there is a fundamental difference between particles and waves: a particle is connected with its attributes only *by definition*, whereas the attributes of a wave *follow logically* from its dynamics. Thus, effects caused by a particle are just part of its definition, whereas effects caused by a wave must be substantiated by its dynamic form.

In short; waves must interact *as waves*, and if the interaction reaches out into space, then this process must be *wave-like*.

This means:

1. Every field must be deducible from the dynamics of the stationary wave states which are the sources of the field. What in the case of particles is only an act of definition, turns – due to the transition to waves – into a logical connection.
2. Every field is ultimately a wave field which is defined by frequencies, wave-lengths and phase-relations.

Let us go back to the question of the unification of interactions. How can it be achieved under the conditions of the wave model of reality?

To answer this question, the following must be taken into account:

First I shall repeat the considerations of section 2.12.

It is unknown what oscillates in the case of light waves. The answer: "The electrical and magnetic field vector" cannot be accepted – that would be the same as if, in the case of water waves, the water was removed and then stated that now kinetic and potential energy take the place of the water. The *subject* of the periodic change, which is the basis for the wave propagation, cannot simply be replaced by general description quantities.

The same question appears in quantum mechanics. What is it which the amplitude of the Schrödinger equation relates to? It is impossible to assign this amplitude to any known physical quantity.

If one accepted the – inadmissible – replacement of the *subject* of the periodical alteration by description quantities, then it would also be possible to attribute different charges to different waves. However there *must* be a subject of the oscillations. There has to be *something which* oscillates, and, as just mentioned, this existing "something" cannot simply be replaced by pure description quantities.

Therefore, even if we don't know *what* changes periodically, it is perfectly clear that, due to the above train of thought, that which oscillates must – as an existing entity – be *the same* in all waves. All waves exist in the same space, and therefore the *subject* of the oscillation must be identical in all waves; all amplitudes have to relate to the same entity: A *description quantity* can simply be superimposed over another description quantity, but *anything existing* can *not* be superimposed over anything existing: what exists claims its place in space and time exclusively for itself.

Thus we have come to the conclusion that all waves must be of the same kind – in the sense that that which oscillates is in all waves identical. At the foundation of reality, there are no different kinds of waves.

But is it possible at all that the interactions could be unified in this way? Does a single kind of waves leave enough room for the derivation of all interactions?

Seen from the Alternative Interpretation, however, this question is not admissible, because – as has been shown just previously – the current descriptions of the strong and weak interaction are nothing but ontologically inadequate approximations and have therefore lost their status as fundamental theories.

So let's resume our train of thought. We concluded that there is only one kind of waves, from which all interactions must follow.

Now we are only one step away from the *law of everything*:

If that which oscillates is in all waves identical, then all waves must conform to the same law. And as these waves are indeed everything which exists and which occurs, *everything* must conform to this law.

We are standing before the *mechanism of the universe*:

It is the law to which the propagation of the waves conforms.

That's all, and it's surely a surprise. Within the current range of interpretations, it seems even absurd. However this frame has now changed essentially, and, starting from the new interpretation, only a few steps are needed to arrive at this surprising conclusion.⁵⁷

It may also be considered surprising that with a *law of everything* of this kind, one possesses actually very few information. In a universe based on such a law, everything which exists must be a wave pattern that has emerged by self-organization. However the propagation law of the waves alone does not provide any information about such pattern-formation processes. Patterns develop only in connection with certain boundary conditions.

Think for example of the sound of a jar: the shape of the jar determines the spectrum of the sound. The wave-pattern is completely determined by this shape; the propagation law of the disturbance determines only the speed of the propagation and, with it, the frequencies of the oscillations.

And this is also the proper analogy for the new interpretation:

There are only waves. Everything which exists and which happens is a wave pattern. The universe can be understood analogously to an oscillating body, which organizes itself into wave patterns.

But it is just an analogy, and it will be replaced by a more abstract concept in the Second Part. After all, however, it is appropriate to illustrate the contrast to the usual view, which was presented at the beginning of the introduction using Feynman's statement:

⁵⁷ Indeed, this result is already contained in the explanation of special relativity. It ensues directly from the fact that there is only light speed and that, accordingly, everything which exists and which occurs must be understood as interference phenomenon, as wave pattern.

However, without the wave-interpretation of quantum mechanics, it would have remained entirely vague how a reality of this kind could be designed. The distance to the usual way of physical thinking is just too great.

"All things are made of atoms – little particles that move around in perpetual motion, attracting each other when they are a little distance apart, but repelling upon being squeezed into one another."

The transition between the two concepts of reality can be described in the following way:
In the usual view, the discrete, particle-like phenomena are considered fundamental.

The alternative view is based on the assumption that *below* this layer of discrete phenomena a continuous, wave-like fundament of reality exists, which contains the *actual* causal connections.

This fundamental layer, however, is by no means an invention of the Alternative Interpretation – it is just a part of the quantum mechanical formalism. The difference is that, in the conventional interpretation, it is declared *non-existent*, whereas in the Alternative Interpretation it is considered *existing*.

As a summary, it can be stated:

The conception of different fields, by which various elementary entities interact with each other, is replaced by one single relation between differentially adjacent points.

Already at the beginning of the Second Part we will deal with the mathematical form of this law, of which, for the moment, we know nothing but that it exists.

Epilogue

The character of a civilization is reflected in its attempts to explain the origin of the universe and its evolution.

Therefore, in a civilization whose fundamental explanation of the world includes absurdities like those which are currently part of the interpretation of physical theories, reason and enlightenment must inevitably give way to other, more primitive ways of thinking and dealing with the world. On such an irrational basis, seemingly without any chance of understanding anything, every attempt to build a reasonable concept of the world – even outside of physics – is doomed to failure. However, without such a concept which – whether we are aware of it or not – represents the background of our thinking and acting as well as of our values and intentions, the meaning of life is in danger. If the discrimination between sense and nonsense gets lost at the fundament, it will ultimately dwindle away everywhere. If our apparently deepest insight transforms the world into a black box and our attempts to describe it into an insane babbling, then eventually we will turn completely into idiots.

All cultural phenomena depend on each other. It may happen that characteristic developments within different areas do not proceed simultaneously. However this does not affect their mutual influence. Therefore the paradoxical assertions of physics (the so-called wave-particle dualism, the non-local, non-mediated connection between measurements performed arbitrarily far away from each other, the reduction of the wave function etc.) are not just exotic and elitist baubles – rather they must be considered as symptoms of the ominous condition of the contemporary cultural subject. And, moreover, the leading position that physics possesses turns such assertions into deep rips in the already fragile enclosure of the area of reason, through which the old, eventually vanquished demons can invade again. There is hardly an esoteric that does without a reference to Quantum Theory. A wave of irrationalism flows over the world. In the borderlands of science, a weird alliance between esotericism and physics has developed which long ago has encroached upon everyday thinking; almost everyone who comments on ontological issues appears to be captured by the same kind of madness.

However all that would be nothing but an irrelevant chattering, if the current interpretations of physical theories were actually determined by the inherent necessity in which physicists see themselves trapped, so that the failure of reason and the retreat into mathematics were unavoidable.

What is the world? Is its innermost core in fact of such absurdity as the current physics would have us believe? Or is it still possible to give reasonable and understandable answers to the fundamental questions to which theoretical physics has led us?

If you have made yourself familiar with the concepts presented here, you will agree with me: What happens on the bottom of things is neither absurd nor inaccessible. It reveals itself to our thinking and can be understood by us.

If we only remove the label "no trespassing" and start with the thought path that leads us to the knowledge of how the fabric of reality *actually* is produced – then we will neither get lost in the almost impenetrable fog which Niels Bohr, Werner Heisenberg and their followers have sprayed over the whole scenario, nor fall prey to the madness of which Richard Feynman has warned us, nor plunge into a bottomless abyss – no, we will just meet the "glittering central mechanism of the universe in all its beauty and simplicity."

And this very knowledge could be the remedy for the current epistemological disorientation and its fatal cultural consequences: it forms the basis from which reason and enlightenment can unfold anew.

Open Letter on the Status of the Global Civilization

Dear Reader,

Recently, the celebrated abstract painter F. met the painting gorilla Hedwig, who – as is generally known – is considered by some of the most distinguished art critics as the *great dark hope* for the renewal of postmodernism. Reportedly, the encounter of the two artists was very fruitful. On the very same day, after deeply meditating and retreating into ancient mysteries, the peerless performance artist N. succeeded in crapping a figure of such majestic sublimeness that many spectators – amongst them several politicians – spontaneously fell to their knees and burst into tears.

Just at the same time, the famous physicist D. consulted the shaman *Pregnant Cloud* for comparing the *Reduction of the Wave Function* with the shaman's dream of the *All-Creating Gaze of the Great White Bird* and for clarifying the obvious connections between the physical concept of *time traveling through wormholes* and the closely related shamanic concept of the abolition of time by alcohol and other drugs. Likewise simultaneously, the physicist H., in former times one of the most prominent string theoreticians, in the end obtained *Satori*; After a three-year period of heavy suffering, sitting naked and lonely on a tower in Cambridge, chafing his ass up to his tailbone, he realized that the ultimate Theory of Everything is *unthinkable*, because the *Tao* which can be thought, cannot be the true *Tao*.

Further amazing events followed immediately: The genetically optimized sheep Kitty – a creature designed by the geneticist A. – declared to be much more intelligent than its creator and claimed his job, the brain researcher R. averred desperately he was just the unconscious speaking tube of his neurons and could therefore not stop talking nonsense, the Born Again Preacher Q. announced the beginning of Armageddon with an accuracy of *one millionth of a second* (Jerusalem local time, of course), and the Philosopher S. emphasized that all these incidents were *very serious issues* that should be kept under tight surveillance.

I deeply regret not to have witnessed these exceptional events directly, all the more since their temporal coincidence indeed cannot be considered accidental but has to be attributed to the influence of the morphogenetic field that caused the enormous cosmic tension, which could be felt so strongly in recent times. Without any doubt the long-expected intellectual jump of mankind is impending.

Where will it lead to?

Dear Reader! – I would not dare to invite you – from these climaxes on the intellectual peaks of the present where I imagine you breathlessly dedicated – down to the lost lowlands of simple reason, which seems to have vanished long ago but has been recovered here, if the yield was not so overwhelmingly rich. However it would be irresponsible not to warn you: With reason it is the same as with other strong drugs: if you are not prepared for it, it can lead to some pain, to a shock or even to death by brain arrest – especially after such a long time of abstinence.



Part Two

Physics from Metaphysics

The Elementary Concept of Reality

The Metric-Dynamic Universe

Attunement

Highly-esteemed Reader! – What is the primordial ground of reality?

Since I am not completely satisfied with the approximately valid *standard model* and also not quite happy with the correct answer "42", and because overzealous animal rights activists have thwarted the execution of my plan to let 10^{500} apes type until they produce a theory which is more prolific than the *superstring theory*, I decided to search for an answer on my own.

But now I fear that the result of my search might appear too strange to you. So I racked my brain for how I could pump you up into a rather yielding mood.

And, lo! – out of my racked brain a fortune cookie emanated that contained a proposal for a ritual the execution of which will put you into such a devotional euphoria that you are immune to the feeling of alienation and to an inadequately critical attitude.

Ready?

Then please sing *maestosamente e con forza* three times in succession the following motif:



And now we have to hurry! – We must make it through the first few sections before the effect wears off!



1. The Primal Ground of Reality

1.1. Announcements

In this Part, as announced in the introduction, the physical description of reality will be derived from metaphysical considerations.

How is this to be done?

By reversing the direction of physical reasoning: The observable phenomena, which – according to usual conviction – represent the starting point of the description of nature, will be the endpoint, and that which is considered the ultimate goal of physical knowledge – the law which includes everything that exists – will be the starting point. This is possible, because the ontological and logical conditions of the primal scenario, from which everything existing follows, are of such simplicity that the law that belongs to this scenario follows conclusively from these very conditions.

If the description of nature originates, as has been the case in the historical development of physics, from experiences that come from observations of objects in our environment, then at first the elements of the description seem obvious. What could be clearer than the concept *force*, or the concept *work*, defined as path integral of force, or the concept *energy*, defined as ability of an object to perform work?

As the development of physics demonstrates, however, these matters of course turn out to be illusions. By leaving the mesocosm the vividness of the anthropomorphic notions fades away more and more, until at last only mathematical definitions and measurement regulations remain. At the same time, any demand for an interpretation beyond this restriction disappears. The conceptual network which originated from objective experiences and was designed for understanding nature degenerates to a mere adjunct of mathematics.

The consequence is that the interpretation of physical theories finishes up in a blind alley, from which there is – as was shown in the First Part – only one escape: the status as *basic concepts* must be withdrawn from some of the notions that stem from the world of things, and other concepts must take their place.

However the retreat into mathematics is problematic not only for this reason, but mainly because – as will turn out in the following – it is ultimately the difference between a mathematical object and an

actually existing object which permits to answer the two questions: *Why is there anything at all and not just nothing?*" and *"What is that which exists"*, and which enables us to determine this Simplest and most General from which being evolves and from which the description of physical being can be derived.

More concretely, the program of the Second Part reads as follows:

At first, the scenario is determined that represents the *Primal Ground of Reality* and of its description.

From this scenario follows the fundamental equation, where "fundamental" means that this equation describes the *process that generates the reality*, so that everything which is derivable at all can be derived from it.

From this purely philosophically motivated and substantiated initial equation, a very short path leads to special relativity as well as to Newton's and Einstein's gravity. The according structural concept, however, changes completely in all three cases.

In an analogous way – and just as directly – the same equation is also the basis for the definition of the electromagnetic interaction. From this starting point, a simple atomic model can be created which, as far as it will be carried out here, is identical with the quantum mechanical model.

Also with the electromagnetic interaction, a fundamental change of the concept of the underlying structure takes place.

Conventionally spoken, one could call the method a *geometrization* of physics. However it is far more: physical concepts and relations are not just geometrized – they are *newly substantiated*: the concepts are reduced to one single concept, and the relations are reduced to one single relation.

I will perform the reconstruction not systematically but in all cases far enough that the connections to the respective theories – in the form as they are currently understood – as well as the differences can be seen clearly.

At last follows an outline of the universe as it ensues from the hitherto acquired results. In this image of the cosmos and of its development, the concepts *dark energy* and *dark matter* find a simple explanation.

Given the strange intemperance of these announcements, it seems appropriate to add a personal note:

I started my cognition-project only with the intention to eliminate what – from my perspective – had to be seen as intolerable interpretational shortcoming of present physics. The realization of this project led to the conclusions contained in the First Part of this treatise.

I've never thought of designing a new kind of physics – such an idea would have seemed absurd to me.

At some point, however, I started thinking – at first not seriously, rather incidentally, in a moment of playful audacity: if there is *anything* at all, *how* must this "anything" be designed? – and from then on, everything developed straightforwardly. More and more physical regularities were revealed to me in the simplest geometric form, and all that happened with such compelling logic that, finally, I could not get rid of the impression that that, what unfolded before my eyes, could actually be a picture of the universe *as it is*.

Before I start with the actual train of thought, I will outline shortly, what I consider unsatisfactory regarding the *standard model* and also the speculative developments beyond.

1.2. Criticism of modular Universes

The considerations of this section are not yet part of the reconstruction of the description of nature; so for the actual reasoning, they are of no importance. However for my own thinking, they have been necessary, and I shall present them here, because they seem appropriate as introduction – insofar as they put into question what at present is considered so evident that it is not even an object of discussion: the assumption of *elementary objects*.

What is meant by the term "modular universe"?

Just that: the model of a universe in which there are entities that are considered *elementary* (e.g. particles or fields), in the sense that they are indivisible, their existence cannot be substantiated and the quantities connected with them (attributes of the elementary entities, ratios of the values of these attributes) cannot be derived.

Such *elementary entities* and *natural constants* are then unexplainable *by definition*.

The question arises, *how many* of such irreducible quantities, such "free parameters" are acceptable at all: 10^{500} , or 26, or perhaps only 3? (Also the number of elementary entities and the number of free parameters can be free parameters.)

The answer is:

*None at all. Each free parameter that cannot be derived for reasons of principle is an indication that the fundamental level of description is not yet reached.*⁵⁸

The uneasiness that captures most physicists in view of the free parameters of the Standard Model concerns not just the number of these variables; much rather it relates to the questionability of a *non-contingent being* – where *non-contingent* means: not originated and not reducible.

There is no non-contingent being. Everything which exists is contingent. This applies to the fact of its existence itself as well as to its attributes.

The network of contingency is *all-encompassing*. On the side of the description, this means that – at least in principle – it must in any case be justifiable why any being exists at all and why it has exactly those attributes.

However, this principle of contingency is of the same nature as the principle of objectivity or the principle of locality: it cannot be completely substantiated but only be recognized. Just in the same way as it is logically possible to assert that there are connections mediated by nothing, it is also logically possible to assume, the primal ontological ground of the universe consisted of a number of elementary objects – and apparently most physicists indeed share this opinion.

I consider both assumptions implausible. To me the idea, the universe could resemble a building set with a certain number of basic elements, seems (almost) as absurd as the assumption of un-mediated connections. I think, basically nobody would be content with the idea that there are quantities which are unexplainable *on principle*.

However, at present there is actually no alternative: the two most common assumptions, God or chance may be responsible for the specific values of the free parameters of the standard model, are indeed no explanation. As already mentioned in the introduction, they can be compared with jokers in a card game: they can be used to take the place of any required explanation, but actually they explain nothing at all. The notion "god" merely glorifies our ignorance, and the assertion of randomness only postpones the need for a *real* explanation and shifts it to a deeper – at best simpler – level where the same questions occur again.

⁵⁸ It should be noted, however, that some of these parameters could have emerged from self-organization. Parameters of this type would not be derivable directly from fundamental equations.

So if one wants to meet the postulate of universal contingency and, at the same time, to avoid the two unsatisfactory alternatives, then one has to abandon the assumption of elementary entities.

Then, however, one seems to fall victim to an infinite regress: if *all* entities have originated from other entities, then there is no ontological starting point.

Thus one seems to be trapped in the well-known antinomy: either one *defines* such a starting point – just like the elementary entities in physics or like the *ens a se* (the *unmoved mover*) in religion – or one gets into the infinite regress. Evidently, in both cases the possibility of an explanation of that which exists disappears.

It will turn out that this antinomy can be solved in the same way as the antinomy regarding the question: "Can objects be divided infinitely or is there a limit of divisibility?"

The answer was given in the First Part (which however was not explicitly mentioned there): There are indeed indivisible elements of reality, but not in the sense presupposed in the antinomy, where the continued partition of a *solid, substantial body* is put into question. Instead, any indivisible object is a *gestalt phenomenon*, a dynamic pattern, which can only exist *as a whole* and is *therefore* indivisible – just as a vortex or a standing wave in a tube.

It can be seen clearly how the antinomy could be solved: by a change of the presuppositions of the question, which previously appeared quite natural – and the same applies to all antinomies, thus also to the seemingly unavoidable alternative *elementary entities* or *infinite regress*.

So let us get on the path to the primal ground of reality, the last precondition of all being.

1.3. Why there is Anything and not Nothing; The Origin of Everything

Preparation: the Difference between Reality and Description

The difference between *objects of reality* and *objects of a description of reality* is as trivial as fundamental:

Everything that *exists* exerts *effects*. Expressed in everyday language: it has attributes; expressed in the language of physics: it interacts with something else that exists. Thus the characteristic of *actually existing objects* is that they *change* their environment. One could say: they are **active** *by themselves*, or *out of themselves*.

In contrast, *thought objects* – regardless of whether they are elements of a verbal or a mathematical system – *do not* exert effects; their effects are merely *imagined*. Only if they are used by somebody, they can become part of a process, i.e. of a thought train, a conclusion or a calculation. *By themselves*, or *out of themselves*, they are **passive**.

Effects must emanate *from something*. Thus in the case of *existing objects* there must be a *carrier* of the attributes.

Think of the example which served to illustrate these facts already in the First Part: water waves. Obviously, they are waves *of the water* – and it would be very strange to say that there were no water, and the waves were just the periodic conversion of kinetic into potential energy and vice versa.

Or another example: the Cheshire cat in *Alice in Wonderland*. It disappears, and only its grin remains. Lewis Carroll is playing here an absurd and entertaining game with our knowledge that there can be no grin without cat. He ignores the necessity that there must be *something that* grins.

Exactly the same applies to light waves. Who asserts that light waves *are* the periodic conversion of electric and magnetic field plays the same game as Carroll: Just as the grin presupposes the *cat*, or as the kinetic and potential energy presuppose the *water*, also the electric and magnetic field presuppose a *carrier*. This carrier cannot simply be replaced by the effects that emanate from it.

However on the side of the description, there is no such problem: Of course it is admissible to describe water waves as periodic transformation of the two forms of energy, and it is entirely correct to describe light as a vibration of the electric and magnetic field vector, and at last it is no problem to draw the

grin without the cat and depict its effect on Alice – and I do not mean that as a joke: it is in fact always the same situation, and in each case it reveals the difference between reality and description in the same way.

This difference can be expressed in the following way:

Actually existing objects consist always of *substance and accidents*.

Here, the notion *substance* stands for exactly that, which represents the answer to the questions: "*What is the carrier of the attributes?*" or: "*From what do the effects emanate?*" Its meaning will become clearer in the course of the subsequent thought train (and of some other ones that will follow later). The same applies to the notion *accident*; here, it means just *attribute*.

In contrast, *objects of a description system* consist *solely of accidents*.

Let us look at a mathematical object: it consists of nothing but its definition, i.e. exclusively of attributes. A mathematical object exists only *as* its definition, it has *no existence* without this definition. Its designation is merely the "shortcut" of its definition, the "placeholder" of its attributes. There is *no carrier* of the attributes.

An example: natural numbers consist of the Peano-Axioms, by which they are defined. Every operation with natural numbers relates to this definition. If it is removed, then what remains is not objects without a definition but *nothing*.

In other words: mathematics is only structure, reality is structure *and* substance.⁵⁹

Another illustration: The term *electron* can designate a mathematical object or the object in the real world which is represented by the mathematical object. To understand both objects as *one and the same object* means identifying mathematics and reality. By this very act, reality is deprived of its substance. The maximum congruence between description and reality is not *identity* but only *isomorphism* – and this applies only to accidents.

⁵⁹ Here, "structure" can also be replaced by "information"; Information needs a carrier too.

The Search for the Origin

Now the preparations are made for asking the crucial question: the question which leads out of the realm of being and directly back to the fundamental level of reality – to the *origin of everything*. It reads as follows:

What is the carrier of the attributes?

As long as the respective object is *composed*, that is: a complex aggregate of simpler components, a *reductionistic* answer can be given.

But what is in the case of an object that cannot be further reduced (divided)? *What is that from which its effects emanate?*

The carrier of the object attributes is defined as that from which the effects emanate, or, to put it another way: as that what the object is *without* the accidents, or again in other words: as that which remains if (mentally) *all* attributes (interactions) are removed.

However the presence of attributes is a *necessary condition* for ascribing *existence* to an object: something which interacts with nothing else does not exist. Therefore, the carrier of the object attributes does not meet the criterion for existence.

Let us therefore *firstly* state:

*The carrier of the object attributes **does not exist.***

On the other hand the following applies:

As mentioned above, from a mathematical object do not emanate any effects: out of itself it develops no activity. Therefore, from a mathematical object actually nothing (or just an empty notion, or a name) is left, if the attributes are removed.

But from an *actually existing* object emanate effects, and, therefore, from an existing object cannot remain just nothing if its attributes are removed. Something, from which effects emanate, cannot just *not exist*, because from something that does not exist cannot emanate effects. *Nothing* cannot be carrier of attributes.

Let us therefore *secondly* state:

The carrier of the object attributes does not not-exist either.

Thus it follows: ***The carrier of the object attributes does neither exist nor not-exist.***

That from which the effects of an object emanate, is *attribute-less*, therefore *indistinguishable*, i.e. identical for all objects. Thus we can interpret it as *precondition of every being* and – since it is not just a *logical* but an *ontological* precondition⁶⁰ – at the same time as *origin of every being*, and therefore it holds:

The *origin of everything* does neither exist nor not-exist. It is neither something nor nothing.

Every being can *be* or *not be*. But for the *origin of everything*, which itself is no being, this alternative does not apply. But behind the alternative *be* or *not-be* or *something* or *nothing* there is no further alternative. Therefore that, to which the alternative *be* or *not-be* does not apply, is *necessary*.

This means: **The *origin of everything* is necessary, and with it that what emanates from it, that is: being.**

Because if there were nothing, then also the *origin of everything* would **not exist**, and this was ruled out just before.⁶¹

This is the answer to the *first* of all questions, to the question: *Why is there anything and not nothing?*

⁶⁰ A "logical" condition of an object represents something which is *logically* necessary for its existence. But an "ontological" condition of an object is something from which the object has *actually* originated. In the reality, that, which an entity consists of, is always the ontological precondition of this entity.

⁶¹ Would this be simply a *logical* conclusion of the usual kind, then the contradiction could still be eliminated by the assumption that the *origin of everything* does not exist: if a contradictory object disappears, then also the contradictions linked with it disappear. In the case of the *origin of everything*, however – which is no object! – this conclusion is ontologically inadmissible. As follows:

Let A be the assumption that nothing exists. Let B be the assumption that the ontological status of the *origin of everything* is non-existence. Then A and B are identical. But since B is ontologically wrong, A must be ontologically wrong too.

Explanations, Additions

Actually existing things are always *active*, thought or described things are *passive*.

Real things consist therefore of substance *and* accidents, described things *only* of accidents. Although in the description the *kind of activity* of a thing can be displayed through its attributes, the *activity itself* is still lacking.

Since only the real things possess substance, their activity must stem from the substance; Substance must be that what makes the real things active.

Activity, however, cannot be an accident. Therefore, I call *activity* a *metaphysical quality*.

On actually existing objects, the substance is thus not only the precondition for their existence, but, at the same time, also that, from which the *activity* of the object comes, that, what drives the respective accidents.

So we can state: *Substance* is the *origin of everything*. It is *necessary*, and it is *activity*.

In itself, the *origin of everything* is pure substance – it does not divide into substance and accident. Since we cannot think the substance alone, the *origin of everything* cannot be thought as it is *in itself*.

If one still tries to grasp it mentally, then one gets beyond the limit of thinking, and then contradictions occur. These contradictions are unavoidable and prove therefore that there is an insurmountable difference between reality and our thinking. However this difference can be determined conceptually, and this makes it possible to draw conclusions. The first conclusion was that the *origin of everything* does neither exist nor not-exist and is therefore necessary. The second conclusion was that it is *activity*. Further conclusions will follow.

What is the *origin of everything for us*? Since we can only think within the scheme of substance and accident, we must also think the *origin of everything* in this way. This means: we must assign to it the metaphysical quality activity *as accident*, i.e. think of it as *something that* is active. However, since *in itself* it is *inseparably* linked with activity – so that activity is an essential element of its ontological status –, it seems to disappear if activity is separated from it. Therefore, *for us*, the *origin of everything* at first appears as *activity of nothing* – where, however, it is immediately evident that that which here appears as *nothing* cannot simply be identified with the purely conceptual nothing, because it would be nonsensical to assign activity to the purely conceptual nothing. Thus I shall denominate it AGENT.

Therefore, AGENT is that which disappears if one tries to think it, but of which is known at the same time that it cannot be nothing.

At first, all these conclusions appear strange because they lead an a priori condition of our thinking to a contradiction.

If contradictions follow from certain conditions, then usually this means that the conditions contain errors. However, here it is an *a priori* thought structure which proves to be wrong – so to speak: thinking cancels itself out. Thus one is confronted not with just a logical contradiction but with a limit of thinking. Therefore, from the contradiction a conclusion can, no: *must* be drawn that leads out of the realm of the thinkable: by deducing what is *not* the case – what the *origin of everything is not* – one arrives at *necessity* as its ontological status.

To make the matter a little more familiar, I will now try to present it again, however in a slightly different form.

For us it is impossible to think *existence* other than consisting of substance and accidents. Thinking originates from experiences on perceptible objects. Therefore, the substance-accident scheme appears self-evident in the case of a perceptible object: as answer to the question: "*From what* do the effects emanate?" it seems to be sufficient to *point to* the object. Only if one tries to follow the scheme to its limit, then it becomes clear that the notion "substance" – as it was defined here: as that which is carrier of attributes – cannot be thought without contradictions.

On the one hand the following applies: If one follows the logical *a priori* structure of notional thinking, then one remains only in the area of accidents. The fact that that, which is thought, *exists* has disappeared, or say: it is always presupposed.

Removing attributes means proceeding towards the General, and thus removing *all* attributes leads to the most General, the notion of pure being. But this notion is completely empty and therefore inappropriate to represent the carrier of attributes. So one gets – just as in mathematics – the answer *nothing*, and necessarily so, as mathematics represents the evolving of our thinking according to its own rules.

But if now, on the other hand, the fact of *existence* is taken into account, then it is immediately clear that this answer cannot be true, because, as mentioned above: nothing cannot bring forth any effects. Thus one arrives at a contradiction, if one tries to think the *origin of everything*. But since reality must be without contradictions, the occurrence of this contradiction can only mean that there is a fundamental, insurmountable limit of our thinking.

However this contradiction can be used: exactly for the reason that the *origin of everything* cannot be thought, we know something about it – namely that it does not divide into substance and accident, from which in turn follows that it does neither exist nor not-exist and is therefore necessary.

The scheme of substance and accident has its equivalent in the *subject-predicate structure* of possible statements about being. There is always a subject about *which* something is predicated, i.e. which does something or with which something is done. Thus the structure of language reflects the division of what being is *for us*: into that *from which* the effects emanate and the effects themselves. *For us*, this separateness is irrevocable – and yet we also recognize that it is actually impossible.

Of course one can ask, if the train of thoughts performed in this section relates indeed to anything real. There are several reasons for a positive answer:

1. If our thought train related to nothing real, then one would remain captured in the realm of the existing. This case has been discussed in the previous section: it leads to the assumption of elementary entities, which is tantamount to the assumption of *non-contingent being*, i.e. to the renunciation of any explanation of being. The thought train presented here is the only way out.

2. Without this thought train, one would again face the question: "*Why is there anything and not nothing?*" But the idea that this alternative could actually be there is outright absurd. It would be a scandal of reason if this question remained unanswered. The fundamental principle of the *completeness of reality* would be violated. However, the only possibility is to proceed beyond the alternative *be or not be*, because everything that exists is contingent, and only that which neither exists nor not-exists is *non-contingent* and therefore necessary.

3. Of course it is of decisive importance, whether it is possible to get from the *origin of everything* to being itself, i.e. if this formation process can be understood and formalized, and to what extent being can be derived from it.

More concretely, the question is, whether there is a path from where we are at the moment to the foundation of physics, and, if yes, what the advantage of this new substantiation of physics would be.

That will be decided in the following.

(An overview of the thoughts on the *origin of everything* can be found [in the summary](#) at the end of the book.)

Minimal Positive Metaphysics

If one aims to advance to the essence of being on the path of progressing abstraction, on the "via abstractionis", as has been attempted time and again in the philosophy since Plato and Aristotle, then one gets over ever-higher levels of generality at last to the most General with nothing in hand.

Although one can denominate this most General, e.g. one can call it "God" or "the Absolute" or "pure being", its concept is actually completely empty, and nothing can be said about it.

Not least it is this insight which has led to the prevailing conviction that metaphysics is impossible.

However, if one does not proceed on this path to the *most General* – which belongs to the realm of thought and of descriptions – but on the path to the *most Elementary* – which lies in the realm of the really existing objects – by continually asking what the things are actually made of, until one reaches an indivisible entity, then one recognizes that the concept of that what this entity is made of is not empty as the concept of the most General, but that the following logical and ontological conclusions are possible:

At first it can be understood very clearly that that what the things are *ultimately* made of, the *substance*, cannot be something which *exists*: existence is always substance *and* accident; The earth exerts *always* gravitation, it is there only *with* gravitation, without gravitation it does not exist. Substance alone does not exist, accident alone does not exist. In the concept of existence, both are inextricably united.

Therefore, for an answer to the question of what the substance is, one must leave the realm of the *Existing* and, at the same time, the realm of the *Thinkable*, and this fact in turn leads to the insight that that what everything consists of must be something whose *ontological status* is neither existence nor non-existence, but *necessity*.

Additionally, it proves imperative to assign *activity* to it, because existing objects, contrary to thought objects, are *active*, and this activity can only stem from that which the existing things are made of – in contrast to the thought things, which are in fact made of nothing.

I repeat these conclusions in order to make as clear as possible what the difference is between the metaphysics presented here and former (unsuccessful) attempts to derive positive metaphysical statements (i.e. statements with a specific content).

That, at which one ultimately arrives by continually asking what the things consist of, the substance, is the *origin of everything*. The *origin of everything* cannot be thought as that what it "is". In this respect, the assertion of the impossibility of "positive" metaphysics is thus confirmed.

But at the same time it is also refuted by the following insight: The *origin of everything* cannot simply be *nothing*, because the things – exactly for the reason that they are *active* – cannot consist of nothing, since nothing is not *active*, and from this follows that, though the *origin of everything* can indeed not be thought, it is still possible to know something **about it**, i.e. precisely these two conclusions:

The *origin of everything* is **necessary**, and it is **active**.

Thus on this path one arrives yet at a positive metaphysics, and it will turn out that it is exactly this "minimal" metaphysics which physics needs in order to substantiate its propositions.

In the following sections of this chapter will be shown that these two conclusions are necessary and sufficient conditions for the derivation of a law that forms the basis of the universe – a universe, that is, which organizes itself through flows and waves.

In the following chapters of the Second Part will be proven that from this law some of the most important physical theories and hypotheses can be deduced, and, moreover, in all cases in such a way that the underlying mechanism can be understood. Thus the *origin of everything*, seen as that which is *necessary* and *active*, is exactly that "principle of such general validity and at the same time of such important content that it can serve as sufficient fundament for the exact sciences".⁶²

The "minimal positive metaphysics" which has been derived here forms the necessary ontological basis of physics, in the sense that all "Why" and "What is" questions can be traced back to it. As long as such a basis is lacking, all these questions must remain unanswered – as has indeed been the case until now.

Starting from this ontological fundament, the mental reconstruction of the genesis of reality has to go in two directions: on the one hand, its regularities, the *natural laws*, must be derived – this will be done in the following –, on the other hand, the *formation of structures* must be substantiated – this will be subject of the Fourth Chapter of the Third Part.

⁶² Max Planck: Sinn und Grenzen der exakten Wissenschaft. Leipzig 1947, Johann Ambrosius Barth Verlag, zweite verbesserte Auflage, Seite 4

The Connection with the First Part

At the end of the First Part, I said:

"The universe can be understood analogously to an oscillating body, which organizes itself into wave patterns.

But it is just an analogy, and it will be replaced by a more abstract concept in the Second Part."

This "more abstract concept" has just been determined: it is not a body that organizes itself but *that which neither is nor is not, the origin of everything.*

1.4. What is that which exists? – The first Proposition; The first Equation

Our intention is to use the hitherto reached conclusions as basis for a description of reality. For this purpose, that, what we know about the *origin of everything*, must be brought into the form of a statement.

Starting point must be what the *origin of everything* is *for us*. This has already been defined as follows:

For us, the origin of everything is *activity* of AGENT.

(Here, however, it should be noted that by this act of *objectification* the difference to what the *origin of everything* is *in itself* is *not* removed: *in itself*, it does not divide into *substance and accident*. More on this unresolvable difference and its consequences will follow in the Third Part.)

Activity involves *change*. If nothing changed, it would be absurd to speak of activity.

With this, we have arrived at our first subject and first predicate:

The *first subject* is AGENT. The first *predicate* is *change*.

What changes? Since, in our thought train, we are still *before* any existence – though we have just brought the *origin of everything* into the form of something existing, it is still true that it neither exists nor not-exists – the change can only affect AGENT itself.

So we start with a change of AGENT on itself. If nothing followed from this change, then the predicate would disappear, and there would again be just nothing, in contradiction to the necessity of the *origin of everything*.

Thus something must follow from the change, and what follows must again be a change of AGENT on itself.

Therefore, the first statement appears at first in the form:

From one change follows another change.

However only if the reverse is also true – which means: only if the first change follows from the second one too –, then the perpetual chain of changes is generated which is necessary to avoid that there would again be nothing. From this follows:

One change is equal to another change.

The next step is to bring this statement into a mathematical form. It appears appropriate to express the changes by differential quotients.⁶³

Thus the *simplest* mathematical form of the first statement reads as follows:

$$\boxed{\frac{d\sigma}{dA} = \pm \frac{d\zeta}{dB}} \quad (0)$$

– where at first nothing is said about the kinds of changes. Also the space, which is necessary for establishing equation (0), is not determined. It is sufficient to postulate that it permits all operations that must be performed in the following.

Why is only the simplest mathematical form allowed?

Because our goal is to bring the necessity of the origin of everything *in itself* into the form which it must have *for us*. For this reason, the fundamental statement and also the fundamental equation can only contain what is necessary – in the sense that without it there would be nothing, which we have

⁶³ A more precise derivation of the first equation – with extensive substantiations of all steps – can be found at the beginning of the Third Part.

ruled out previously. Necessary, however, is only the simplest form of the equation. Any further addition could not be justified.

How are the variables in (0) to be understood? What are these variables?

Since it is proven that there is not nothing, we can presuppose everything that is a necessary condition for existence (would any of these conditions be missing, then would be nothing).

Existence needs in any case *spatial extension*. (No extension is tantamount to *non-existence*; then equation (0) couldn't even be established.)

Thus, the differentials in the denominator can be interpreted as length differentials

$$\text{Therefore} \quad \frac{d\sigma}{dr} = \pm \frac{d\zeta}{ds} \quad (0')$$

– where r and s have the dimension *length*. σ and ζ are dimensionless.

Another necessary condition of existence is *motion*. Without motion, everything would remain the same and therefore nothing would exist.

So the question is: How can equation (0') be transformed into a dynamical equation?

The *simplest* way is the following one:

We set $\zeta = v/c$ and $s = ct$, where v and c have the dimension *velocity*; v is the variable, c is a constant.

$$\text{This leads to} \quad \frac{d\sigma}{dr} = \pm \frac{d\frac{v}{c}}{d(ct)} \quad (0'')$$

and finally

$$\boxed{\frac{d\sigma}{dr} = \pm \frac{1}{c^2} \frac{dv}{dt}} \quad (1)$$

So **this is the law, from which reality is woven**, or, in other words, *the fundamental equation*, where fundamental means that everything can be derived from it, which is derivable at all. (The interpretation of σ follows below.)

What moves at velocity v ? AGENT. v is the flow of AGENT.

With this, the question is answered what being is:

Everything that exists is a pattern of changes of the flow of AGENT.⁶⁴

The empty notion AGENT, however, has now, due to the objectifying act of ascribing an attribute to it and by the conclusions that follow from that, turned into a *spacetime continuum*. Or, to say it more precisely: the *origin of everything* has – due to the act by which we have made it thinkable *for us* – become a continuum, the law of which is represented by equation (1).

With equation (1), also the first natural constant has appeared: the velocity c ; c^2 is the proportionality constant in the relation between the alteration of σ and the alteration of v . However it is clear that the magnitude of c can be *freely chosen* and does not have to be substantiated, because the process that *generates* reality contains c , which means that reality is derived from c and not c from reality. As indicated by the choice of the letter, c will be identified with the speed of light.

Now to the interpretation of σ .

I call σ *metric density*. What this means shall at first be demonstrated by an example:

Let r be a one-dimensional continuum.

Let A, B and C be three points of this continuum; the distances between A and B and between B and C be equal to 1.

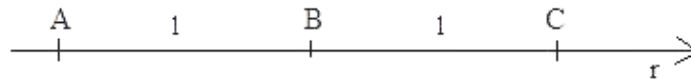

(S1)

⁶⁴ As definition, however, this applies to more complex forms of being only if their accidents are reducible. Further details on this restriction will follow in the Third Part.

Here, σ is constant. Now we change the conditions in the following way:

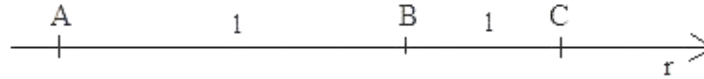

(S2)

The distances are still 1, but the length of the scale has increased between A and B, and between B and C it has decreased. This means, the *metric density* σ between B and C is greater than between A and B.

For the moment, this intuitive definition of σ is sufficient. The exact definition will be given below, in the description of gravity.

What follows in (S2) with respect of B? According to (1), a continuum flow must occur, which I call ***metric flow***, i.e. B is accelerated. The direction of the acceleration depends on the sign of the right term in (1). For the moment, we follow the idea that B is accelerated back towards the medium point between A and C. (Later, the other case will appear just by itself.) This means that in (1) the negative sign must be chosen:

$$\boxed{\frac{d\sigma}{dr} = - \frac{1}{c^2} \frac{dv}{dt}} \quad (1')$$

Important is the difference between the metric density σ and the "normal" density ρ : In the case of ρ , there is a definite value ρ_0 so that the magnitude of the acceleration depends on the magnitude of the deviation from this value. Thus here an *absolute* scale exists; ρ has a *memory*.

So if (S2) depicted a change of the normal density, then the magnitude of the density change would depend on the initial value of ρ . In order to eliminate this dependency, instead of (1') would have to be set

$$\frac{d\rho}{dr} \frac{1}{\rho} = - \frac{1}{c^2} \frac{dv}{dt}$$

In contrast, the metric density σ cannot have such an absolute value – it would be nonsensical to attribute an (absolute) density to the continuum. Thus here exists no absolute scale, and the term $1/\sigma$ can be dispensed with.

Therefore we can state: the continuum has *no density*; σ has *no memory*. (This is the reason why differential quotients *must* be used: every alteration can only depend on the preceding instant.) There is no absolute metric density, only density relations. From this follows in turn that there is no absolute size, only size relations.

Up to now, we discussed only a change of velocity that depends on the change of the *length scale*, which was illustrated by the points A, B and C in (S1) and (S2). However, in the case of a continuum with at least two dimensions, there are also changes of the *angle scale*. Let us first look at the "undistorted" case:

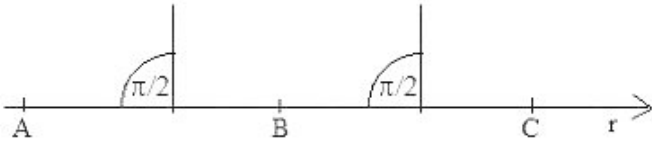

(S3)

The angle between the axis r and the direction of the second axis is constantly $\pi/2$. This holds true also in the next outline, however now the angle scale has changed in the following way:

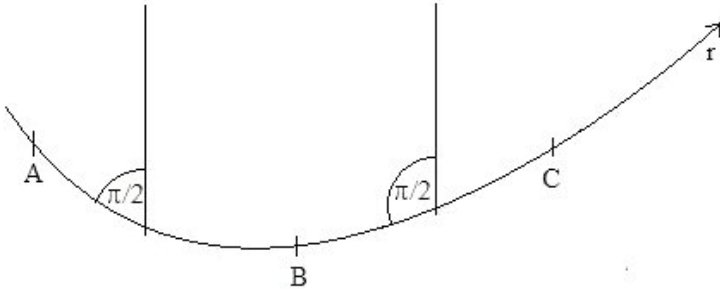

(S4)

Let η be an angle parameter analogously to σ , i.e. a *metric angle density*. In (S4), this angle density decreases with increasing r .

$$\frac{dv}{dr} = - \frac{d\rho}{dt} \frac{1}{\rho} \quad (\text{here, } \frac{d\rho}{dt} \text{ is the total derivative})$$

The comparison⁶⁵ shows, that (1a) applies in general only if $\frac{d\sigma}{dt}$ is understood as total derivative. However we will differentiate σ only partially with respect to time. Therefore we must presuppose that the change of σ along r is negligible, and that, accordingly, the total derivative $\frac{d\sigma}{dt}$, which contains also a dependency of r ($\frac{d\sigma}{dt} = \frac{\partial\sigma}{\partial t} + \frac{\partial\sigma}{\partial r} \frac{dr}{dt}$), can be replaced by the partial derivative $\frac{\partial\sigma}{\partial t}$.

So we look at the case $\sigma(r) = \text{constant}$ and start with a local change of σ or v . The following process will then be determined only by this first disturbance (and not by an already existing r -dependency of σ), in other words: by the equations (1') and (1a):

$$\frac{\partial\sigma}{\partial r} = - \frac{1}{c^2} \frac{\partial v}{\partial t} \quad (1')$$

$$\frac{\partial v}{\partial r} = - \frac{\partial\sigma}{\partial t} \quad (1a)$$

Differentiating (1') with respect to t leads to $\frac{\partial^2\sigma}{\partial r\partial t} = - \frac{1}{c^2} \frac{\partial^2 v}{\partial t^2}$

Differentiating (1a) with respect to r gives $\frac{\partial^2 v}{\partial r^2} = - \frac{\partial^2\sigma}{\partial r\partial t}$

⁶⁵ Also here, the term $1/\rho$ appears due to the fact that the magnitude of the change of the density depends on the deviation from an absolute standard value. In the case of σ , there is no such absolute scale but only relative changes, and therefore this term is again superfluous.

From this follows
$$\boxed{\frac{\partial^2 v}{\partial r^2} = \frac{1}{c^2} \frac{\partial^2 v}{\partial t^2}} \quad (3)$$

Thus we get waves in v , the velocity of which is c .

Following the same pattern, we get also waves in w :

From the equation
$$\frac{\partial \eta}{\partial r} = - \frac{1}{c^2} \frac{\partial w}{\partial t} \quad (2)$$

follows
$$\frac{\partial w}{\partial r} = - \frac{\partial \eta}{\partial t} \quad (2a)$$

and this leads to the wave equation

$$\boxed{\frac{\partial^2 w}{\partial r^2} = \frac{1}{c^2} \frac{\partial^2 w}{\partial t^2}} \quad (4)$$

Due to the symmetry of the equations (1') and (1a) with respect to σ und v , and also of the equations (2) and (2a) with respect to η and w , we obtain analogously also *metric waves*:

In σ :
$$\boxed{\frac{\partial^2 \sigma}{\partial r^2} = \frac{1}{c^2} \frac{\partial^2 \sigma}{\partial t^2}} \quad (5)$$

And also in η :
$$\boxed{\frac{\partial^2 \eta}{\partial r^2} = \frac{1}{c^2} \frac{\partial^2 \eta}{\partial t^2}} \quad (6)$$

It should be noted that all these waves are waves within the longitudinal flow. With respect to the waves in σ and v , this follows from the fact that equation (1a) applies only to a length element in the flow itself.

Regarding equations (2) and (2a) – which relate to the transversal flow w – the following can be stated: if there is a longitudinal flow $\neq 0$ along r , then the relations described by these equations – and thus also the waves in η and w – apply to systems that are moving with the flow.

What are these waves?

The question arises, what the relation is between the waves just derived and waves of standard-physics.

Since we identify c with light speed and, accordingly, all waves travel at light speed, they must be related to electromagnetic or gravitational waves.

For the moment, however, such a relation is not in sight.

1.6. Notes

Short Summary

First, a brief sketch of the previous train of thought.

Being is not reduced to elementary entities but to *that what neither exists nor not-exists* and what is therefore *necessary*.

This is the *origin of everything*. It is inseparably bound to *change*. In order to make it *thinkable*, change must be ascribed to it *as attribute*.

As *that which* changes, it can then become the basic concept of the description of everything.

Change can be concretized on the basis of the necessary conditions of existence, which means: the quantities that change can be determined. This leads to the first physical law (1).

In this law, *length (or angle) scale* and *motion* are put into a mutual relationship, such that a change of scale leads to a change of motion and vice versa.

The differential law (1) weaves a continuum of flows and waves. From the differential scale the *metric* emerges, and the differential changes of motion result in the *metric flow*. In the flow there are *metric waves*.

Thus with the few hitherto taken steps we have arrived at a concept of a universe, which organizes itself in the form of flows and waves.

Relativity

Though equation (1) is not relativistic in the usual sense, it is still appropriate as basis for special relativity, as it contains only the time-dependent change of the velocity v . The absolute value of v has no relevance.

If one starts with equation (0'):

$$\frac{d\sigma}{dr} = \pm \frac{d\zeta}{ds}$$

and replaces s by ct , then follows

$$\frac{d\sigma}{dr} = \pm \frac{d\zeta}{d(ct)}$$

σ was interpreted as metric density. Therefore, in this equation, two metric densities are put into relation: a *spatial* density (the density of the r -axis or, alternatively, the angle density along r) and a *temporal* density (the density of the ct -axis).

If this equation is compared with (0'')

$$\frac{d\sigma}{dr} = \pm \frac{d \frac{v}{c}}{d(ct)}$$

then can be seen that the ratio of v and c represents the metric density of the time-axis.

Combined with the previous statement, this means that the metric flow v contains the total metric information, i.e. the information, how lengths and times vary depending on the flow.

Of particular importance is that the concept established at the beginning – the *origin of everything* – is appropriate to solve the conceptual problems which exist since the introduction of the theory of relativity.

They have been mentioned already in the chapter on relativity in the First Part. It is the questions: *What oscillates in light waves?* and: *What mediates the temporal connections between systems located arbitrarily far from each other?* The absolute system (ether) does not exist anymore, only coordinate systems – but they *do not exist* and can therefore not mediate anything.

Thus one faces the paradoxical fact that although light exists *as a wave*, there is still nothing *which* oscillates. If there were an area of reality where there would be nothing but light, and then the light were removed, literally *nothing* would exist.

This, however, corresponds exactly to that which applies to the *origin of everything*: it is defined as *change* of AGENT – it exists *for us* only *as changing*, whereas *without change* it disappears.

In itself it is unthinkable: it does not divide into substance and accident. But it is inseparably bound to change. It is only there *as change*.

By ascribing change *as attribute* to it in order to turn it into the subject of a statement, we generate a paradox, because now we must think it also *without change*, and this is an inadmissible thought.

This means: the "undistorted" continuum of the special theory of relativity is an *idealization*, however in a much stronger sense than the notion "idealization" is commonly used: the undistorted continuum does not just represent a state which is never realized in nature, but rather a state, in which the respective area of reality would simply *not exist*.

In short: the undistorted continuum of the special theory of relativity does not exist. Reality is always change, and, as the equations hitherto established show, *metric change*.

Even shorter: though there is an oscillation, there is still nothing that oscillates.

(It should be mentioned that, in the First Part, the relativistic space time measures have been derived from the assumption that everything which exists must be understood as superposition of waves with light speed.)

So is there an absolute system?

Yes. But it is no ether, nothing "within" space, also not space itself, and no quantum vacuum. It is even not a reference system in the sense of special relativity.

Rather it is – as will be shown in the next chapter – a system of *accelerated metric flows*.

These flows occupy the whole universe – or, to put it correctly, they *are* the whole universe. Within them, time does not change and passes faster than in any local reference system that moves relative to the local metric flow.⁶⁶

Thus special relativity is a pure description tool, which is justified only if the metric circumstances are in sufficient approximation identical with Euclidean metric. Ontologically, however, the undistorted continuum *does not exist*. What exists is a continuum in permanent metric change, and in such a continuum indeed exists an absolute system.

Thus the ontological status of a metric continuum can – a little inaccurately – be seen as positioned *between* existence and non-existence: If nothing changes, nothing exists, but if there are changes, then they will, as described by the equations (1) and (2), be transported, so to speak, from point to point – and ultimately they will form a continuum that consists purely of *metric changes* and in which metric circumstances are connected with each other over arbitrary great distances.

With this, the conceptual paradoxes of the relativity of motion are completely cleared up.

As could be seen, for the explanation it was necessary to step out of the realm of physics. The paradoxes cannot be solved by physical concepts. Thus physics requires metaphysics; otherwise it would remain incomplete.

The results of this chapter prove the hypothesis that has been established in the First Part: *There is nothing but light speed*.

⁶⁶ This applies only to a universe without antimatter. More on that follows in chapter three "antimatter".

Now, however, the image is more complete, because now also the law is known which the waves are based upon, and because there are not only metric waves but also metric flows. But that had to be expected, since any local change, the periodic form of which can propagate wave-like, must also exist in a non-periodic form.

The Role of Mathematics

I take the assertion that "the undistorted continuum does not exist" as an opportunity to briefly discuss the ontological status of mathematics at this point of our trains of thought.

This assertion itself is definitely non-mathematical. It is an ontological assertion about a mathematically defined state – and this exemplifies precisely the relation in which mathematics and ontology stand here in general: the fundamental relation (1) is not brought forth by mathematics; indeed the reverse is true. As follows:

As will be shown subsequently, the fundamental law creates stationary states, i.e. spacetime patterns that can be understood as objects. These objects can be counted and measured.

Counting and measuring, however, are the beginning of mathematics, which therefore, just as logic, owes its existence to experiences with objects.

Mathematics is based on – and develops from – that what reality is *for us*: relations between objects.

But reality *in itself* is continuous change. Therefore, description and reality touch one another only if the analysis, coming from counting objects, has finally – by successive definition of new kinds of numbers – captured the world of the infinitely small; only there, in the form of the differential quotient, thought as result of an unlimited process of size reduction, mathematics and reality *in itself* meet one another.

So we find ourselves in an epistemological circle. In order to describe the *origin of everything*, we must presuppose mathematics. However only in the description mathematics comes before the fundamental relation, in the reality the opposite is true: the fundamental relation is not only the origin of everything that exists but also the origin of mathematics.

In the Third Part I will discuss this issue in more detail. However it seemed important to me to outline the basic facts already here, because the role of mathematics is changed by these facts; at the

beginning, not mathematics but ontology has the final word, and at first it is even unclear whether and how far mathematical concepts – which, as just mentioned, originate in experiences on things – apply to circumstances that belong to a realm which lies logically and ontologically *before* the appearance of objects.

Scale and Motion

The only quantities hitherto used are *length*, *angle* and *time*, the only variables are *metric length density*, *metric angle density* and *velocity*.

This will remain unchanged in the course of my presentation. The universe outlined here is a *metric dynamic* universe, where only the above quantities are considered fundamental. All other quantities are derivative.

This is also important for the reason that physical circumstances are only conceivable to us if they can be reduced to metric and motion. The reason of the *disappearance of reality* described in the First Part lies not least in the fact that all other physical quantities – as e.g. energy or mass – have completely lost their ontological meaning. All that remains is their mathematical definition.

Already in the First Part, the reduction of the quantities *energy and momentum* to the quantities *frequency and wave-length* has proven to be necessary for the realistic interpretation of the interaction between radiation and matter. For the realistic interpretation of quantum mechanics in general was then required to understand *all* observables as derived from wave-attributes.

Here, this program shall be continued and concretized by the explicit derivation of physical notions and laws from metric dynamic circumstances.

On the first Law

Finally it should be stated that equation (1) does *not* represent an interaction.

It follows from two facts:

1. There is no existence without change.

2. There cannot be nothing; existence is necessary.

Therefore, equation (1) expresses exactly what the *origin of everything is for us*, i.e. what is logically and ontologically presupposed for everything that exists.

This means that this equation comes *before* any interaction; it is positioned, so to speak, on a "deeper" ontological level. It is a necessary condition for the development of *metric patterns* – in the simplest case stationary states of the metric flow – which represent *objects*. Only the effects that these objects exert upon one another can then be understood as interactions.

If we now proceed to the description of interactions and structures, the following must always be kept in mind: Whatever exists, whatever happens – it is in any case *exclusively* the first law that executes itself. There is only this one law. Each causal connection stems from it. *Everything* is a consequence of the differential causal chains that are described by equation (1).

From this follows:

Structures can only develop through self-organization. If they exist over a certain period of time, then they must be regarded as *attractors* of the continuum dynamics.

Thus the concept "attractor" replaces the concept "particle" and becomes the ontological basis of the concept "object". It is of utmost generality: it is applicable to (almost) all beings, from the simplest to the most complex ones, from "elementary particles" up to "mental states", that is: *qualia*.

Also the processes that occur in *interactions* result directly from the execution of the first law – in this case, however, under the assumption of *additional order* which can be defined by metric conditions. Therefore also the interaction laws are a consequence of self-organization of the continuum: *they emerge together with the objects* and express their mutual influence.

In this Second Part of my work, I shall deal only with the simplest stationary states and specify their metric definitions. Hence gravitation, electromagnetism and atomic structure can be derived.

In the Third Part, however, the concept "attractor" and the conclusions connected with it will play a central role.

2. Gravitation⁶⁷

The program of this chapter is to demonstrate that the concepts *metric density* and *metric flow* permit an alternative view of gravitation, which can be understood as *basic mechanism of gravitation*. In the following, the spherically symmetric, stationary case will be examined; A simple metric assumption leads at first to predictions that are identical with the Newtonian approximation, and then – without additional assumptions, only through a more precise analysis of the scenario – also to predictions that match those of the theory of general relativity.

However, the view of gravitation changes completely, because in the metric dynamic universe there is no force as in the Newton model, no spacetime metric as in the Einstein model, and finally also no mass measured in Kilogram (or energy measured in Joule) as cause of gravitation, but only metric length-density and metric flow.

2.1. The metric-dynamic View of Newton's Approximation

We look at an n-dimensional continuum ($n > 1$). Let r be the distance of an arbitrary point P from a point O, which we choose as origin of our coordinate system. Let m be a given distance ($m > 0$).

We presuppose equation (1')
$$\frac{d\sigma}{dr} = - \frac{1}{c^2} \frac{dv}{dt}$$

The question is: How can the gravitation of a central mass resting in O be defined as a purely metric-dynamic phenomenon?

Our goal is to model a spherically symmetric, steady state, which is defined by the fact that the acceleration points in the direction of the center O, decreases with increasing distance from this center and becomes 0 at infinity. We achieve this through the following metric assumption:

$$\sigma = \frac{r - m}{r} \quad (\sigma \text{ is the metric density of the length}) \quad (7)$$

⁶⁷ In Section 2.5, the sketch (S9) and the according explanations are wrong. ([Here](#) is more to that.) For the correct versions see my paper [Against Dark Matter - A New Theory of Gravitation](#), which contains some important upgrades.

– where r is the distance PO *before* the metric change, $(r - m)$ the distance PO *after* the metric change⁶⁸

(7) differentiated with respect to r gives

$$\frac{d\sigma}{dr} = \frac{m}{r^2} \quad \text{According to (1')} \quad \frac{d\sigma}{dr} = -\frac{1}{c^2} \frac{dv}{dt}$$

follows
$$\boxed{\frac{dv}{dt} = -c^2 \frac{m}{r^2}} \quad (8)$$

If in (8) m is interpreted as *geometric mass* ($m = \frac{MG}{c^2}$)

then applies
$$\frac{dv}{dt} = -\frac{MG}{r^2} \quad (9)$$

Thus, equation (8) is the *Newtonian gravitational acceleration* in the case of a central mass M .⁶⁹

The cause of Newton's gravity is the force exerted by a central mass. **In the metric dynamic model, the mass M is replaced by a metric defect m ,** from which follows a change of the metric density, which in turn results in an acceleration towards the center.

What is actually accelerated? – Other than in Newton's model, here dv/dt in equation (8) or (9) is not an acceleration that acts on *objects*. Rather it is *the time-dependent change of the radial metric flow v : the continuum itself flows accelerated towards the center.*

We determine the size of this flow. First we must rearrange (1'):

$$\frac{d\sigma}{dr} = -\frac{1}{c^2} \frac{dv}{dt} \quad \rightarrow \quad d\sigma = -\frac{1}{c^2} \frac{dr}{dt} dv$$

⁶⁸ Details see Section 2.3. *The Transition to the Metric View.*

⁶⁹ According to equation (8), the gravitational acceleration is proportional to the metric defect m and to $1/r^2$. The proportionality constant is c^2 . This means: in the metric dynamic description of gravitation, there is no independent gravitational constant.

Since the continuum itself flows towards the center, $\frac{dr}{dt}$ must be understood as v , and then follows

$$d\sigma = -\frac{1}{c^2} v dv \quad (10)$$

Integration gives
$$\sigma = -\frac{1}{c^2} \frac{v^2}{2} + C$$

According to (7)
$$\sigma = \frac{r - m}{r}$$

follows
$$1 - \frac{m}{r} = -\frac{1}{c^2} \frac{v^2}{2} + C$$

The integration constant C follows from the condition $v = 0$ for $r \rightarrow \infty$.

Therefore
$$C = 1$$

Thus we get
$$\frac{v^2}{2} = c^2 \frac{m}{r}$$

and finally
$$\boxed{v = \pm c \sqrt{\frac{2m}{r}}} \quad (11)$$

(11) corresponds to Newton's equation for the gravitational velocity (in the case of a fall from infinity) at a geometric mass m ($m = MG/c^2$). Here, however, v is not interpreted as velocity of a falling object but as *velocity of the radial metric flow*. It must have the same direction as the acceleration in (8). Therefore, in (11) the negative sign must be chosen.

As is known from the considerations of 1.4 and 1.5, in the flow there are metric waves traveling with light speed relative to the flow.

Note: Actually, the wave equation (3) does not apply here, because σ depends on r . If the neighborhood of any point P , however, is chosen small enough, so that the metric correspond to a Euclidean metric with sufficient accuracy, then it can be asserted that in this neighborhood waves with the speed of light exist.

Now there are two possibilities; either we continue to look at the scenario from a Cartesian coordinate system – let us call it K – and additionally take into account that v is the velocity of the continuum flow, or we use a local system as starting point for the transformation to a relativistic reference system.

The second option we will discuss later. First, we turn to the first variant.

2.2. The exact View from outside; some simple Calculations

Let us pause for a moment to think about what we actually observe, and what position we take.

We look at the scenario from a non-relativistic Cartesian coordinate system K .

Since the waves with light speed which we observe are waves *in the flow*, the light speed is *not constant* with respect to K . E.g. light moving towards the center has the velocity $c + v$, and light moving in the opposite direction the velocity $c - v$.

So we are not observers who belong to the *real* scenario. K is *nothing but* a coordinate system, and we look at the metric flow where – as seen from us – waves with velocities $c + v$ and $c - v$ propagate, in the same way as we would look at a river where – as seen from the bank – waves move faster in the direction of the flow than waves that move against it.

Thus our point of view is not the usual relativistic observer viewpoint. We reside so to speak *outside* of the universe – and nothing can be objected against such a viewpoint, if something observable can be derived and if the return to an observer system is possible.

The change from the viewpoint of Section 2.1, where the Newtonian gravitational acceleration was derived purely formally, can be described as follows:

Now we take into account that the waves, which the acceleration acts upon, do not exist in the coordinate system K but *in the flow*. The metric continuum itself flows accelerated towards the center and disappears there like in a drain, and the waves with light speed flow with it.

However, as stated in the First Part, *everything that exists* is a pattern of superpositions of these waves. Thus there is nothing but these waves, and therefore the paths of objects must follow from the analysis of the paths of the waves with light speed within the accelerated flow – and the results must be *exact*, because the scenario is determined without the use of any approximations.⁷⁰

This shall now be demonstrated by some well-known examples.

As can be seen already at first glance, some phenomena are particularly easy to understand from our point of view:

E.g. from (11):
$$v = -c \sqrt{\frac{2m}{r}}$$

follows that at $r = 2m$ the velocity of the flow is equal to light speed. This means that at $r = 2m$ waves traveling with light speed against the direction of the flow cannot move outwards but are standing still. This is a particularly simple case of analyzing a light path!

Moreover, it is immediately clear that within a radius of $2m$ no static relativistic reference system can be established, since here is $v > c$. The light paths, however, can also in this area easily be analyzed.

We will now perform some calculations.

Closed circular Path of the Light

First we determine the distance from O where light propagates at a closed circular path. (This is already a significant test of our model, because the solution is located near the center, which means: in an area where approximations – e.g. the Newtonian approximation – differ greatly from GR.)

In order to determine this distance, we must factor in the shifting of the light rays by the flow.

(In the following, c is set equal to 1)

⁷⁰ In the approximation without the flow, the assumption that objects are wave superpositions has no consequences: it does not matter whether the acceleration acts on the waves or directly on the objects. However determining the object paths *in the flow* is only possible on the basis of this assumption, as will be shown in the following.

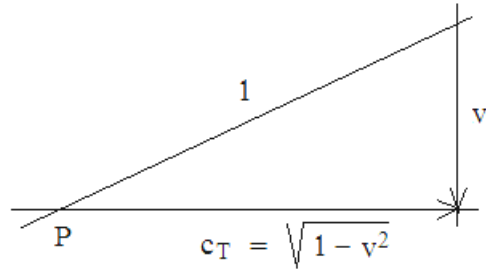

(S6)

v is the velocity of the flow, c_T is the tangential velocity of the light at a point P that lies on the sought circular path. (With respect to K , the speed of the light is changed due to the flow.)

According to (11), the absolute value of the flow is

$$|v| = \sqrt{\frac{2m}{r}}$$

According to (8), there is an acceleration field

$$\frac{dv}{dt} = -\frac{m}{r^2}$$

In a system *without flow*, the equilibrium condition for a circular path in the case of this acceleration is

$$\omega^2 r^3 = m \quad (\omega \text{ angular frequency})$$

From this follows $v_T = \omega r = \sqrt{\frac{m}{r}}$ (v_T absolute value of any tangential velocity)

Thus the equilibrium condition is

$$v_T = \sqrt{\frac{m}{r}} = |v| \frac{1}{\sqrt{2}} \quad (v \text{ flow velocity})$$

So we must find the distance r where the *flow-corrected* speed of the light c_T assumes this value of v_T .

$$\text{It holds that } c_T = \sqrt{1-v^2} = \sqrt{1-\frac{2m}{r}}$$

Therefore, taking into account the flow v , the equilibrium condition is

$$c_T = \sqrt{1-\frac{2m}{r}} = \sqrt{\frac{2m}{r}} \frac{1}{\sqrt{2}}$$

$$\text{From this follows } 1-\frac{2m}{r} = \frac{m}{r}$$

$$\text{and, finally } r = 3m$$

So we obtained the well-known result.

Perihelion Precession

The same scheme can be used for calculating the perihelion precession:

We start again with the equilibrium condition for a circular path:

$$v_T = \sqrt{\frac{m}{r}} \quad (v_T \text{ absolute value of the tangential velocity})$$

As before, due to the flow, the tangential velocity must be corrected. If v_T is reduced by the factor

$$k = \sqrt{1-v^2} = \sqrt{1-\frac{2m}{r}}$$

– then this reduced⁷¹ v_T is now – with respect to the acceleration field

$$\frac{dv}{dt} = -\frac{m}{r^2}$$

– *too slow* for a circular path. Thus we must move nearer to the center, i.e. we must find the distance r' , where v_T is increased by the factor $1/k$, so that at this distance the equilibrium condition is met again (with sufficient approximation).

So we set

$$\sqrt{\frac{m}{r}} \frac{1}{\sqrt{1 - \frac{2m}{r}}} = \sqrt{\frac{m}{r'}}$$

Then

$$\frac{m}{r} = \frac{m}{r'} \left(1 - \frac{2m}{r}\right)$$

This gives

$$r' = r - 2m.$$

Thus the equilibrium condition for the flow-corrected tangential velocity is met at the distance $r - 2m$.

Instead of $\omega^2 = \frac{m}{r^3}$ we must therefore set

$$\omega^2 = \frac{m}{(r - 2m)^3} = \frac{m}{r^3 \left(1 - \frac{2m}{r}\right)^3}$$

$$\omega^2 \approx \frac{m}{r^3} \left(1 + \frac{2m}{r}\right)^3 = \omega^2 \left(1 + \frac{2m}{r}\right)^3$$

⁷¹ Since *every* motion must be seen as composed of light paths (there is only light speed!), the correction factor remains the same in all cases. Always light paths are corrected; any $v < c$, which is not a flow velocity, must be understood as an interference phenomenon.

$$\omega' = \omega \left(1 + \frac{2m}{r}\right)^{\frac{3}{2}}$$

$$\frac{\omega'}{\omega} = \left(1 + \frac{2m}{r}\right)^{\frac{3}{2}} = 1 + \frac{3}{2} \frac{2m}{r} + \frac{3}{8} \left(\frac{2m}{r}\right)^2 + \dots \approx 1 + \frac{3m}{r}$$

The perihelion precession is therefore equal to $\frac{3m}{r}$, and this conforms to the result that follows from the theory of general relativity.

Light Deviation

Here, nothing at all must be calculated. The result can just be *seen*.

The Newtonian light deviation can be presupposed. Let the deviation angle be δ .

As before, the acceleration

$$\frac{dv}{dt} = -\frac{m}{r^2}$$

must be taken into account. According to our presupposition, it gives the angle δ . Then the shifting of the light rays by the flow must be factored in. However since the flow velocity

$$v = \sqrt{\frac{2m}{r}}$$

is equal to the fall velocity in the case of the Newtonian acceleration, it is evident that the displacement caused by the flow makes the same contribution to the deflection of the light as the acceleration..

Thus the deflection is twice as large as in the Newtonian approximation, which means it is equal to 2δ .

2.3. *The Transition to the Metric View*

As mentioned at the end of section 2.1, a local system S_F that moves with the flow can also serve as starting point for the transition to a relativistic observer system S_E . ("Local system" means: of such a small extent, that the length-differentials remain constant in sufficient approximation.)

The first step is to connect the scenario just created with the usual metric concepts used for the description of gravity.

For this purpose, we define σ as follows:

Let dr be the radial length differential of the "undistorted" continuum, dr' the length differential of the distorted gravitational continuum. Then we define

$$dr = dr' \sigma \quad \Leftrightarrow \quad \sigma = \frac{dr}{dr'} \quad (12)$$

With (7) $\sigma = \frac{r - m}{r}$ follows

$$\frac{dr}{dr'} = \frac{r - m}{r}$$

or
$$dr' = \left(1 - \frac{m}{r}\right)^{-1} dr \quad (13)$$

The following outline illustrates the metric conditions:

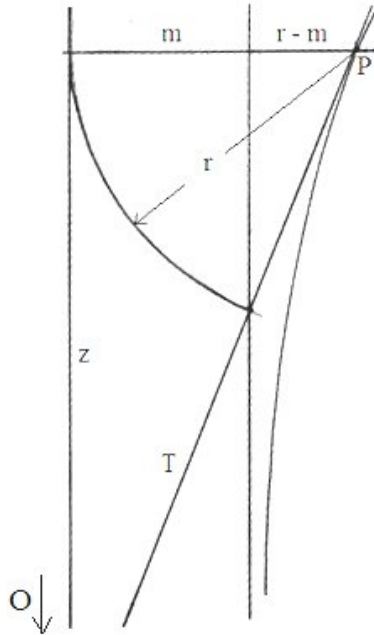

(S7)

z is the axis of the auxiliary dimension. P is a point on the curve that represents the altered radial measures (dr' corresponds to the length differential of the curve). T is the tangent at P .

As can be seen in the outline, it holds that $(r - m)/r = dr/dr' = \sigma$. (In the following, I will use dr_N instead of dr' .)

Thus we know at any point the slope dz/dr of the curve. Integration, however, is not possible – the curve lies "at infinity". However this is not relevant – the outline serves only for illustration.

In the multidimensional case it is – due to the spherical symmetry of the scenario – sufficient to describe the metric conditions on an arbitrary plane through O .

Let r and φ be polar coordinates:

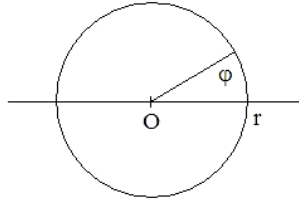

(S8)

Then the *non-relativistic* system S_N , that represents the metric conditions of the continuum in the case of a central geometric mass m , is characterized by

$$S_N: (dt_N = dt, dr_N = (1 - \frac{m}{r})^{-1} dr, d\phi_N = d\phi) \quad (14)$$

Compared with an undistorted continuum, only the radial differential dr is changed. The time differential dt and the angle differential $d\phi$ remain identical.

Note: From the construction of the tangent in the outline (S8) follows that the point P, whose distance from z *before* the metric alteration is equal to r (with $r \geq m$), lies – with respect to the length scale dr_N that applies in P *after* the alteration – at the distance $r - m$. This holds true for all P, also for those that lie arbitrarily close to the intersection of the curve with the r -axis. Therefore it can be stated:⁷²

$$r_N = r - m$$

Seen in this way, the S_N -continuum lacks m length-units at any direction from O. According to (7), σ represents the ratio between the distance PO *after* the alteration and the same distance *before* the alteration (measured with the scales that apply in the respective system):

$$\sigma = \frac{r - m}{r} = \frac{r_N}{r} \quad (15)$$

⁷² One could also simply imagine moving from P along the curve up to the r -axis. Then one has, measured by dr_N , covered the distance $r - m$. At the point where one arrives at the end, dr_N/dr will be infinite, which means, the differential dr_N is no longer infinitely small but finite, and accordingly the distance to the center measured by it will be zero. Thus the total distance between P and the center O amounts to $r - m$. (A bit more on that issue will follow in the subsection "The Area $r < m$ ".)

This permits an alternative definition of the metric of S_N :

$$\frac{dr}{dr_N} = \frac{r - m}{r} \quad \Leftrightarrow \quad \frac{dr}{dr_N} = \frac{r_N}{r} \quad (16)$$

The hitherto used description of gravity is *non-relativistic*. Thus there are no alterations of lengths and times due to a relative movement. Therefore, what has been said about the measures of the system S_N that rests relative to O holds also true for a (local) system that moves with the flow.

2.4. The Transition to Einstein's Gravity: The Schwarzschild-metric

Now we will perform the transition to a relativistic reference system S_E that rests with respect to O.

Since the flow velocity is known, it would be possible to transform from a local *relativistic* reference system S_F that moves with the flow to a local relativistic system S_E that rests relative to O. For this purpose, however, the length of the differential dr_F of S_F is required. How can dr_F be determined?

The radial differential of the Newtonian reference system S_N is known. Here, the description is non-relativistic, and therefore this differential is equal to the differential of a local *non-relativistic* system S_{F_0} within the flow, where the (local) light speed is nonetheless *constant*.

$$\text{Thus, according to (14)} \quad dr_{F_0} = \left(\frac{r - m}{r} \right)^{-1} dr \quad (16')$$

$$\text{and, after (16)} \quad dr_{F_0} = \left(\frac{r_{F_0}}{r} \right)^{-1} dr \quad (16'')$$

According to this definition, the metric is determined only by *one single factor*: by the quotient of the radial distances *without* gravity (r) and *with* gravity ($r - m$ or r_{F_0}).

Thus now we have to ask: How does this factor change at the transition from the non-relativistic to the relativistic flow-system? If the distance of a point P from O with respect to S_{F_0} is equal to $r - m$, what is then the distance PO with respect to the *relativistic* flow-system S_F ?

This can be answered in the simplest way as follows. The velocity of the flow is

$$v = -c \sqrt{\frac{2m}{r}}$$

At the distance $2m$, the flow reaches light speed. Thus at this distance, any finite radial distance of the resting system – as seen from the flow system – becomes zero, such that any point, which lies at the distance $2m$ from O , will have – seen from the flowing, relativistic continuum – the distance zero. With this, for any point at a distance r with $r \geq m$, the distance from O has decreased by $2m$. Therefore, in the relativistic view, the continuum does not lack m but $2m$ units at any direction from O .

Thus, at the transition from S_{F_0} to S_F , in the factor by which the metric is defined the quantity m has to be replaced by $2m$. (This change affects only the length differential, the time- and angle- differential remain unchanged.) Therefore it holds that

$$dr_F = \left(\frac{r - 2m}{r} \right)^{-1} dr \quad (17)$$

Can we actually dispose of the radial length differential in this way? Would not the velocity and acceleration of the flow have to change?

No. v and dv/dt were determined without relating to the metric conditions in the flow. They followed from the basic equation (1')

$$\frac{d\sigma}{dr} = - \frac{1}{c^2} \frac{dv}{dt} \quad \text{and from (14)} \quad \sigma = \frac{r - m}{r}$$

Only by the definition (12)

$$\sigma = \frac{dr}{dr'}$$

the connection between metric conditions and velocity or acceleration was introduced. This definition of σ , however, must be abandoned after the transition to a relativistic view. In a relativistic reference system, σ is no longer a metric density.

According to (17), a local system S_F within the flow is characterized by

$$S_F: (dt_F = dt, dr_F = (1 - \frac{2m}{r})^{-1} dr, d\phi_F = d\phi) \quad (18)$$

(As before, only the radial differential is changed.)

Now we can (for any r with $r > 2m$) transform to a local system that rests relative to O .

This can simply be carried out by multiplying the length differential and the time differential of S_F with the factor k of the Lorentz transformation ($k = \sqrt{1 - \frac{v^2}{c^2}}$).⁷³

According to (16) $v = \pm c \sqrt{\frac{2m}{r}}$

applies $k = \sqrt{1 - \frac{v^2}{c^2}} = \sqrt{1 - \frac{2m}{r}}$ (19)

Then the radial length differential dr_E of S_E is

$$dr_E = dr_F k = dr (1 - \frac{2m}{r})^{-1} (1 - \frac{2m}{r})^{\frac{1}{2}} = dr (1 - \frac{2m}{r})^{-\frac{1}{2}}$$

And the time differential dt_E is

$$dt_E = dt (1 - \frac{2m}{r})^{\frac{1}{2}} \quad (\text{note } dt_F = dt)$$

⁷³ Even if the Lorentz transformation were not known from standard physics, it could be presupposed here, since in the First Part – in the chapter on relativity – it was shown that it follows from the assumption: *everything which exists and which happens is an interference phenomenon, a pattern of superpositions of waves with light speed.*

The totality of these local systems represents the Schwarzschild metric:

$$ds^2 = \left(1 - \frac{2m}{r}\right) dt^2 - \left(1 - \frac{2m}{r}\right)^{-1} dr^2 - r^2 d\phi^2 \quad (20)$$

(20) applies to any plane through O.

$r d\phi$ remains again unchanged. The perimeters have never been altered.

2.5. Summary, Additions

The results of the previous sections justify the following assertion:

In the metric dynamic view, the gravitational field of a central geometric mass m ($m = MG/c^2$) is a spherically symmetric steady state, which is defined by an accelerated radial metric flow $v(r)$ towards the center

The velocity of the flow is

$$v = -\sqrt{\frac{2m}{r}}$$

The acceleration is

$$\frac{dv}{dt} = -\frac{m}{r^2} \quad (m \text{ geometric mass, } c = 1)$$

The cause of the flow is a metric change: the continuum lacks m units in all directions from the center, i.e. every radial distance – measured with the scales of the system – is by m units smaller than in the undistorted continuum.

Within the accelerated flow there are waves with light speed. The paths of objects can be determined on the basis of the hypothesis that all objects are superpositions of such waves.

(This method has been demonstrated here using the example of the perihelion precession.)

Gravity defined in this way leads in the spherically symmetric case to results that match those of the general relativity theory. From the metric of the local non-relativistic reference systems within the flow, the metric of the local relativistic reference systems can be derived. The totality of these local systems represents the Schwarzschild metric.

It is not likely, however, that the congruence with the results of the general relativity theory is limited to the spherically symmetrical case.

Thus we define:

Gravity is the generic term of all dynamic phenomena which can be attributed to the longitudinal metric flow v that results from equation (1'):

$$\frac{d\sigma}{dr} = - \frac{1}{c^2} \frac{dv}{dt}$$

From this follows that the waves of the equations (3) and (5)

$$\frac{\partial^2 v}{\partial r^2} = \frac{1}{c^2} \frac{\partial^2 v}{\partial t^2} \qquad \frac{\partial^2 \sigma}{\partial r^2} = \frac{1}{c^2} \frac{\partial^2 \sigma}{\partial t^2}$$

are *gravitational waves*.

This assertion seems at first strange, especially because of the restriction to changes of the *longitudinal* metric flow. It should be noted, however, that the above wave equations have such a simple form only due to two reasons: *first* they describe waves that propagate *with* the flow, and *second* they are not valid with respect to a relativistic reference system but with respect to a *non-relativistic* reference system, so to speak as seen from outside of the universe.

The difference between the metric dynamic model and general relativity can be expressed in the following way:

In the general theory of relativity, there is a space time coordinate grid, and distortions of the grid lead in general to a change of all components; length and angle changes are not separable.

In the flow model, there is not a space time coordinate grid but only a spatial flow consisting of *flow lines*. In the flow, time never changes. In the spherically symmetric case, the flow velocity corresponds – as has been shown – to the Newtonian fall speed (at the fall from infinity). The only other variable is the metric density along the flow lines. This means: only the longitudinal metric changes are relevant; changes of the metric angle-density do not occur.

The universal Flow-Field

In the case that there is not only a single mass but many masses distributed over a metric structure (e.g. a universe) the following applies:

The acceleration field of any mass, i.e. the field which the flow velocity depends on, is *exactly* $-m/r^2$.

In order to determine the flow lines, first the points must be located where the total acceleration (the sum of the accelerations of all masses) is equal to 0. If, in such a point, the outwardly oriented acceleration increases in all directions, then this point is a *source* of the universal v-field.

From these sources, the flow lines lead into all directions. A subset of the flow lines ends in *sinks*, i.e. in the singularities within black holes.

The flow lines follow at any point exactly the direction of the total acceleration, and the flow velocity at a certain point is always equal to the integral of the acceleration along the flow line from the source up to this point.

Other than in the spherically symmetric case, however, the flow lines do not correspond to the paths of test-bodies in the Newtonian field, since in the case of test bodies inertia forces (conventionally spoken) must be taken into account, whereas the flow lines are always parallel to the direction of the acceleration.

Here an example for illustration:

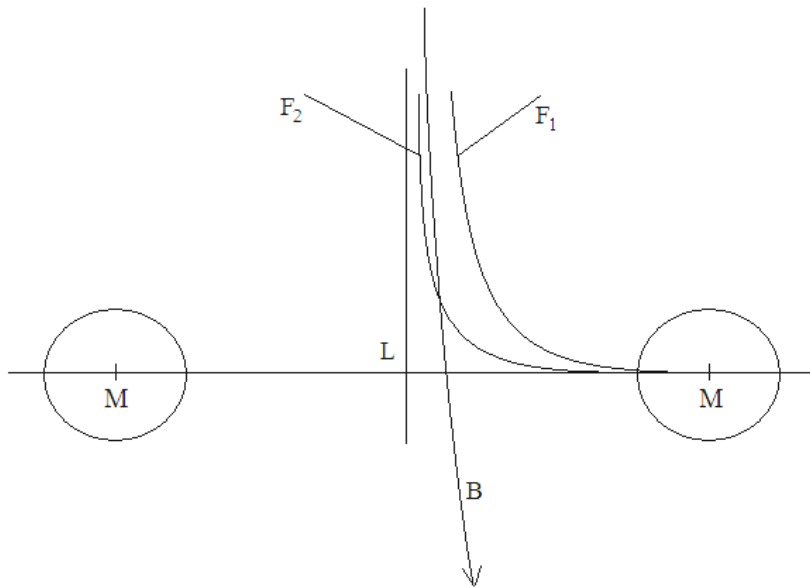

(S9)

L is the medium point between the two equal masses M. F_1 and F_2 are flow lines. B is the path of a test body. It can be seen that no flow line intersects the straight connecting the two masses (no acceleration leads across this straight). L is not a source: in L, the total acceleration is indeed 0, but the outwardly oriented acceleration does not increase in all directions.

The flow lines, which, coming from above, lead through L, would be rectangular at L – however this is just a hint that the picture of the smooth metric flow cannot apply up to arbitrarily small distances.

Actually, the two masses do not rest but rotate around L. Therefore, the flow lines F_1 and F_2 spiral around the symmetry axis through L.

This torsion of the flow lines is an important fact, because the strength of gravity is changed by it.

The objects determine the flow lines. Reversely, they are embedded in the flow lines, such that their dynamics is determined by the flow field.

In the flow, time never changes. Because of equation (1') and due to the definition $\sigma = dr/dr'$, any flow velocity v is connected with a certain length differential $dr'(v)$ in the flow (see equation (34') at the end of the next chapter on antimatter). Therefore, if the flow velocity is known, it is possible to change over from the local flow system to a relativistic observer system through the Lorentz transformation. And if size and direction of the flow are given at any point, then the metric of the respective area is determined by the totality of the local observer systems.

Of particular importance is that, in the metric dynamic view, gravity is not limited to phenomena that occur due to mass or energy. The universe is understood as process of self-organization by flows and waves, and it must be assumed that the phenomena which are usually denominated "gravitation" are just *one variant* of all the dynamic phenomena that follow from the longitudinal metric flow, and that they might even be an exception.

More on this question will follow in the chapter on cosmology.

Also in the description of gravity, the concepts *metric density* and *metric flow* have proven sufficient. It was not necessary to involve any other physical concepts.

Note:

In all considerations about the metric flow, it must be kept in mind that there is *no absolute metric density* but only relative density alterations.

The following outline illustrates this fact:

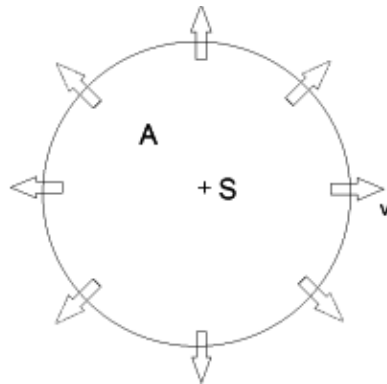

(S10)

Here, a metric flow exists that leads from A to the outside and is equal in all directions. Let us assume this flow to be time-independent. Then in A – despite the flow – the metric density does not decrease.

With this, the following fact is connected:

What was previously called *source* of the flow field is not a source in the usual sense: in the point S, the metric flow starts with the velocity zero. Thus there is no real "inflow".

The Choice of the Sign

In the equation for the velocity of the radial metric flow

$$v = \pm \sqrt{\frac{2m}{r}}$$

we have taken into account only the negative sign. In the case of the positive sign, the direction of the flow would be opposite to the direction of the decreasing metric density, in contradiction to the original assumption in 1.4.

Logically, however, also the positive sign is possible. Then one would have to start with an outwards directed flow $v = \infty$ at the singularity. Thus abandoning this possibility corresponds to the usual assumption that there are no "white holes".

The Area $r < m$

Because of the relations (see Section 2.3.)

$$\sigma = 1 - \frac{m}{r} = \frac{dr}{dr'} \qquad dr' = \left(1 - \frac{m}{r}\right)^{-1} dr$$

the metric density in a point P at the distance m from the center O is equal to zero. The differential dr' becomes finite at this point, so that this distance, measured by dr' , is also equal to zero. (At the transition to a relativistic reference frame, m must be replaced by 2m.)

In the Schwarzschild metric, the problem that there is no space at all within $2m$ can be solved by transformation to another coordinate system. However, in the metric flow concept of gravity this is not admissible, because here the time within the flow does not change.

Of course one can first change over to the Schwarzschild metric and *then* carry out the coordinate transformation. Since the flow concept, however, stems directly from the *origin of everything* and claims therefore to be not just a formal alternative version of gravity but to correspond also ontologically with the real conditions, this approach is unsatisfactory.⁷⁴

Thus I will outline in short, how the metric facts could be interpreted using the resources of non-standard analysis.

We start with the question: If the metric density becomes zero at m , would the continuum *rip* at this point?

Not necessarily. It depends on how it is defined. A continuum whose points correspond to real numbers would rip. But it is possible to define numbers that lie *between* the real numbers. For this purpose, one first defines positive numbers q_1 such that for all these numbers and for all positive real numbers q applies: $0 < q_1 < q$. (Any q_1 is greater than 0, but smaller than any positive real number. The differentials of standard analysis can be defined by such numbers.) Then numbers of the form $(\pm q + q_1)$ lie between the real numbers. Now one repeats the whole procedure with respect to these new numbers and obtains again new numbers $(\pm q + q_1 + q_2)$, which in turn lie between the numbers $(\pm q + q_1)$. Intervals whose lengths correspond to a number q_2 are called *second order differentials*.

A continuum that corresponds to numbers $(\pm q + q_1)$ does not rip if it is stretched so far that distances with a length q_1 (the "normal" first order differentials) become finite, because then intervals with a length q_2 fill out the now finite first order differentials: the numbers $(\pm q + q_1)$ lie still dense and thus prevent the ripping.

Now to the question: Is there actually no space within m ?

In the continuum that consists of real numbers, the answer is *yes*. If a point P lies at the distance m , then this distance, measured by the differential dr' – which is now *finite* –, becomes actually zero.

⁷⁴ It is always possible, however, to fall back on the simple description based on the "absolute viewpoint from outside", which was performed in Section 2.2.

However, in a continuum of the type just described, this is not the case. Here, the distance between P and O is not equal to zero but equal to a number q_1 , and second-order differentials ensure that the metric relations remain defined.

In this way, the concept of metric density can also be applied to the area $r \leq m$. This is necessary, because the circumferences of circles with radii $r \leq m$ remain unchanged, which means they are equal to $2\pi r$ – and they are also seen as such from the outside space –, so that the space in this area cannot simply disappear.

Note on black holes

In the usual general relativistic approach, the action of gravitation leads to the formation of a singularity within the black hole.

From the metric-dynamic point of view, however, that does not seem plausible. Here, gravitation is understood as *metric compression*, caused by self-organization of the metric structure – that is: of the universe.

In the usual approach, gravitation is simply "there" and does not stop acting, whereas in the metric-dynamic approach, it is *caused* by metric waves, and it can not be assumed that the waves can condense *themselves* to a singularity.

Therefore, in the metric-dynamic view of gravitation it is more probable that inside of black holes there is no singularity but a wave phenomenon that perpetuates the metric state by which the black hole is defined.

2.6. The hybrid System

At the transition from the Newtonian approximation of gravity to Einstein's version it was necessary to correct the factor, by which the metric is defined, from $(1 - m/r)$ to $(1 - 2m/r)$.

However what would be the case, if the special relativity theory was part of physics, but the transition from Newton's gravity to the general relativity theory would *not* have taken place?

Then the non-relativistic point of view would have to be maintained – exactly how it was done in Section 2.3 – and the metric factor would remain $(1 - m/r)$.

If the metric flow was factored in *under this condition*, then to its velocity would apply

$$\boxed{v = -\sqrt{\frac{m}{r}}} \quad (21)$$

– because only then the flow velocity would be equal to the light speed at $r = m$, such that the distance of this point from O would be zero, as required by the metric of the system S_N (see (14), (15), (16)).

Formally, this result is achieved if, on the one hand, the equation is applied that is valid in the relativistic view:

$$dr' = dr(1 - v^2)^{-1} \quad \text{or} \quad dr/dr' = (1 - v^2)$$

and, on the other hand, the definition of σ is maintained

$$\sigma = \frac{dr}{dr'}$$

With $\sigma = 1 - \frac{m}{r}$ this leads to

$$1 - \frac{m}{r} = 1 - v^2$$

and therefore $v = \pm \sqrt{\frac{m}{r}}$

As a consequence, the *relativistic* local flow system S_F of (18)

$$S_F: (dt_F = dt, dr_F = (1 - \frac{2m}{r})^{-1} dr, d\phi_F = d\phi)$$

changes to S_F' , which is characterized by:

$$S_F': (dt_F = dt, dr_F = (1 - \frac{m}{r})^{-1} dr, d\phi_F = d\phi)$$

Thus, in the hybrid system, the relativistic local reference system S_F' in the flow corresponds to the local flow-system S_{F_0} that emerges from the Newtonian system by a Galilean transformation.

(As a reminder: the differential measures of S_{F_0} are identical with the ones of the Newtonian system of (14):

$$S_N: (dt_N = dt, dr_N = (1 - \frac{m}{r})^{-1} dr, d\phi_N = d\phi)$$

Why this hypothetical variant?

Because in the following it will actually be necessary to apply the value from (21) to the flow velocity.

The reason is that, in current physics, all interactions except gravity occur within the flat spacetime. From the metric-dynamic point of view, however, this is exactly the state in which gravity has been before Einstein: the state before the metric substantiation of the interaction.

So if we aim at reconstructing various known physical relations based on the concept of metric and flow, these reconstructions will only be possible using the flow value of equation (21). The factor 2, which occurs only due to the transition from a description in the flat spacetime to a relativistic description based on a change of the spacetime metric, does not appear.

I call such a system a "hybrid system", because it contains, on the one hand, the pre-metric view – which is indeed necessary for reconstructing relations that belong to this view – and, on the other hand, also the metric flow that is the basic concept of the reconstruction.⁷⁵

⁷⁵ By the way, I have always been wondering about the fact that the Schwarzschild solution of Einstein's field equations corresponds only to the Newtonian approximation in the case of sufficiently weak gravity, if, at the end of the derivation, as integration constant not m , but $2m$ (exactly: $\ln(2m)$) is chosen. The geometric mass m and the Newtonian mass M are connected only by natural constants ($m = MG/c^2$). So why should a factor 2 occur?

2.7. Concluding Remarks

If the fundamental law (1) represents indeed the *mechanism of the universe*, then gravitation must follow from this law.

In this chapter, it was demonstrated that this is true.

The fundamental law has two interpretations: the one relates to changes of the length scale, the other one to changes of the angle scale. Gravitation can be identified with the laws that follow from the changes of the length scale. In particular, the gravitation exerted by a central mass corresponds to a stationary spherically symmetric flow towards the center.

However, I have presented not a theory but only the design of a theory. This design proved successful in some applications. (It seemed appropriate to me to choose the first two historical tests of general relativity.)

In the simple cases analyzed here, the results correspond to those of general relativity. Does this mean the new theory will be merely a variant of the general theory of relativity?

No, because there is the following fundamental difference:

Compared to a Euclidean continuum, the continuum of the general theory of relativity is distorted, but it is (at least in general) *static*, whereas the metric dynamic continuum is *dynamic*: it organizes itself through flows and waves. Therefore the metric dynamic view leads to a completely different cosmology. This will be discussed later. At this point, I shall emphasize another difference that is of particular importance:

Due to the fact that, in the metric-dynamic view, gravitation relates only to the changes of the length measures, there is room for other interactions within three-dimensional space.

The angles are not involved. Therefore it is possible to assign the electromagnetic interaction to the changes of the angle measures. (This will be carried out in the 5th chapter.)

I think, the explanation is exactly the fact that, in the non-relativistic description, there is no factor 2. It appears only at the transition to the relativistic view.

It is certainly surprising that this separation becomes visible only in the *non-relativistic* version of the new approach to gravity. So it seems that the astonishing simplicity of the circumstances reveals itself only to the "absolute" view from "outside"!

The new outline of gravity is incomplete in one important respect:

Objects, which cause gravity, were described as stationary flow-states, which correspond to "black holes". However gravitating material objects – particles – are presumably not black holes but space-time patterns generated and maintained by waves.

This means that the metric flow, which was deduced here, applies only beyond a certain distance from the center.

A consequence of this incompleteness is that the description of objects which cause gravitation is not identical with the description of objects on which gravitation acts:

Objects, which gravitation acts upon, are interpreted as superpositions of waves with light speed and are in this way embedded in the flow field.

However objects, which cause gravitation, are not described as wave superposition but as steady states, where waves do not occur.

This difference could only be eliminated by a model that contains the processes that lead to the generation of steady wave-states, in other words: by a wave-model of particles that informs how a spherically symmetric defect of the metric is realized and how it is maintained.⁷⁶ Some preparatory steps towards such a model will be made in Chapters 4 and 5.

Finally, it should be pointed out that the conceptual origin of general relativity – the equivalence of gravity and inertia – is implemented in the metric-dynamic model directly and in the simplest possible manner:

Here, holding an object in a gravitational field caused by a mass at a constant distance to this mass, means permanently accelerating the object against the accelerated flow towards the mass, and this is of course the same as accelerating the object in an area without gravity.

⁷⁶ A natural assumption would be that the superposition of waves, by which the material object is formed, causes a metric densification.

As was shown, however, only the assumption that the objects themselves are nothing but superpositions of metric waves leads to correct results, i.e. to results that match those of GR.

To illustrate these circumstances, we ask at last: Why are we held down to the earth by gravity? Seen from the metric-dynamic point of view, the answer is:

Because an accelerated metric flow moves through us with a velocity of 11.2 km/s. We ourselves are (ultimately) patterns of waves with light speed in the flow, and this has two consequences: *first*, the waves (ourselves) must be accelerated against the flow – which is ensured by the electromagnetic interaction with the surface of the earth – and *second*, the waves must always move a bit against the flow – and this is the reason why time progresses more slowly. (The paths of the waves are longer than they would be without flow.)

3. Antimatter

3.1. Matter and Antimatter as opposite metric Deformations

Under what circumstances disappears a metric deformation, which, associated with a metric flow, forms a stable, steady state? If and only if it meets the opposite metric deformation.

Matter and antimatter annihilate each other. From the metric-dynamic point of view, this means that the metric differences of matter and antimatter cancel each other out.

We assume the metric defect described in the previous chapter to be the one of matter. The simplest formulation of this defect is that the continuum lacks a (metric) sphere with Radius m : in the metrically altered continuum, any radial distance from the center of gravity O is by m units smaller than in the Euclidean continuum.

Therefore, in the case of antimatter must be assumed that any radial distance from the center is by m units *greater* than in the Euclidean continuum; there is (so to speak) a metric sphere with radius m *too much*.

So let r be the distance of an arbitrary point from the center O in a Euclidean continuum, r_A the distance of the same point from O , measured in the continuum altered by antimatter. Then the following applies:

$$r_A = r + m \tag{22}$$

This means: If matter has the geometric mass $m > 0$, then the equal (symmetrical) amount of antimatter has the mass $-m$.

In the case of matter, the metric density $\sigma(r)$, according to (7), is given by

$$\sigma = \frac{r - m}{r}$$

Thus, in the case of antimatter, we have to set

$$\sigma = \frac{r + m}{r} \quad (23)$$

We denominate the altered radial differential no longer dr_N , but dr_A . According to the definition of σ

$$\sigma = \frac{dr}{dr'}$$

applies then: $dr_A = \left(1 + \frac{m}{r}\right)^{-1} dr$ (24)

3.2. Gravitation in the Case of Antimatter

Now we will determine the gravitation of antimatter, that is: the gravitation which follows from the metric defect that represents the opposite of the metric defect in the case of matter.

In order to determine the metric flow, (1') has to be rearranged as in 2.1. (c is set to 1)

$$\frac{d\sigma}{dr} = -\frac{dv}{dt} \quad \longrightarrow \quad d\sigma = -\frac{dr}{dt} dv \quad (25)$$

Again we set $\frac{dr}{dt} = v$

Accordingly $d\sigma = -v dv$

Integration gives $\sigma = -\frac{v^2}{2} + C$

According to (23), however, no longer applies

$$\sigma = \frac{r - m}{r}$$

but instead
$$\sigma = \frac{r + m}{r}$$

Therefore
$$1 + \frac{m}{r} = -\frac{v^2}{2} + C$$

The integration constant C follows again from the condition $v = 0$ for $r \rightarrow \infty$.

From this follows $C = 1$

This leads to
$$\frac{v^2}{2} = -\frac{m}{r}$$

and, finally
$$\boxed{v = \pm i \sqrt{\frac{2m}{r}}}$$
 (26)

In the case of antimatter, the flow becomes imaginary.

Then, because of $v = \frac{dr}{dt}$, also r must be imaginary. (The time remains always unchanged.)

If we replace in (1') v by iv and r by ir,

thus
$$\frac{d\sigma}{dir} = -\frac{div}{dt}$$

then we get to
$$\boxed{\frac{d\sigma}{dr} = +\frac{dv}{dt}}$$
 (27)

If (1') is understood as relation of real-valued quantities – that is: of measurable quantities – then in the fundamental equation, in the case of antimatter the sign changes.

To determine the (real) flow-acceleration, we differentiate

$$\sigma = \frac{r + m}{r} \quad \text{with respect to } r.$$

This gives $\frac{d\sigma}{dr} = -\frac{m}{r^2}$

According to (27) $\frac{d\sigma}{dr} = \frac{dv}{dt}$

applies then $\boxed{\frac{dv}{dt} = -c^2 \frac{m}{r^2}}$ (28)

In the case of antimatter, the flow-acceleration is identical with that of matter. Thus the Newtonian approximation is in both cases identical.

Why do imaginary numbers occur in the case of antimatter? The reason is that here – as follows from (24)

$$dr_A = \left(1 + \frac{m}{r}\right)^{-1} dr$$

– the radial differential dr_A , compared with the differential of the Euclidean continuum, is *shortened*.

Therefore, the usual description by an auxiliary dimension is only possible if this dimension is imaginary:

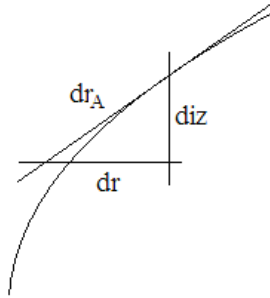

(S11)

In (S11) is $dr_A^2 = dr^2 - dz^2$

Thus, only if the auxiliary dimension is imaginary, applies $dr_A < dr$.

Or let us look at the flow:

$$v = -i \sqrt{\frac{2m}{r}}$$

If we now, as before in the case of matter, judge the velocity of the flow, as it is seen non-relativistically "from outside", then this correction will lead – as can be seen in the following outline – to an *increase* of the light speed

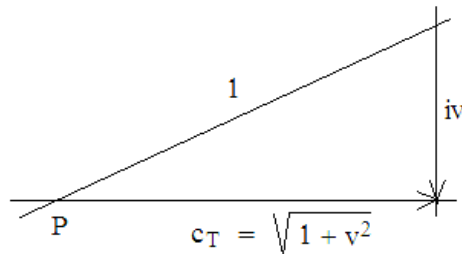

(S12)

Here, the flow-corrected light speed c_T is greater than the normal light speed. This is simply because, in the case of antimatter, the circumferences of circles around the center O are *shorter* than in the

Euclidean continuum. Therefore, the time that light requires for one orbit, is shorter – or, alternatively, light appears to be faster (of course only from a non-relativistic point of view.)

But from that follows now a change against the usual view:

In the case of antimatter, gravity is smaller than in the case of matter of identical mass |m|.

If e.g. the calculation of the perihelion precession is carried out exactly as in section 2.2, however now, according to (S12), using the factor

$$k = \sqrt{1+v^2} = \sqrt{1+\frac{2m}{r}}$$

then the result is

$$\frac{\omega'}{\omega} = \left(1 - \frac{2m}{r}\right)^{\frac{3}{2}} \approx 1 - \frac{3m}{r} \quad (29)$$

Thus there is no precession but *retardation*: the ellipse rotates in the reverse direction, i.e. against the direction of motion.

Though the correction of the Newtonian approximation is completely analogous to the one in the case of matter, it leads not to an increase but to a decrease of gravity.

Now we determine the metric circumstances in a relativistic reference system S_{Λ} that rests relative to the center point O.

At first we must factor in – just in the same way as in the case of matter – that from a relativistic point of view the metric defect is not m but $2m$. Any radial distance from the center is by $2m$ greater than in the undistorted continuum.

The length differential of the flow-system S_F is therefore (compare (17)):

$$dr_F = dr \left(1 + \frac{2m}{r}\right)^{-1} \quad (30)$$

The time differential remains unchanged: $dt_F = dt$

Therefore, a local system S_F in the flow is characterized by

$$S_F: (dt_F = dt, dr_F = (1 + \frac{2m}{r})^{-1} dr, d\phi_F = d\phi) \quad (31)$$

Now, from S_F can be transformed to a local (relativistic) observer system S_A , which is at rest relative to O , however not, as in the case of matter, with the factor

$$\sqrt{1 - \frac{2m}{r}}, \quad \text{but with} \quad \sqrt{1 + \frac{2m}{r}}$$

The reason for this change is that from

$$\frac{v}{c} = \pm i \sqrt{\frac{2m}{r}}$$

follows with respect to the factor of the Lorentz transformation:

$$k = \sqrt{1 - \frac{v^2}{c^2}} = \sqrt{1 + \frac{2m}{r}}$$

Thus the radial length differential dr_A of S_A is:

$$dr_A = dr_F k = dr (1 + \frac{2m}{r})^{-1} (1 + \frac{2m}{r})^{\frac{1}{2}} = dr (1 + \frac{2m}{r})^{-\frac{1}{2}}$$

and the time differential dt_A is:

$$dt_A = dt (1 + \frac{2m}{r})^{\frac{1}{2}} \quad (\text{note } dt_F = dt)$$

From this follows the metric:

$$ds^2 = \left(1 + \frac{2m}{r}\right) dt^2 - \left(1 + \frac{2m}{r}\right)^{-1} dr^2 - r^2 d\phi^2 \quad (32)$$

In the case of antimatter, the metric is not identical with the Schwarzschild metric. In particular, the passing of time is not decelerated but accelerated.

Thus, here objects are accelerated in the direction of the area of accelerated time.

For illustration of the metric circumstances, here an outline of the parabola P2, which – analogously to the Schwarzschild parabola – depicts the metric with the aid of an embedding dimension iz :

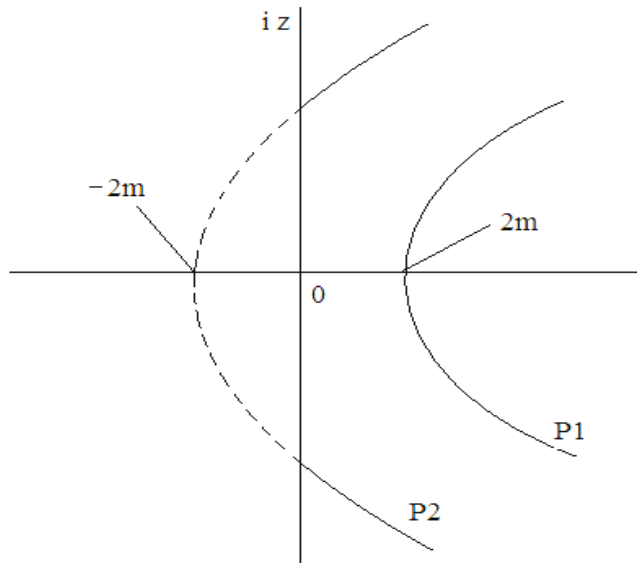

(S13)

P2 is the parabola, which illustrates the metric facts of (32). The auxiliary dimension iz is imaginary. (The Schwarzschild parabola P1 is shown only for comparison; for P1, the auxiliary dimension would of course have to be real.)

In the flow-concept, the metric circumstances are symmetrical for matter and antimatter. Nonetheless this leads to a different gravity.

3.3. *Asymmetry of Matter and Antimatter*

In addition to the different strength of gravity (in the case of the same m), there are also the following asymmetries between matter and antimatter:

In the case of matter, the following equations apply:

$$\frac{\partial \sigma}{\partial r} = - \frac{1}{c^2} \frac{\partial v}{\partial t} \quad (1')$$

$$\frac{\partial v}{\partial r} = - \frac{\partial \sigma}{\partial t} \quad (1a)$$

From these equations ensues the wave equation:

$$\frac{\partial^2 v}{\partial r^2} = \frac{1}{c^2} \frac{\partial^2 v}{\partial t^2} \quad (3)$$

But in the case of antimatter, the positive sign on the right side in (27)

$$\frac{d\sigma}{dr} = + \frac{1}{c^2} \frac{dv}{dt}$$

prevents the derivation of the wave equation from (27) and (1a). Instead follows

$$\frac{\partial^2 v}{\partial r^2} = - \frac{1}{c^2} \frac{\partial^2 v}{\partial t^2} \quad (3')$$

This means: *In the continuum that is metrically altered by antimatter, there are no stable longitudinal waves.*

In the metric dynamic view, where everything that exists is understood as wave superposition, this represents a fundamental restriction.

*The most important asymmetry, however, concerns the **formation** of matter and antimatter:*

In the metric dynamic universe, matter-particles evolve through metric densification processes, which are part of the global metric self-organization that occurs in the whole universe. Into such areas of increased metric density, flow lines enter which then either disappear in a sink – in the singularity of a black hole – or end in a point within this area, such that the flow velocity *decreases* more and more, until it reaches zero in that point.

The beginning of each of these flow lines lies in a point, where the flow velocity *increases* in all directions. Further above, I called such a point a *source*, though this designation is actually not correct, since also here the flow velocity starts with the value zero.

With respect to the problem of the asymmetry of matter and antimatter, however, only the following is relevant:

The velocity of the flow along these flow lines, from the beginning to the end, has always a real value, with other words: the universe organizes itself exclusively through *real* longitudinal flows.

Antimatter, however, is characterized by the occurrence of an *imaginary* longitudinal flow.

From this follows:

Seen from the metric dynamic view-point, the assumption that always the same amount of matter and antimatter is generated cannot be maintained: within the global self-organization, matter evolves without antimatter being generated at the same time.

Locally, however, this assumption remains true: if locally a metrically densified area is generated, then a symmetric area of reduced metric density will evolve, which is surrounded by an area of imaginary metric flow; a *local* change of the metric density is not possible without the opposite local change. Therefore, in laboratory experiments, only particle-antiparticle pairs can be generated.

3.4. Summary

I close with a short summary.

Let K^n ($n>1$) be a n -dimensional continuum, distorted by a geometric mass m .

If $m > 0$, then m is the geometric mass of *matter*, and any distance from the center O is by m length units *smaller* than in the undistorted continuum

If $m < 0$, then m is the geometric mass of *antimatter*, and any distance from the center O is by m length units *greater* than in the undistorted continuum.

In this way it is immediately clear why matter and antimatter with identical absolute value of m annihilate each other when they meet: the metric changes are opposite to one another and cancel each other out.⁷⁷

The acceleration field, which corresponds to the Newtonian approximation, is in both cases identical:

$$\frac{dv}{dt} = -c^2 \frac{m}{r^2}$$

The metric flow toward the center is in the case of matter real, in the case of antimatter imaginary:

$$\text{Matter: } v_M = \pm c \sqrt{\frac{2m}{r}} \quad \text{Antimatter: } v_{AM} = \pm i c \sqrt{\frac{2m}{r}}$$

The squares of the flows cancel each other out: $v_M^2 + v_{AM}^2 = 0$

From the fact that the metric flow caused by antimatter is imaginary follows that the gravitation of antimatter with mass $-m$ is not identical with the gravitation of matter with mass m , but *weaker*.

⁷⁷ The fact that energy is emitted in the form of waves at such an impact proves that matter and antimatter consist of waves, and it proves also that the respective metric changes are caused by these waves.

The metric of the surrounding continuum is

$$ds^2 = \left(1 + \frac{2m}{r}\right) dt^2 - \left(1 + \frac{2m}{r}\right)^{-1} dr^2 - r^2 d\phi^2$$

Thus time passes *faster* in the continuum distorted by antimatter.

There are further asymmetries between matter and antimatter:

1. *In the case of antimatter, there are no waves of the longitudinal metric flow v and of the metric density σ .*

2. **Locally**, always the same amount of matter and antimatter is generated; **globally**, however, only matter is formed.

At last a note on the connection between metric density σ , flow velocity v and length differential dr (c is set to 1):

From $\sigma = 1 - \frac{m}{r}$ and $v^2 = \frac{2m}{r}$

follows $v = \pm \sqrt{2} \sqrt{1 - \sigma}$ (33)

σ can assume any real value, v can assume any real and any imaginary value. If σ is equal to 1, then v is equal to 0. If $\sigma < 1$ (at matter), then v is real. If $\sigma > 1$ (at antimatter), then v is imaginary. With the exception of the sign, the mapping is bijective.

With $\sigma = \frac{dr}{dr'}$

follows $dr' = dr \left(1 - \frac{v^2}{2}\right)^{-1}$ (34)

At the transition to a relativistic view, for the length differential in the flow (see section 2.4, (17) and (18)) applies:

$$dr_F = dr (1 - v^2)^{-1} \quad (34')$$

and, with respect to a resting observer:

$$dr_B = dr (1 - v^2)^{-1/2} \quad (34'')$$

(33) to (34'') apply in general, not only in the spherically symmetric, stationary case.

4. Planck-Length, geometric Mass and Particle-Frequency

In this short chapter, the hypothesis shall be formulated which, in the metric dynamic model, substantiates the fact that in nature the values of various observables appear only in discrete sequences, which can be expressed as integer multiples of a fundamental unit.

In the metric-dynamic scenario that follows in 4.2, the connection between Planck-length, geometric mass and the two quantities frequency and Compton wave-length that are linked to this geometric mass will be explained. This means: the Planck-length can be derived from Compton wave-length and geometric mass in a metric-dynamic way.

4.1. *The metric dynamic Quantization Hypothesis*

We have already deduced that in the metric flows longitudinal waves exist. (See wave equations (3) und (5)). Now, in regard to these waves, we make an additional assumption.

*In the metric flows, whose stationary, spherically symmetric states turned out to be the gravity of a central mass, standing waves exist. Their wave-length λ is equal to the Planck length. They represent the basis of the material structures.*⁷⁸

Thus $\lambda := \text{Planck length} := \lambda_{\text{pl}}$

where $\lambda_{\text{pl}} = \sqrt{\frac{hG}{c^3}} = 4.051 \dots 10^{-35} \text{ (meter)}$.

What in standard physics is a quantum of action is here a quantum of length.

To demonstrate the consequences of this metric quantization, I will immediately join the first application. It bridges more than 40 orders of magnitude and provides a metric dynamic reasoning of some well-known relationships between fundamental quantities.

⁷⁸ If the universe was a closed metric structure, then the image of standing waves would be *the first and simplest* idea which would come to mind if one thought of consequences of self-organization. (Only the extraordinary small wave-length would be surprising.) The problem, which occurs due to the assumption that the universe is *open*, will be discussed in the chapter on cosmology.

4.2. Phase Waves in the radial Flow; Connection between Mass and Frequency

Let us look at a stationary, spherically symmetric flow v into a center of gravity Z .

Seen from an observer who rests at Z , the standing Planck-waves in the flow are *not* standing waves. From his point of view, the flow is a moving system. Therefore, the phase coincidence is canceled by the Lorentz transformation.

$$\text{Thus } f(r,t) = \sin(2\pi t v_{\text{pl}}) \cos(2\pi r \frac{1}{\lambda_{\text{pl}}}) \quad (v_{\text{pl}} \lambda_{\text{pl}} = c) \quad (35)$$

– which represents a standing wave *in the flow system* – turns, seen from the resting observer, into

$$f'(r,t) = \sin 2\pi (t v_{\text{pl}} \frac{1}{k} - r v_{\text{pl}} \frac{v}{c^2} \frac{1}{k}) \cos 2\pi (t v \frac{1}{\lambda_{\text{pl}} k} - r \frac{1}{\lambda_{\text{pl}} k}) \quad (k = \sqrt{1 - \frac{v^2}{c^2}}) \quad (36)$$

For the resting observer, the standing wave in the flow transforms into a wave superposition, which consists of the two waves

$$\Psi_1(\lambda_1, \nu_1) \text{ and } \Psi_2(\lambda_2, \nu_2)$$

where

$$\lambda_1 = \lambda_{\text{pl}} \frac{c}{v} k \quad \nu_1 = v_{\text{pl}} \frac{1}{k} \quad (37)$$

$$\lambda_2 = \lambda_{\text{pl}} k \quad \nu_2 = v_{\text{pl}} \frac{v}{c} \frac{1}{k} \quad (37')$$

Now we determine the distance r_1 from Z , which is equal to one wave-length λ_1 of the phase wave Ψ_1 , which has emerged from the transformation.

In addition to the phase shift described by (36), we must take into account that the length differential in the flow is greater than that of the resting system by the factor $1/k = (1 - (v/c)^2)^{-1/2}$. Therefore, the wave-lengths in the flow are enlarged by the factor $1/k$.

Thus we set

$$r_1 = \left(\lambda_{pl} \frac{c}{v} k \right) \frac{1}{k}$$

(On the r-dependency of v , λ_1 and k see the note further below.)

$$r_1 = \lambda_{pl} \frac{c}{v} \tag{38}$$

How big is the flow $v(r)$? Here, the conditions correspond to the ones of the hybrid system described in section 2.6. Therefore, the flow-value from (21) must be chosen:

$$\frac{v}{c} = -\sqrt{\frac{m}{r}} \quad (\text{m is the geometric mass})$$

With $\frac{c}{v} = \sqrt{\frac{r_1}{m}}$ (here, only the absolute value of v is relevant), (38) turns into

$$r_1 = \lambda_{pl} \sqrt{\frac{r_1}{m}}$$

Therefore

$r_1 = \frac{\lambda_{pl}^2}{m} \quad \text{or} \quad r_1 m = \lambda_{pl}^2 \tag{39}$
--

Note: In determining the distance r_1 as equal to one phase wave-length – would not have to be taken into account that the flow v , which the wave-length depends on, is *not* constant within r_1 ?

This is not necessary, as can be shown in the following way: to determine *all* distances, where the phase shift is equal to 2π , instead of (38) must be set more generally

$$r_n = n \lambda_{pl} \frac{c}{v} = n \lambda_{pl} \sqrt{\frac{r_n}{m}}$$

with the consequence

$$r_n = n^2 \frac{\lambda_{pl}^2}{m}$$

Now imagine $r \rightarrow r' = \sqrt{r}$.

Then all wave lengths of the phase wave become equal to $\sqrt{r_1}$: the first wave length ends at $\sqrt{r_1}$, the second one at $2\sqrt{r_1}$ etc. Thus it can be seen that there is only *one single phase wave*. After the re-transformation $r' \rightarrow r$, the wave length of the phase wave increases with r , such that the first wave length ends at r_1 , the second one at $4r_1$ and die n^{th} one at $n^2 r_1$.

Let us again look at relation (39):

r_1 , the distance from Z, is equal to λ_1 , the wave length of the phase wave (that exists in the resting system because of the Lorentz-Transformation of the standing wave in the flow), if

$$r_1 = \frac{\lambda_{pl}^2}{m}$$

This, however, means: r_1 is equal to the *Compton wave-length* λ_C , because

$$\lambda_C = \frac{\lambda_{pl}^2}{m}$$

(E.g. in the case of an electron:

$$m_e = 6.763 \cdot 10^{-58} \text{ (meter)}, \quad \lambda_{pl} = 4.051 \cdot 10^{-35}$$

$$\frac{\lambda_{Pl}^2}{m_e} = 2.426 \cdot 10^{-12} = \lambda_{Ce})$$

Moreover, at the position r_1 , in addition to the almost unchanged Planck-frequency

$$\nu_1 = \nu_{Pl} \frac{1}{k}$$

another, much smaller frequency appears (see (37'))

$$\nu_2 = \nu_{Pl} \frac{v}{c} \frac{1}{k} = \nu_{Pl} \sqrt{\frac{m}{r_1}} \frac{1}{k} \quad (40)$$

which, because of $\nu_2 \lambda_1 = \nu_2 \lambda_C = c$, corresponds to the frequency ν_m of a particle with the geometric mass m .

The flow, which the phase wave originates from, is spherically symmetric. This means:

On the surface of a sphere with radius λ_C there is an in-phase oscillation with the frequency of the particle.

Of course this is not yet a model of a particle. On the other hand, however, it is also more than just a mathematical relation between particle mass and particle frequency, because it contains a structural element: the concept of an in-phase oscillation on the surface of a sphere. (Exactly this concept will be required in the next chapter.)

The just derived relation between the frequency ν_m , the wave-length λ_m (with $\nu_m \lambda_m = c$) and the geometric mass m is not only true in the case of a particle, but also in general.

Therefore it can be asserted: The equations (41) and (41')

$\lambda_m m = \lambda_{Pl}^2 \quad (41)$

and, because of $\lambda_m v_m = c$

$$m c = \lambda_{pl}^2 v_m \quad (41')$$

are the metric-dynamic equivalent of $M c^2 = h\nu$ or $E = h\nu$ and $E = M c^2$.

(In section 6.2, equation (41') will assume exactly this form, that is: $M c^2 = h\nu$.)

If one sets alternatively $\tilde{\lambda}_{pl} = \sqrt{\frac{\hbar G}{c^3}} = 1.616... \cdot 10^{-35}$ (meter), then applies (with $\tilde{\lambda}_m = \lambda_m / 2\pi$)

$$\tilde{\lambda}_m m = \tilde{\lambda}_{pl}^2 \quad (41'')$$

Note

In (41) can be seen that λ_{pl} is the geometric mean of m and λ_C .

This means: There is a simple indication that a relation between three quantities in a metric flow, the velocity of which is inversely proportional to $r^{1/2}$, is possibly mediated by a phase wave: if all three quantities are expressed as lengths, then one length must represent a metric defect, and another length must be the geometric mean of the other two. (At the reconstruction of the atomic structure, we will encounter another such case.)

Scaled logarithmically, the quantities m , λ_{pl} and λ_C , the relation of which is mediated by the radial flow v , can be illustrated as follows:

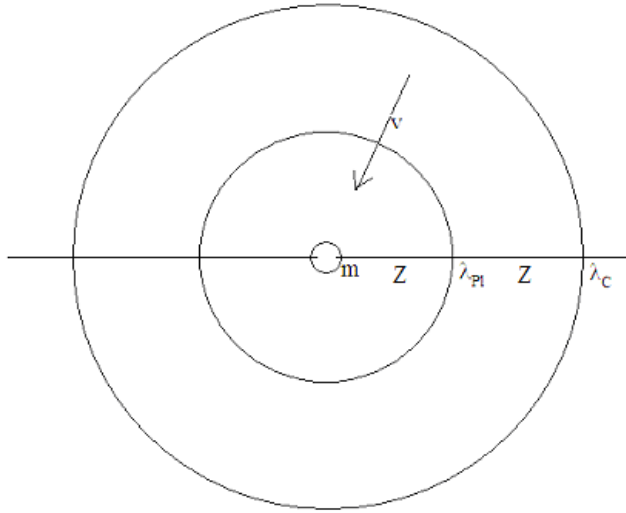

(S14)

Z is a multiplicative factor that belongs to gravity in a similar way as the fine-structure constant $1/\alpha$ to electromagnetism. (More on that will follow starting in section 5.7.)

It holds that: $m Z = \lambda_{PI}$ and $\lambda_{PI} Z = \lambda_C$ (42)

For the electron is $Z_E = 5.990 \cdot 10^{22}$

For the proton is $Z_p = 3.262 \cdot 10^{19}$

In (S14), λ_{PI} and λ_C can be replaced by $\tilde{\lambda}_{PI}$ and $\tilde{\lambda}_C$. Then the depicted facts do not correspond to (41), but to (41'')

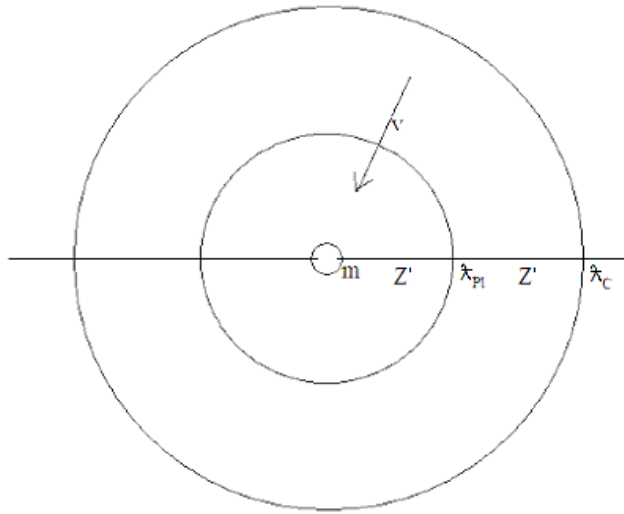

(S14')

Here is $m Z' = \hat{\lambda}_{pl}$ and $\hat{\lambda}_{pl} Z' = \hat{\lambda}_c$ (42')

For the electron is $Z'_E = 2.390 \cdot 10^{22}$

For the proton is $Z'_p = 1.3014 \cdot 10^{19}$

The just designed model represents a *phase wave structure*, by which the relation between the quantities *Planck-length, mass and frequency* – not only in the case of a particle but in general – is substantiated in a geometrical way or, to put it more exactly: in a metric-dynamic way

5. Electromagnetism; Model of the Atomic Structure

5.1. Preliminary Note

Gravitation – in the form of the general relativity theory – and electromagnetic interaction – in the form of quantum electrodynamics – differ from each other in several respects. Here is a table with some facts:

G is the distorted spacetime	EM occurs <i>within</i> the flat spacetime
G is always positive	EM is positive and negative
G is a pseudo-force; all objects move on geodesics	The interaction takes place through exchange of particles
The frequency-difference of two identical particles located at different distances from a mass can be explained in <i>two</i> ways: by the different passing of time and by the energy difference	The frequency-difference of two electrons located at different distances from the positively charged nucleus can be explained in only <i>one</i> way: by the energy difference
G cannot be isolated	EM can be isolated, but in the environment of a completely isolated charge there are still detectable effects on the phases of electrons
G acts universally	EM acts only upon charged objects

Even if there are some formal similarities, the just listed differences appear so essential that it is doubtful whether the areas of the phenomena described by the two theories can be combined into a single representation – at least as regards the current form of the theories. They appear like two buildings, each of which follows a compelling inner logic, but which obey completely different functional and aesthetic principles. Involuntarily, one is reminded of Wolfgang Pauli's phrase: "What God has separated, man should not put together."

However I do not believe that the incompatibility of the two interactions is imposed by God or nature. Rather I think that it is an artifact of our approach to nature, which dissolves into nothing if this approach is changed in an appropriate way. In fact, all the characteristic features of both interactions arise so to speak "by themselves" if just the program is continued that started with the metric-dynamic representation of gravity.

Gravity turned out to be the accelerated metric flow that follows from changes of the longitudinal metric density. In the spherically symmetric case, gravity is a stationary state of the longitudinal metric flow, caused by a change of the differential radial measure dr .

With this, the interpretation of the longitudinal parameters metric density and metric flow is finished – in the sense that they are bound to gravity and cannot be used anywhere else. However besides the parameters metric length density and longitudinal metric flow, in the metric dynamic universe there are only two further parameters: metric angle density and transversal metric flow.

That results inevitably in the assumption that electromagnetism, in the spherically symmetric case, is a stationary state of the *transverse* metric flow, caused by a change of the differential angle measure $d\varphi$. This simple assumption will lead us now – completely without quantum theory – deep into the realm of the quantum theoretic phenomena.

5.2. Definition

Everything which follows below refers to the spherically symmetric case of a central geometric mass m or a central geometric charge μ . ($m \in \mathbb{R}$, $\mu \in \mathbb{R}$. Both m and μ have the dimension *length*.) Three spatial dimensions are presupposed. r and φ are polar coordinates at an arbitrary plane through the center O . σ is the metric density of the length, η is the metric density of the angle. c is set to 1.

Gravitation is *change of the metric density of the length*. In the case of a central geometric mass $m > 0$, the metric length-density $\sigma(r)$ decreases towards the center O . The distance between O and any given point is smaller by m units than in the undistorted continuum. ($2m$ in the relativistic view.)

Electromagnetism is *change of the metric density of the angle*. In the case of a central geometric charge $\mu > 0$, the metric angle-density $\eta(r)$ decreases towards O . The circumference of any given circle around O is smaller by $2\pi\mu$ units than in the undistorted continuum. (This means: here, a whole circle has *less* than 360° . The circle with radius μ has 0° , i.e. its circumference disappears.)

To illustrate the almost complete analogy between gravity and electromagnetism (in regard to the parameters metric length density σ , longitudinal metric flow v and radial differential dr on the one side, and metric angle density η , transversal metric flow w and angle differential $d\phi$ on the other side), I shall confront the definition of EM and the elementary facts ensuing from it with the analogous circumstances of G.

Gravitation

$$\sigma = \frac{r - m}{r}$$

(7)

m is the *geometric mass*

$m > 0 \Leftrightarrow$ matter

$m < 0 \Leftrightarrow$ antimatter

$$\sigma = \frac{dr}{dr'}$$

(12)

$$dr' = \left(1 - \frac{m}{r}\right)^{-1} dr$$

(13)

Electromagnetism

$$\eta = \frac{r - \mu}{r}$$

(43)

μ is the *geometric charge*

$\mu > 0 \Leftrightarrow$ positive charge⁷⁹

$\mu < 0 \Leftrightarrow$ negative charge

$$\eta = \frac{d\phi}{d\phi'}$$

(44)

From (43) and (44) follows

$$r d\phi' = \left(1 - \frac{\mu}{r}\right)^{-1} r d\phi$$

(45)

The ratio of the arc lengths $r\phi'$ and $r\phi$ is the inverse of the ratio of the arc differentials $r d\phi'$ and $r d\phi$:

⁷⁹ For the moment, assigning $\mu > 0$ to *positive* charge is a decision at will. Further below it will turn out that this assignment is necessary for achieving congruence with quantum mechanical specifications and results.

$$\frac{r'}{r} = 1 - \frac{m}{r} \quad (15)$$

This means: Any radial distance is by m units smaller or greater:

$$PO = r \quad \Leftrightarrow \quad (PO)' = r - m$$

(S' is a non-relativistic system; thus, at the transition to a system that moves relative to O, no changes of measures occur.)

The arc differential $r d\phi$ and the time-differential dt remain unchanged:

$$r d\phi' = r d\phi, \quad dt' = dt$$

$$\frac{r \phi'}{r \phi} = 1 - \frac{\mu}{r} \quad (46)$$

From (46) follows: The circumference $2\pi r$ of a circle around O is by $2\pi\mu$ shorter or longer:

$$U = 2\pi r \quad \Leftrightarrow \quad U' = 2\pi(r - \mu)$$

(S' is an non-relativistic system; thus, at the transition to a system that rotates around O, no changes of measures occur.)

The radial differential dr and the time-differential dt remain unchanged:

$$dr' = dr, \quad dt' = dt$$

5.3. *The metric Flow that rotates around the Center*

In the following, the reference systems S, S' and S_F will be used.

S is the Euclidean (charge-free) reference system. S' is (as was S_N at the description of gravity) the reference system, which is at rest relative to O and whose metric is changed by the charge. S' is non-relativistic, so with respect to S', the light speed is not constant. (This is again "the exact view from outside"; see section 2.2.) S_F is (as it was at the description of gravitation) a local system that moves with the flow. (S_F has the same differential measures as S'. As is always the case, relative to the flow the local light speed is constant. Therefore, from S_F can be transformed locally into a relativistic reference system.) Since statements on any system S_F apply always to all S_F, I shall label, for the sake of simplicity, also the "rotating system" – i.e. the total system which contains all local systems that rotate with the flow around O – by the identifier S_F.

Equation (34')

$$dr_{\text{F}} = dr (1 - v^2)^{-1}$$

shows the general relationship between the flow velocity v and the length differential dr_F in the flow. Thus this relationship must also apply to the transversal flow velocity w and the length differential in the transversal flow.

In the spherically symmetric case, the transversal flow rotates around the center (see outline (S15) further below), and therefore the length differential in the transversal flow is identical with the arc differential $r d\varphi_F$. Thus according to (34') applies

$$r d\varphi_F = r d\varphi (1 - w^2)^{-1} \quad (47)$$

Then
$$1 - w^2 = \frac{r d\varphi}{r d\varphi_F} = \eta = 1 - \frac{\mu}{r}$$

and thus⁸⁰
$$w = \pm \sqrt{\frac{\mu}{r}} \quad (48)$$

In the case of positive charge $\mu > 0$, w is real, at negative charge $\mu < 0$, w is imaginary.

Here is an outline that illustrates the transversal flow. In the spherically symmetric case, this flow rotates around O . Depicted is an arbitrary plane through O . P is a point at the distance r from O .

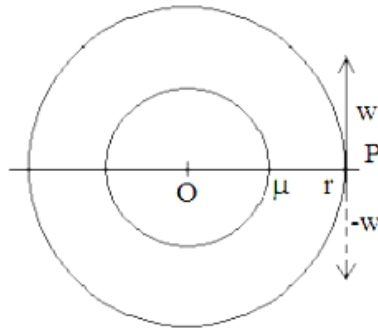

(S15)

⁸⁰ Also here, as in the previous chapter, the conditions of the hybrid system are met, since the usual description of the electromagnetism takes place in the flat spacetime. Thus the factor 2 does not apply. (See 2.6.)

Since (S15) applies to *any* plane through O, to the point P must be assigned the velocity $w(r)$ or $-w(r)$ *in any direction* on the tangent plane to the sphere, where P is located.

I shall refer to this peculiar fact, which exhibits already quantum mechanical features, a little later extensively.

What has been said so far can be summarized as follows:

The *gravitational field* of a geometric mass m is defined as the stationary, spherically symmetric state which is caused by the fact that, if $m > 0$ (in the case of matter) *any distance from the center O* is by m units smaller – or, if $m < 0$ (antimatter), by m units greater – than in the flat continuum. This metric alteration causes a *radial flow* $v(r)$ which is real or imaginary. (The circumferences of circles around O remain unchanged.)

The *electromagnetic field* of a central geometric charge μ is defined as the spherically symmetric state which is caused by the fact that, if $\mu > 0$ (in the case of positive charge) *the circumference of any circle around O* is by $2\pi\mu$ units *shorter* – or, if $\mu < 0$ (in the case of negative charge) by $2\pi\mu$ units *longer* – than in the flat continuum. This metric alteration causes a *flow* $w(r)$ *that rotates circularly around the center O* and which is real or imaginary. (Radial distances remain unchanged.)

5.4. Positive and negative Charge

In the metric dynamic model, the relationship between positive and negative charge is analogous to the relationship of matter and antimatter. The metric deformations are in both cases opposite to each other. Thus it can be geometrically understood why the consequences of positive and negative charge cancel each other out.

In the case of matter and antimatter, the metric alterations relate only to the radial distances r , in the case of positive and negative charge, they relate only to the arc lengths $r\phi$.

The following applies to S' and therefore also to S_F that has the same differential measures as S' :

If, according to (45), positive charge is defined by
$$r d\phi_F = \left(1 - \frac{\mu}{r}\right)^{-1} r d\phi \quad (\mu > 0)$$

– with the consequence that to the circumference U_F of a circle around O in the continuum altered by the charge μ applies:

$$U_F(r) = 2\pi(r - \mu)$$

– then the equally large negative charge is defined by

$$r \, d\phi_F = \left(1 + \frac{\mu}{r}\right)^{-1} r \, d\phi$$

from which follows $U_F(r) = 2\pi(r + \mu)$

As was the case with matter and antimatter, the squares of the metric flows (of positive and negative charge) cancel each other out:

$$\text{Positive charge: } w_{\text{pos}} = \pm \sqrt{\frac{\mu}{r}}$$

$$\text{Negative charge: } w_{\text{neg}} = \pm i \sqrt{\frac{\mu}{r}}$$

$$\text{Therefore: } w_{\text{pos}}^2 + w_{\text{neg}}^2 = 0$$

5.5. The Transition to an Observer System

Exactly in the same way as in the description of gravity, a local system S_F in the flow can be used as basis for the transition to a (relativistic) observer system S_R .

According to (47) and (48), a local system S_F that rotates with the flow is characterized by

$$S_F: (dt_F = dt, \, dr_F = dr, \, d\phi_F = \left(1 - \frac{\mu}{r}\right)^{-1} d\phi) \tag{49}$$

Only the arc differential is altered. (The arc differential $r d\phi_F$ is identical with the length differential of the local flow system S_F .) The radial distances remain unchanged. The time in the flow is always the same, and it corresponds to the time outside of the field.

Now from S_F (i.e. from the neighborhood of any point P in the flow with $PO > \mu$) can be transformed to a local observer system S_R that is not rotating but resting relative to O.⁸¹ The transformation factor is that of the Lorentz-Transformation

$$k = \sqrt{1 - w^2} = \sqrt{1 - \frac{\mu}{r}} \quad (50)$$

S_R moves with velocity $-w$ relative to S_F . Thus the length differential of S_F must be multiplied by k , and the time differential must be divided by k .

Then follows for the (tangential) length differential $r d\phi_R$ of S_R

$$\begin{aligned} r d\phi_R &= r d\phi_F k = r d\phi \left(1 - \frac{\mu}{r}\right)^{-1} \left(1 - \frac{\mu}{r}\right)^{\frac{1}{2}} = r d\phi \left(1 - \frac{\mu}{r}\right)^{-\frac{1}{2}} \\ r d\phi_R &= r d\phi \left(1 - \frac{\mu}{r}\right)^{-\frac{1}{2}} \end{aligned} \quad (51)$$

and for the time differential dt_R

$$dt_R = dt \left(1 - \frac{\mu}{r}\right)^{\frac{1}{2}} \quad (\text{note: } dt_F = dt) \quad (52)$$

The radial differential dr remains unchanged.

⁸¹ Here, the intermediate step to a *relativistic* flow system, which was required in the description of gravity, can be dispensed with, because the factor 2 that is substantiated by this step does not appear at all under the conditions of the hybrid system. (See 2.6.)

From (51) follows that, with respect to a resting observer, to the circumference U_R of a circle around the center O applies:

$$U_R = U \left(1 - \frac{\mu}{r}\right)^{\frac{1}{2}} \quad (53)$$

From (52) follows that the transversal (here rotating) metric flow $w(r)$ of the electromagnetism changes the passing of time in the same way as does the radial metric flow of gravity:

For an observer who rests relative to O at a distance r from O , in the case of positive charge the passing of time is retarded by the factor k of (50). In the case of negative charge, in (50) and (52) applies $\mu < 0$ and the passing of time is accelerated. If positive and negative charges are equally large, then the squares of the metric flows that cause the time alterations cancel each other out, and the time is again equal to the time outside of the field.

5.6. The fundamental Difference between Gravitation and Electromagnetism

With respect to all hitherto deduced facts and laws, gravity and electromagnetism appear strictly analogous to each other. Now we turn to an important difference of the two interactions, in fact exactly *that* difference which is the reason why they seem to be incompatible in the usual view. As follows:

In the case of gravity, the radial metric change of the continuum results in a radial metric flow, which is *accelerated* towards the center. This acceleration itself corresponds already to the Newtonian approximation. The complete concept of gravity contains additionally also the assumption of waves in the accelerated flow.

Therefore, gravity acts *by the accelerated flow itself*. In this sense it can be asserted that gravity *is* the accelerated flow.

In the case of electromagnetism, the circumferential metric change of the continuum results in a metric flow that rotates around the center. This flow increases with decreasing distance from the center, however it is *constant* for any specified distance.

Therefore, electromagnetism *cannot act directly via the flow*.

So *how* does it work? – There is actually only one possibility: its effects must be mediated by waves that occur in connection with the respective metric-dynamic field, which means: by electromagnetic waves. Apparently, this corresponds to the usual notion of the interaction.

(However the interpretation changes in accordance with the assumptions of the local and objective interpretation of quantum mechanics presented in the First Part. There, the Photoelectric Effect and the Compton Effect were described by the simplest model of such an interaction. The main point was: photons are not particles. With respect to electromagnetism, this means: the "virtual" photons have no equivalent in the reality.)

With this, it is also explained why the electromagnetic interaction can be isolated, whereas this is impossible with respect to gravity: The paths of the waves, through which the electromagnetic interaction is mediated, can be interrupted.

But this does not apply to the flow: it comes *before* anything that exists, such that it flows through everything. Thus it cannot be shielded. This is also the reason why, even in the case of total electromagnetic isolation, nonetheless in the charge-free space observable phase-shifts of electron matter waves occur: this is exactly the effect which must be expected due to the rotating flow of the electromagnetism. And since, as mentioned just before, gravity *is* the flow, it is evidently impossible to isolate it.

Thus, the different mechanism of action of the two interactions follows directly from their definition. In spite of their common origin at the fundamental law (1), the one manifests itself directly as acceleration, whereas the other one is mediated by waves.

Note: In the definition (43) of the steady state "charge" by $\eta = \frac{r - \mu}{r}$, the metric angle density η depends on r . Thus, according to equation (2) $\frac{d\eta}{dr} = -\frac{dw}{dt}$, there should be a change of the flow velocity w with time. Why doesn't it occur in our scenario?

In the outline (S4) in section 1.4 can be seen that the angle change is different on both sides of r ; only then follows an acceleration normal to r . However at the metric alteration, which is caused by a central charge, this is not the case (see (S15) and the attached comment). The metric changes are identical at *all* planes through O , and the flow is equally large in all tangential directions.

5.7. *The Purpose of the subsequent Considerations*

I shortly interrupt the train of thought just to point out what exactly the purpose of the whole action is.

It is neither about establishing a theory that is in competition with quantum mechanics, nor about deriving quantum mechanics once again. As with the interpretation of quantum theory in the First Part, also here it is intended to reconstruct the experiences, which gave rise to the theory, from a different point of view, in order to interpret them differently based on this reconstruction and, in this way, to *understand* them.

Due to the simplicity of the resources used, the results of the following sections correspond to those of the "old" quantum theory, which mainly Bohr and Sommerfeld contributed to. However for the intended target, this is not a disadvantage; on the contrary – precisely in this way we are returning to the original historic scene, so to speak exactly at the spot where the physics that had developed from experiences with objects hit the atomic facts and was not able to interpret them – or say: could only describe them by a mathematical scheme at the price of losing any possibility of understanding what is actually going on there.

If we now arrive at this very point on our way, the situation is completely different: We are not equipped with models, the concepts of which originate from mechanics and must necessarily fail here, but with the concepts flow and metric, and it will turn out that, on this basis, the atomic facts either follow almost by themselves or at least can be deduced in an altogether understandable way.

Think e.g. about the question of the "permitted paths" or states. In the historical development, Bohr decided this question at first so to speak "via enactment", before de Broglie explained it by assigning wave-attributes to the particles – where however the term "explanation" seems problematical, because this is again the step into absurdity: into dualism, uncertainty etc.

In the metric dynamic model, these "permitted paths" are a matter of course.

Moreover, it is evident that there are *actually* no "paths" – the particle does indeed not exist – and that, accordingly, in the case of states with angular momentum 0 nothing at all rotates. (Such states could not be represented in the Bohr-Sommerfeld model.)

Also the connection between angular momentum and number of node plains of the respective state, which is unexplainable within the frame of post-mechanical concepts, can easily be derived and understood on the basis of our assumptions. Basically, it is an analogy to the connection between

momentum and inverse wave-length that was cleared up in the First Part using the example of the Photoelectric Effect and the Compton Effect. In the same way as could be seen there why and how momentum is connected with propagating waves, it can be understood here why angular momentum must be assigned to spherical harmonics.

Also the quantization becomes evident, and at the same time the fact that it appears in the form of integer multiples of a fundamental unit.

The spin can be reconstructed and understood in the metric dynamic model too, and the same applies to the three other quantum numbers.

As last point of this short preview, it should be mentioned that all these reconstructions can be carried out for any atomic number.

How will the reconstructions be performed? By using the metric-dynamic description of the field of a positive charge $\mu > 0$ in order to determine the possible stationary wave states within this field.

(From now on, only relativistic reference systems will be used. The system that rests relative to O – previously denoted S_R – will be called S' , and the system that rotates with the flow still S_F .)

5.8. States of the Hydrogen Atom

Let S' be the system that rests with respect to a central positive charge $\mu > 0$. Let S_F be the system the points of which rotate with the velocity $w(r)$ around O. (S_F is the flow system.)

To determine the possible stationary wave states within the field of a positive charge $\mu > 0$, the following prerequisites are needed:

$$a) \quad r d\varphi' = r d\varphi \left(1 - \frac{\mu}{r}\right)^{\frac{1}{2}}, \quad dt' = dt \left(1 - \frac{\mu}{r}\right)^{\frac{1}{2}}$$

$$b) \quad r d\varphi_F = r d\varphi \left(1 - \frac{\mu}{r}\right)^{-1}, \quad dt_F = dt$$

$$c) \quad w(r) = \pm c \sqrt{\frac{\mu}{r}}$$

To the circumference $U(r)$ of a circle with radius r around O , measured in the system S' , applies according to a)

$$U(r) = 2\pi r \left(1 - \frac{\mu}{r}\right)^{\frac{1}{2}}$$

Seen from S_F , the same circle has, according to b), the circumference $U_F(r)$:

$$U_F(r) = 2\pi r \left(1 - \frac{\mu}{r}\right)$$

Here is an outline. It shows an arbitrary plane through O . (For w , one of the two possible directions is chosen.)

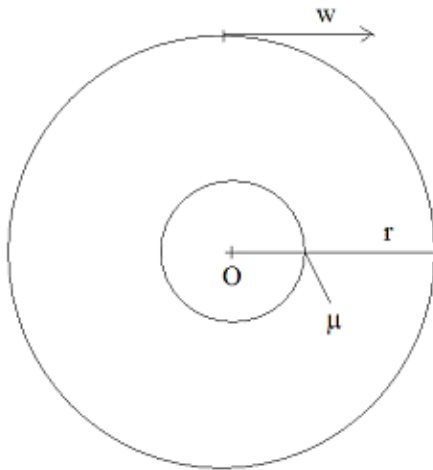

(S16)

So much to the prerequisites as regards the field.

(In the following, the factor k stands again for: $k = \sqrt{1 - \frac{w^2}{c^2}} = \sqrt{1 - \frac{\mu}{r}}$)

As a further prerequisite serves a metric dynamic fact derived in the previous chapter:

The existence of a particle is connected with the occurrence of an in-phase oscillation on the surface of a sphere, the frequency of which is equal to the frequency f of the particle.

(The frequency f is the one that, in standard-physics, is related to the energy of the particle by the equation $E = hf$.)

Now we look at an electron. The geometric mass be m_e , the according frequency f_e . We imagine this electron placed into the field of a positive charge μ .

At first it must be cleared up what it means, seen from our viewpoint, "to place an electron into the field of a positive charge μ ". Here, the electron is not a "particle" in the usual sense, because there are only metric alterations, flows and waves. Therefore it would be inappropriate to apply a mental image like in Bohr's atomic model:

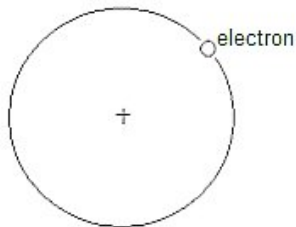

(S17)

– which means: to let the electron circle around the nucleus.

Instead we act – exactly as in the First Part – on the following assumption, – or say: working hypothesis:

The electron is an oscillation state of an area of the continuum.

Then placing the "electron" into the field of the "proton" means connecting the two states of the continuum, that is: to superimpose one on the other, as indicated in the next outline:

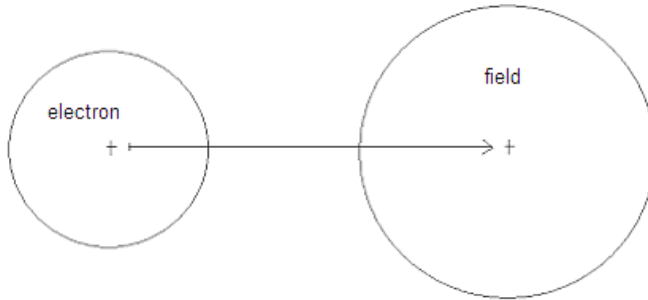

(S18)

So the question to be answered is:

What follows in regard to the in-phase oscillation on the spherical surface connected with the existence of the continuum state called "electron", if this state is superimposed upon an area of the continuum that is altered by a geometric charge $\mu > 0$?

The following sections will show whether our assumption regarding the electron is suitable.

In the first step, it will lead us to the ground state of the hydrogen atom.

The Ground State

Let us at first discuss the conditions of the field by looking at an arbitrary plane through O. The "electron" is in the field. This means: in this plane an in-phase oscillation exists on a circle around O.

With respect to the rotating flow-system S_{F_2} the phase coincidence of the oscillation is canceled, that is: with respect to S_F a *phase wave* exists. The wave-length of this phase wave provides for the condition, from which then ensues the radius r_1 of the simplest stationary oscillation state of the electron.

This condition reads as follows:

With respect to the flow system S_{F_2} the wave length of the phase wave is equal to the circumference of the circle with radius r_1 .

In S_F , the lengths are altered. Therefore, the connection between S_F and S' does not correspond to the connection between two reference systems of the special theory of relativity. So we cannot simply carry out a Lorentz transformation. Thus the simplest way to determine the phase differences with respect to S_F is to directly go back to the relativistic definition of time by light. (For an explanation see 2.8. from the First Part.)

The following outline illustrates the conditions by which the time shifts can be determined that apply to an observer in S_F compared with an observer in S' :

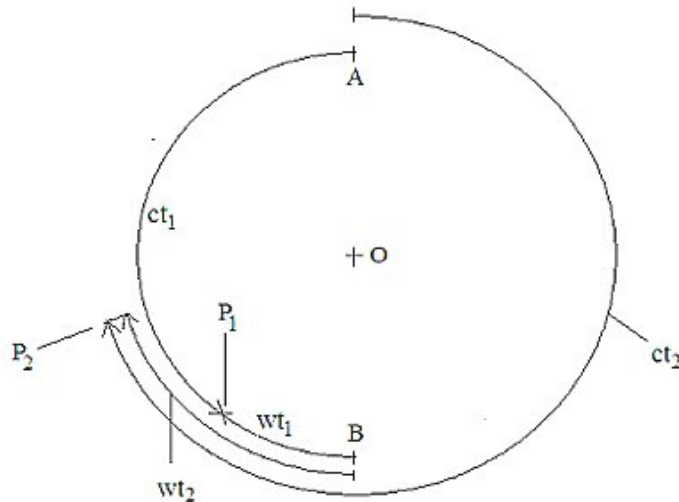

(S19)

From A light signals are emitted into both tangential directions. If they propagate along the circle, they arrive simultaneously at an observer in S' , who is resting at B. At an observer in S_F , who at the time of the emission of the signals is also at B and moves with velocity w along the circle, the one light signal arrives at point P_1 at the time t_1 , the other one at P_2 at the time t_2 . Therefore, the time points of the emission of the signals **are** different with respect to the moving observer by $\Delta t = t_2 - t_1$. Thus the time difference Δt corresponds to the phase shift per circumference with respect to the moving observer.

As can be seen in (S19), it holds that:

$$ct_1 + wt_1 = U_F/2 \quad ct_2 - wt_2 = U_F/2$$

$$\Delta t = t_2 - t_1 = \frac{U_F/2}{c-w} - \frac{U_F/2}{c+w}$$

From this follows $\Delta t = U_F \frac{w}{c^2} \left(1 - \frac{w^2}{c^2}\right) = U_F \frac{w}{c^2} \frac{1}{k^2}$

Because of $U_F(r_1) = 2\pi r_1 \left(1 - \frac{\mu}{r_1}\right) = 2\pi r_1 k^2$

applies $\Delta t = 2\pi r_1 \frac{w}{c^2}$ (54)

This time difference must be set equal to one period of the oscillation. Since in S_F the time is identical with the time outside of the field, the frequency of the oscillation is f_e with respect to S_F , and accordingly the period is $1/f_e$.

With this, the radius r_1 can be derived. We start at

$$\Delta t = 1/f_e \quad (55)$$

$$2\pi r_1 \frac{w}{c^2} = \lambda_{Ce} \frac{1}{c} \quad (\lambda_{Ce} \text{ is the Compton wave-length of the electron: } f_e \lambda_{Ce} = c)$$

$$2\pi r_1 = \lambda_{Ce} \frac{c}{w} \quad (56)$$

$$r_1 = \lambda_{Ce} \frac{c}{w} \quad (56')$$

With $\frac{c}{w} = \sqrt{\frac{r_1}{\mu}}$ follows

$$r_1 = \frac{\tilde{\lambda}_{Ce}^2}{\mu} \quad (57)$$

Here, $\tilde{\lambda}_{Ce}$ is the geometric mean of r_1 and μ . (compare (41) und (41'))

If now the geometric charge μ is set equal to the classical electron radius r_e

$$\mu = r_e \quad (58)$$

– then r_1 is equal to the Bohr-radius, and (57) turns into the well-known equation:

$$r_B = \frac{\tilde{\lambda}_{Ce}^2}{r_e} = \tilde{\lambda}_{Ce} \frac{\tilde{\lambda}_{Ce}}{r_e} = \tilde{\lambda}_{Ce} \frac{1}{\alpha} \quad (57')$$

Thus, because of (58), μ becomes the ***geometric elementary charge***.

Here is a (logarithmically scaled) outline of the conditions in the tangential flow w:

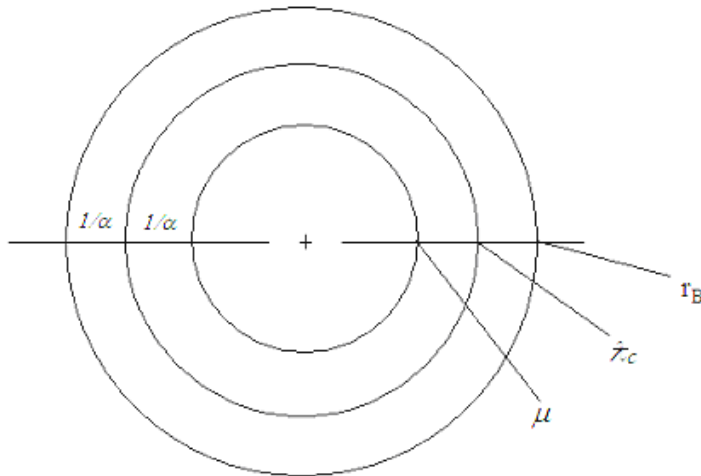

(S20)

In the metric dynamic model, the relationship between the three quantities classical electron radius (which here is the geometric elementary charge μ), the Compton wave-length of the electron and the Bohr radius is mediated by the rotating metric flow.

Up to now, the description was limited to the conditions on a plane. However anything hitherto derived applies to *any* plane through the center. This means that an in-phase oscillation with the frequency of the ground state of the hydrogen atom exists not only on a *circle* with radius r_B around O, but on a *spherical surface* with radius r_B .

If an electron is positioned into the field of a positive charge μ , then a state results, in which – on a spherical surface the radius of which is equal to the Bohr radius – an in-phase oscillation exists.

The question is: Does this state correspond to the ground state of hydrogen?

This depends on the extent to which the attributes of this state, which ensue from the metric dynamic field definition, correspond to the known attributes of the ground state.

So let us determine further attributes of this state.

The Frequency of the Ground State

From the metric dynamic point of view, the frequency f_e' of the (with respect to S' equiphase) oscillation at the distance r_B follows from the fact that, in S', the time at the distance r_B is retarded by the factor

$$k = \sqrt{1 - \frac{w^2}{c^2}} = \sqrt{1 - \frac{\mu}{r_B}}$$

Therefore applies:

$f_e' = f_e k$	(59)
----------------	------

The standard value f_e' of the electron in the ground state of hydrogen is

$$f_e'/f_e = 1 - \frac{\alpha^2}{2} \quad (60)$$

Let us compare $f_e'/f_e = k = \sqrt{1 - \frac{\mu}{r_B}}$ with this value:

It holds that $\frac{\mu}{r_B} = \alpha^2$, and therefore

$$f_e'/f_e = \sqrt{1 - \alpha^2} = 1 - \frac{\alpha^2}{2} + \frac{\alpha^4}{8} - \dots \approx 1 - \frac{\alpha^2}{2} \quad (61)$$

Thus, the metric dynamic value of f_e'/f_e in (61) is slightly different from the standard value in (60) ($\alpha^4/8 = 3.54 \cdot 10^{-10}$). Here, the standard value appears as a non-relativistic approximation.

The Spin in the metric dynamic System

To any point P on the spherical surface with radius r_B , where an in-phase oscillation with frequency $f_e' = f_e k$ exists, must be assigned the velocity $w(r_B)$ at any direction on the tangential plane defined by P.

On any planar section through the center of the sphere, there are exactly two possibilities in regard to the flow-quantity $w(r)$ at the distance r_B :

$$w = \sqrt{\frac{\mu}{r_B}} \quad \text{and} \quad w = -\sqrt{\frac{\mu}{r_B}}$$

The fact of a rotation at any plane, the size of which is fixed and which has exactly two possibilities, corresponds to the definition of the spin.

Therefore, we will use the flow-quantity $w(r_B)$ for the definition of a quantity that represents the metric dynamic analogue to the spin of quantum mechanics.

The quantum mechanical spin has the dimension of a an angular momentum Θ , where

$$\Theta = M r w \quad (M \text{ is the "normal" mass, } w \text{ is the tangential velocity})$$

In the metric dynamic system, there are only lengths and times and no other measures. Instead of introducing further unities, we define, analogously to the spin:

$$S_{md} = m_e r_B w_{r_B} \quad (m_e \text{ geometric mass of the electron, } w \text{ means } w/c)$$

$$w_{r_B} = \pm \sqrt{\frac{\mu}{r_B}}$$

$$S_{md} = \pm m_e r_B \sqrt{\frac{\mu}{r_B}} = \pm m_e \sqrt{\mu r_B}$$

According to (57): $\sqrt{\mu r_B} = \tilde{\lambda}_{Ce}$

Therefore: $S_{md} = \pm m_e \tilde{\lambda}_{Ce}$

According to (41''): $m_e \tilde{\lambda}_{Ce} = \tilde{\lambda}_{Pl}^2$, such that finally

$S_{md} = \pm \tilde{\lambda}_{Pl}^2$	(62)
---------------------------------------	------

Thus the metric-dynamic spin is equal to the square of the fundamental length. (That this length appears squared is just a consequence of the definition of the metric dynamic spin.)

This corresponds to the quantum mechanical identity of spin and quantum of action – only the factor 1/2 has been lost. However it is somehow "not far away", if one thinks of the fact that, in the case of negative charge $\mu < 0$, the circumference of a circle with radius $r = |\mu|$ is equal to $4\pi|\mu|$, such that a full circle corresponds to an angle of 720° – which is exactly the condition which, in quantum mechanics, relates to the half-integer spin.

At the just performed derivation of the value of the spin, it can be seen how at first the relation between the three quantities $[\mu | \lambda_{Ce} | r_B]$, which is mediated by the tangential flow $w(r)$, and then the relation between the three quantities $[m_e | \lambda_{Pl} | \lambda_{Ce}]$, which is mediated by the radial flow $v(r)$, together make it possible to trace back the spin to the fundamental length.

Here is an outline, again logarithmically scaled (but still not true to scale):

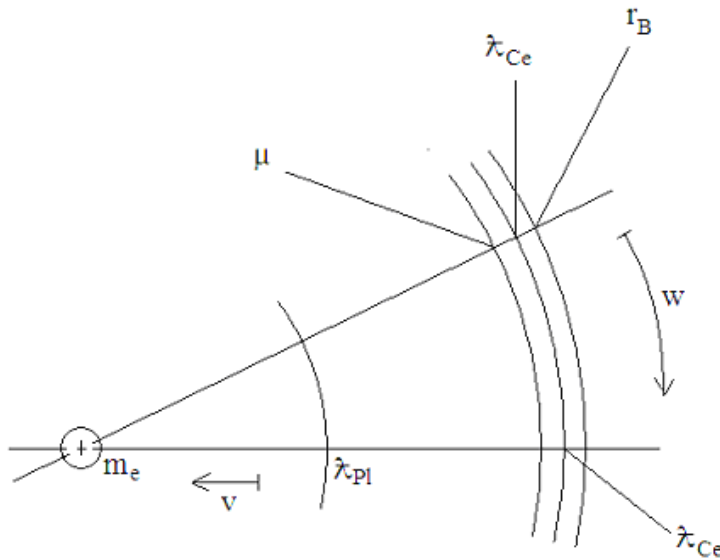

(S21)

As a reminder: According to (42') applies

$$m_e Z'_E = \lambda_{Pl} \quad \text{and} \quad \lambda_{Pl} Z'_E = \lambda_{Ce} \quad \text{with} \quad Z'_E = 2.390 \cdot 10^{22}$$

– and, according to (57) and (57')

$$\mu \frac{1}{\alpha} = \hat{\lambda}_{ce} \quad \text{and} \quad \hat{\lambda}_{ce} \frac{1}{\alpha} = r_B \quad \text{with} \quad \frac{1}{\alpha} = 137.036$$

Interpretation of the Spin

Now we will investigate the meaning of the fact that there is a rotation *on any plane*, the value of which is fixed and for which there are exactly two possibilities.

Let us briefly return to the first law. It reads:

$$\frac{d\sigma}{dr} = \pm \frac{1}{c^2} \frac{dv}{dt}$$

I said at this point: "This is the law, from which reality is woven."

Although this is expressed poetically, it is still meant to the point: *for us*, this law acts *in space*, but *in itself*, there is no such space – the continuum arises only through the action of this law, it is *actually woven from it*.

In the case of gravity, the development process is 1-dimensional: the continuum is composed of *flow lines*. Let us look, for the sake of simplicity, at the spherically symmetric case. Here, the continuum consists of radii – of rays that emanate from the center (or end in it). To these radii, certain metric attributes are assigned, and to the points located on them the according flow velocities. The condition, which is imposed on these one-dimensional regularities, is consistency: the 3-dimensional continuum, which is formed from these 1-dimensional laws, must not contain contradictions.

Since electromagnetism is assigned to the metric angle density, here the construction is 2-dimensional: the continuum is composed of *surfaces* that go through the center O – let us call them M-surfaces. Therein is nothing peculiar, it is just as natural as composing the continuum of lines.

In the spherically symmetric case, the surfaces are planes through the center. To these planes again metric attributes are assigned, and to the points located on them flow velocities. The condition is again that no inconsistencies must occur in the composition of the planes to a three-dimensional continuum.

If these M-surfaces through O are composed to a 3-dimensional continuum, then other surfaces emerge – say R-surfaces (in the spherically symmetric case, they are spherical surfaces) –, which are defined by the condition that to any point on the surface the same flow velocity is assigned, in fact *in any tangential direction* on the surface.

The point, which is decisive for understanding this statement, is the fact, that it is a *statement about the continuum*. As such, it is neither absurd nor contradictory: it is just about assigning velocities to points. Actually, *nothing* moves – a point of the continuum is not an abstraction of something existing.

However if one tries to interpret the velocity and the according rotation as *attribute of an object* – as is usually done in order to demonstrate the impossibility to understand quantum mechanical quantities other than mathematically – then the circumstances turn into absurdities, and, accordingly, it would indeed be proven that quantum mechanical objects are inaccessible to our thinking.

From the metric dynamic viewpoint, the following applies:

In the case of electromagnetism, the continuum consists of R-surfaces, to any point of which is assigned a flow velocity at any tangential direction. The surfaces are defined by the fact that the absolute value of this velocity is identical for all points of the surface.

These circumstances represent *attributes of the continuum*. They are *not* attributes of an object.

However the metric dynamic attributes of the continuum defined in this way now represent the necessary condition for the development of stationary wave states.

Only these wave states can be understood as "objects". Thus they contain the flow velocity not *as attribute*, but *as precondition*.

In the above section "The ground State", these facts can be seen clearly. There, an in-phase oscillation exists on the surface of a sphere. This oscillation state is the "object". The object has neither the attribute "flow velocity" nor does it rotate. Flow velocity and rotation are attributes of the continuum, and they are necessary conditions for the existence of the in-phase oscillation.

If one approaches the quantum mechanical objects coming from the side of the *things*, then the only possibility is to interpret the quantities, which are needed for the description, as attributes of things – and to fail with this attempt at interpretation.

But if, on the contrary, one starts the description of the world with the *preconditions of being*, then one is at first confronted with the necessity to reconstruct *things*. The quantities needed for that do not yet belong to the realm of objects. Thus, from this viewpoint, it is evident that they are prerequisites and not attributes of objects.

I close my remarks on the interpretation of the spin by quoting myself:

"That which is described by quantum mechanics lies on the border between the pre-objective and the objective realm. Only as seen in this way – by looking at it from both sides – a quantum object can be understood and interpreted realistically." (First Part, section 3.9, point 3.)

Excited States; Quantum Numbers

In order to keep the reconstruction of the first quantum mechanical state as simple as possible and to highlight the metric dynamic substantiations, I described the inner spherical surface, where a phase coincidence occurs, a bit more in detail and separately from the outer surfaces with in-phase oscillations. Actually, however, this separation is not justified, since the derivation of the radii of these surfaces is analogous to the derivation of the Bohr radius, which has just been performed in the section "The Ground State".

We are looking for the radius r_n of the n^{th} spherical surface, where an in-phase oscillation exists, and for the frequency $f_e(r_n)$ of this oscillation.

Again we begin with the fact that the in-phase condition at the spherical surface, which is caused by the geometric mass m_e of the electron, is canceled in the flow due to the rotation, which means that with respect to the rotating system S_F a phase wave exists.

The condition, which represents the basis of the calculation, is now that the circumference of the circle with radius r_n is, with respect to S_F , equal to n times the wave-length of this phase wave.

We start again with the phase difference Δt that occurs with respect to S_F . Analogously to (54) applies:

$$\Delta t = 2\pi r_n \frac{w}{c^2} \quad (63)$$

However now instead of (55) $\Delta t = 1/f_e$,

for the n^{th} spherical surface applies:

$$\Delta t = n / f_e \quad (64)$$

– because now the radius of the circle is to be determined, whose circumference is equal to n times the phase wave length, and therefore Δt must be equal to n periods of the oscillation. (Note that the phase wave exists only with respect to the rotating flow-system S_F ; with respect to the non-rotating system S' , there is no phase shift but again simply an in-phase oscillating spherical surface with radius r_n .)

With $\Delta t = 2\pi r_n \frac{w}{c^2}$ follows

$$2\pi r_n \frac{w}{c^2} = n \lambda_{Ce} \frac{1}{c} \quad (\lambda_{Ce} \text{ Compton wave-length of the electron, } f_e \lambda_{Ce} = c)$$

$$2\pi r_n = n \lambda_{Ce} \frac{c}{w} \quad (65)$$

$$r_n = n \lambda_{Ce} \frac{c}{w} \quad (65')$$

With $\frac{c}{w} = \sqrt{\frac{r_n}{\mu}}$ follows

$$r_n = n^2 \frac{\lambda_{Ce}^2}{\mu} \quad (66)$$

$$r_n = n^2 \lambda_{Ce} \frac{1}{\alpha} = n^2 r_B \quad (67)$$

The associated frequency $f_e(r_n)$ follows from

$$f_e(r_n) = f_e \sqrt{1 - \frac{\mu}{r_n}} = f_e \sqrt{1 - \frac{\mu}{n^2 r_B}} = f_e \sqrt{1 - \frac{\alpha^2}{n^2}}$$

$$f_e(r_n) / f_e = \sqrt{1 - \frac{\alpha^2}{n^2}} = 1 - \frac{\alpha^2}{2n^2} + \frac{1}{8} \frac{\alpha^4}{n^4} - \dots$$

This is, except for the terms of higher order $\frac{1}{8} \frac{\alpha^4}{n^4} - \dots$ identical with the usual value:

$f_e(r_n) = f_e \left(1 - \frac{\alpha^2}{2n^2} \right) \tag{68}$
--

n is the principal quantum number.

The hitherto described states are phase coherent. There is no rotation – the "orbital angular momentum" is 0. However there are also states with angular momentum $\neq 0$. Now we turn to these states.

At first we must define the metric dynamic analogue L_{md} of the orbital angular momentum $|L|$. Analogously to the procedure with the spin, we define:

$$L_{md} = m r v_t \tag{69}$$

Here, m is again the geometric mass, r is the distance from the center of rotation, v_t is the tangential velocity (read v_t/c).

First, a preliminary consideration: The result of the previously performed derivation was that on a circle with radius $n^2 r_B$ an in-phase oscillation exists, i.e. an oscillation without node points.

On this circle, however, also states *with* node points are possible – but only if these nodes *rotate* with respect to S'.

Let us assume, the velocity at which the nodes – in other words: the oscillation state itself – propagate along the circle, is $w(r_n)$. If we multiply (65) by k , then the left side of the equation represents the length of the circumference of the circle with respect to S', and the right side represents the number of the waves times the phase wave length:

$$2\pi r_n k = n \left(\lambda_{ce} \frac{c}{w(r_n)} k \right)$$

This means: If the velocity of the node points is equal to the rotation speed of the flow $w(r_n)$, then follows that, with respect to S', a phase wave exists with n wave lengths per circumference. (With respect to S_F, the oscillation is in-phase.)

In general, the following applies: The wave-length of the phase wave in a resting system, which, due to the Lorentz-Transformation, emerges from an in-phase oscillation with frequency q in a system moving at velocity v , is equal to $(c / q) (c / v) k$. From this follows, that the wave-length is approximately inversely proportional to the velocity v . (Only approximately, because k depends on v .)

Therefore, if, at a rotation speed equal to the flow velocity $w(r_n)$, the number of waves per circumference is equal to n , then, for a phase wave with *one* wave per circumference, a rotation speed of $w(r_n)/n$ is needed.

And thus, finally, the precondition for the existence of a phase wave with l waves per circumference is, that the speed v_t at which the nodes rotate, must be equal to $l w(r_n)/n$.

Let us now substitute in (69):

$$L_{md} = m r v_t$$

For the geometric mass m must be set m_e , r is r_n , $v_t = l w(r_n)/n$.

This leads to: $L_{md} = m_e r_n l w(r_n)/n$

$$\text{Now } r_n = n^2 r_B, \quad w(r_n) = \sqrt{\frac{\mu}{n^2 r_B}}$$

From this follows:

$$L_{\text{md}} = m_e n^2 r_B l \sqrt{\frac{\mu}{n^2 r_B}} \frac{1}{n}$$

$$L_{\text{md}} = l m_e \sqrt{\mu r_B} \quad \mu r_B = \tilde{\lambda}_{\text{Ce}}^2 \quad (57)$$

$$L_{\text{md}} = l m_e \tilde{\lambda}_{\text{Ce}} \quad m_e \tilde{\lambda}_{\text{Ce}} = \tilde{\lambda}_{\text{pl}}^2 \quad (41'')$$

And therefore, finally

$$L_{\text{md}} = l \tilde{\lambda}_{\text{pl}}^2 \quad (70)$$

l is the orbital angular momentum quantum number.

For comparison: The quantum mechanical value of the orbital angular momentum is

$$|L| = (l(l+1))^{1/2} \hbar$$

There is a fundamental difference between spin and orbital angular momentum. The spin is an *attribute of the continuum* and, therefore, a *precondition* of the object "oscillation state".

In contrast, the orbital angular momentum follows from the assumption, that *the oscillation state itself rotates*, which means: it is an *attribute of the object*.

In the case of a state *without* orbital angular momentum, it is possible to assemble the in-phase oscillations along the circles with radius r_n at all planes through O to a total in-phase oscillating spherical surface.

However in the case of a state *with* an orbital angular momentum $\neq 0$, there are node points, which move along the circumference with the velocity $v_t(l)$. If one now assumed the same rotation at all planes through O, it would be impossible to assemble the circles on all planes to an oscillating spherical surface.

This means: In the case of a state with orbital angular momentum $\neq 0$, at the transition from the circle-oscillation to the spherical surface-oscillation, the spherical symmetry of the continuum-state is broken. Other than the spin, which is an attribute of the spherical symmetric continuum-state and has therefore the same value with respect to *any* plane or of any rotation axis, the orbital angular momentum is an object attribute and exists therefore always only with respect to a given direction.

Based on the hitherto performed conclusions, we have arrived at the idea of a spherical surface on which there is a wave with l nodal lines, and which, at the same time, rotates in a definite direction.

As an example, here is an illustration of the state with $n = 4$ and $l = 3$:

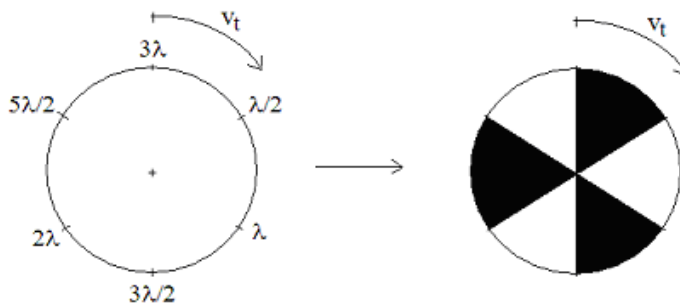

(S22)

Here, if one proceeds from the view at a plane (to the left) to a spatial view (to the right). then the oscillation state of the circle turns into the oscillation state of a spherical surface, which rotates with the tangential velocity $v_t(l)$. The 6 node points along the circle turn into 3 node lines on the spherical surface. The areas of positive amplitude values are displayed in black, the areas of negative values in white.

The angular momentum of the state on the right side of the outline corresponds to the angular momentum of the quantum mechanical 4f-state depicted in the following outline:

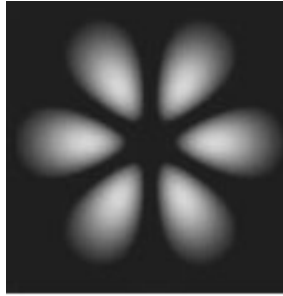

(S23)

(In (S23), all oscillation areas appear white, because here the squares of the amplitudes of the wave function are depicted.)

The transition from the oscillating circular line to the oscillating spherical surface can also be carried out in another way as in the outline (s22); e.g. like in this outline:

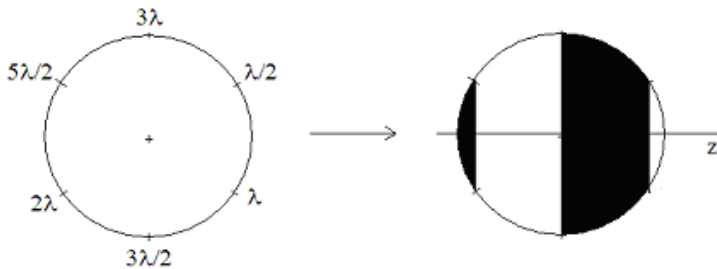

(S24)

Here, all planes defined by node lines are parallel to each other and normal to a given direction. In the outline, this is the direction parallel to the arrow. Let us call this direction z , as usual. From the derivation of (70) follows, that the rotation speed is proportional to the number of the nodes, which occur on the plane through O and normal to the rotation axis. Since in (S24), the number of the nodes on the plane through O and normal to z is equal to 0, there is no rotation with respect to z .

This leads us to the *fourth quantum number* m :

m denotes the number of the planes which are defined by node lines and which are *not* normal to z . Thus, in (S24), $m = 0$, and the state on the right side of the outline (S24) can be identified with the $4f$ ($m=0$) state in the following outline:

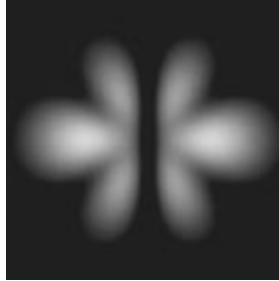

(S25)

(Also here all oscillation areas appear white, because the outline shows the squares of the amplitudes of the wave function.)

At any given number of nodes l , the number of possible m -states must be equal to $2l + 1$; it follows directly from the number of the possibilities, to arrange – in the case of l node lines in total – m of the planes defined by them in parallel to each other and normal to z , and from the fact that, for $m \neq 0$, there are always two rotation directions with respect to z .

The speed at which the spherical surface rotates around the z -axis – and the according angular momentum – depend on the number of the planes defined by node lines, which are not normal to z . Thus the angular momentum with respect to z depends on m .

This corresponds to the quantum mechanical precepts.

The general scheme is evident: the total number of nodes is determined. At the transition from the view at a plane to a spatial interpretation, the symmetry of the continuum state is broken, and the possible oscillation states of a spherical surface with l node lines must be determined.

In this way, the orbital angular momentums of all quantum mechanical states of the hydrogen atom can be constructed.

Up to now, we have only investigated the phase conditions on planes with radii $n^2 r_B$, which are characterized by the fact that the phase wave interferes *constructively*. However it is evident that the phenomenon "electron in the field of a positive charge μ " is a *three-dimensional* oscillation state. So, let us at last take a look at the "inside" of a state A, which is characterized by the quantum numbers n_A, l_A .

The surfaces with radii $n^2 r_B$ ($1 \leq n \leq n_A$) must be understood as those surfaces where the amplitude of the three-dimensional oscillation state has its maximum. In the case of the state A, the surface with radius $n_A^2 r_B$ is obviously the outermost of these surfaces.

How many such surfaces with maximum amplitude are there within the state A? At first it appears as if the answer were simply $n_A - 1$. However the following consideration shows that, for $l_A > 0$, not all spherical surfaces with radius $n^2 r_B$ are permitted. As follows:

The (metric-dynamic) angular momentum of A is $l_A \hbar \lambda_{pl}^2$. Thus it depends only on l_A . We derived it from the phase conditions on the outermost spherical surface. It must be assumed, however, that the same value of the angular momentum applies also to all other spherical surfaces with maximum amplitude.

As was shown at the derivation of (70), $l_A w(r_n)/n$ represents the rotation velocity of the spherical surface with radius r_n . With $l_A = n$, this velocity would be equal to $w(r_n)$, and it can easily be shown that the frequency on this plane would then be equal to f_e , i.e. to the frequency of a free electron, which is not permitted.

Therefore, the condition must be met: $l_A < n$ ($1 \leq n \leq n_A$).

From this follows that only $n_A - l_A$ surfaces of the n surfaces with $n^2 r_B$ can have a rotation velocity, which leads to the required angular momentum.

In other words: in the state A, which is characterized by the quantum numbers n_A, l_A , there are $n_A - l_A$ spherical surfaces, where the amplitude is maximal.

Between these spherical surfaces with maximum amplitude, there must be *node surfaces*. Thus, the number of the inner spherical node surfaces is $n_A - l_A - 1$.

Since we determined the number of the node surfaces that are planes through the state $A(n_A, l_A)$ as l_A , we come to the result that $A(n_A, l_A)$ is a spatial oscillation state with $n_A - 1$ node surfaces in total, of which $n_A - l_A - 1$ are spherical surfaces that lie inside.

This corresponds to the quantum mechanical definition of the *orbital*. However, at the orbital, rotation and oscillation are so to speak "frozen"; this is a consequence of the time-independence of the underlying Schrödinger equation.

(In order to determine the radii of the inner node surfaces as well as the distribution of the amplitudes in general, it would be necessary, besides the condition of the spherical harmonics also to take into account the r-dependence of the amplitudes. But this will not be carried out here.)

5.9. Atoms with Nuclear Charge Number $Z > 1$

Finally, here are some remarks about the generalization of the previous results to the case of a positive charge $Z\mu$ ($Z \in \mathbb{N}$, $Z > 1$), i.e. to atoms with a nuclear charge greater than 1. I will be brief, because the construction scheme remains essentially the same.

In all derivations, which were performed for $Z = 1$, μ must be replaced by $Z\mu$.

Thus instead of $w = \sqrt{\frac{\mu}{r}}$ must be set: $w = \sqrt{\frac{Z\mu}{r}}$

At the derivation of the radius of the n^{th} in-phase oscillating spherical surface, in the general case applies, exactly as in the case of hydrogen (see equation (65')):

$$r_n = n \lambda_{Ce} \frac{c}{w}$$

With $\frac{c}{w} = \sqrt{\frac{r_n}{Z\mu}}$ follows then

$$r_n = n^2 \frac{\lambda_{Ce}^2}{\mu} \frac{1}{Z} \quad (71)$$

$$r_n = n^2 \tilde{\lambda}_{Ce} \frac{1}{\alpha} \frac{1}{Z} = n^2 r_B \frac{1}{Z} \quad (72)$$

In the case of states with angular momentum $\neq 0$ applies, as before:

$$L_{md} = m r v_t$$

$$m = m_e, \quad r = r_n = n^2 r_B \frac{1}{Z}, \quad v_t = l w(r_n)/n = l \sqrt{\frac{Z\mu}{n^2 r_B \frac{1}{Z}}} \frac{1}{n} = l Z \sqrt{\frac{\mu}{r_B}} \frac{1}{n^2}$$

The factors Z cancel each other, and the result is again identical with (70)

$$L_{md} = l \tilde{\lambda}_{pl}^2$$

Note:

It deserves to be mentioned that in the metric dynamic model can easily be demonstrated that nuclear charge numbers $Z > 137$ are probably not possible.

We look again at the logarithmically scaled outline (S20):

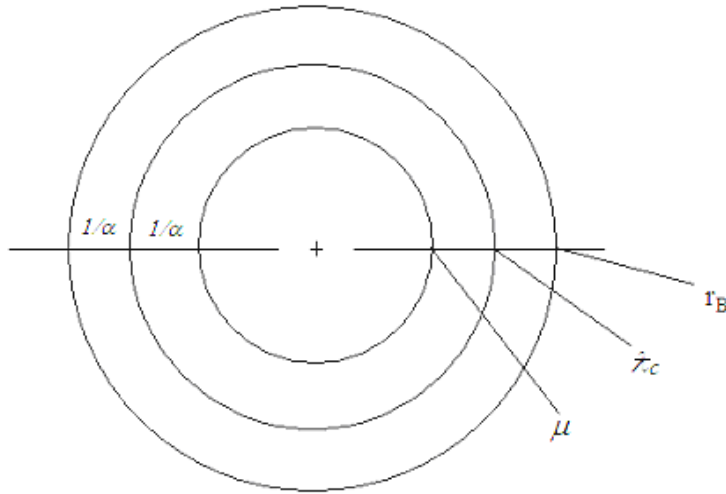

(S26)

Here, $\lambda_{Ce}/\mu = r_B/\lambda_{Ce} = 1/\alpha$

λ_{Ce} is the geometric mean of μ and r_B , i.e. of the geometric charge and the radius of the innermost shell.

However this applies evidently to any geometric charge $Z\mu$ and any according radius r_B/Z of the innermost shell: with increasing Z , the geometric charge approaches the Compton wave-length of the electron from the inside, and the radius of the inner shell approaches the Compton wave-length from the outside; the Compton wave-length, however, remains always the geometric mean of the two quantities.

$1/\alpha = 137.036$, and therefore, with $Z > 137$, the geometric charge $Z\mu$ becomes greater than λ_{Ce} . The innermost radius lies then within λ_{Ce} and therefore also within $Z\mu$.

However within $Z\mu$, i.e. for $r < Z\mu$, the velocity of the rotating metric flow

$$w = c \sqrt{\frac{Z\mu}{r}}$$

is greater than c , and, consequently, there is no longer a static real metric – exactly as is the case with gravity in the area $r < 2m$.

Though this is not a completely compelling reason that a limit of the possible nuclear charge numbers is reached, it can still be asserted that with $Z > 137$ something essential changes. It seems therefore unlikely that the regularities that apply to the cases with $Z \leq 137$ hold true in the realm outside of this limit.

Note: The Compton wave-length of the proton λ_{Cp} is smaller than the geometric charge μ by the factor 13.399.

From this follows that the positively charged nucleus lies *always* inside the area of the complex metric.

5.10. Interpretation: What is an Electron Shell?

What is the "electron shell" of an atom?

The metric-dynamic answer has been given already in the First Part. In the Second Part, it has been completed and specified. It reads as follows:

The electron shell of a nucleus with charge number Z is a stationary oscillation state of a spatial area, in the center O of which a positive geometric charge $Z\mu$ is located. This charge creates a field, which is defined by a rotating metric flow and a metric change of the circumferences of circles around O . The field represents the necessary condition for the stationary oscillation state "electron shell".

The shell is complete, if its negative geometric charge amounts to $-Z\mu$. Then the squares of the imaginary metric flow, which is connected with the negative charge of the shell, and of the real metric flow, which is connected with the positive charge of the nucleus, cancel each other out, and so do the metric alterations of the circumferences. The atom is then neutral

The interpretation of the electron shell as stationary oscillation state of a spatial area served in the First Part as basis for the explanation of the *reduction of the wave function* and for its description as an ordinary physical process. (See I, 3.6.)

This hypothesis, whose strength was at first that it enabled a consistent and objective interpretation of quantum mechanics, has now twice proven true:

On the one hand because it was possible to reconstruct an important part of the basic physical reality exclusively by the quantities metric density and metric flow – from which evidently follows that locally confined physical phenomena ("particles") are to be interpreted as stationary states of changes of these two quantities, and on the other hand because we succeeded in deriving many known atomic facts partly accurate, partly at least approximately under the assumption that electron shells are *in fact* wave states *and nothing else*.

This brings us to the next question: *What kind of waves are electron shells?*

Here, we constructed them as *phase-waves of the Planck-waves*, determined by the condition that they form standing waves. This condition appears two times: first it must be met in the longitudinal, radial metric flow, which is generated by the geometric mass m_e , and second in the transversal, rotating metric flow generated by the geometric charge $Z\mu$. Only due to the cooperation of both conditions the spatial wave structure can develop that presents itself as electron shell.

Are the material objects indeed phase-wave structures? This would mean that every physical process is *ultimately* a consequence of alterations of the Planck-waves. Is it possible that this is an artifact of a too much simplified description? I think no. The relations that followed from our approach are so specific and fundamental that it seems improbable that they could be explained also by completely different assumptions.

The next question is: *What is actually oscillating?*

This has already been answered. The amplitude of the waves represents the velocity of the longitudinal or the transversal metric flow or, alternatively, the metric density of the length or the angle.⁸²

The appearance of an "electron" is always connected with a local increase of the angle density. In the case of a "bound electron", the area of increased angle density is spherically symmetric, in the case of a "free electron", the greater angle density must be transported through space by the electron-wave. Presumably this means that the amplitude of the angle density does not oscillate about the value 1 but

⁸² According to our construction, the phase wave structure *electron shell* contains actually both kinds of waves: those which belong to gravity as well as those of electromagnetism. In the orbital, they are matched to one another. This suggests that in the oscillation states of the electron shells the information is hidden about the relationship between the strengths of the interactions.

about a value greater than 1 – as opposed to light waves, where no altered angle density must be transported and where the mean value of the amplitude is therefore 1.

The hypothesis that the electron shell is a stationary state of "normal" waves has some important consequences. They have already been mentioned in the First Part. However I will recapitulate them briefly and formulate them more precisely on the basis of the recently derived facts.

"Electrons", just as "photons", are transitions between different possible spatial oscillation states in the field of the charge $Z\mu$. The difference between both is that at the transition called "electron" the geometric charge changes, but not at the transition called "photon".

The transitions themselves – as always with standing waves – are indeed discontinuous, however only in the trivial sense, that the values of the quantities, by which the possible states are characterized, are not continuous but appear in discrete sequences. But the processes that cause the transitions are continuous – and this is exactly the same with electrons as with waves of any other kind.

In this regard, an electron can indeed be compared with an acoustic interval, which occurs at the transition between two states of a standing air wave in a tube and which therefore represents the difference between two tones.

Completely unsuitable, however, is the idea of an indefinable entity called "particle" that is "located" somewhere. (*What* should be located somewhere?)⁸³

Thus, from the metric dynamic viewpoint, it does not make sense to speak of the "number of electrons" in the shell, which is limited by the fact that no electron must match another electron in regard to all quantum numbers. There are not $2n^2$ electrons per shell but $2n^2$ possible oscillation states.

⁸³ Once again the acoustic analogy: electrons are in just the same sense "particles" or *not* particles as a standing wave in a tube consists of a number of particles or does not, or as the transition between one overtone to another overtone is a particle or not.

So if anyone wants to contend that an electron shell consists of a certain number of electron-particles, he/she can of course continue to use this designation – however consequently he/she should then also say that the oscillation state of the air in the tube that corresponds to the 5th overtone, consists of five particles, and that the transition from one overtone to another overtone is caused by a particle. And, above all, he/she should know that all these "particles" are by no means indivisible substantial entities but *gestalt phenomena*, which, under identical conditions, develop always anew in identical form.

With this, also the usual interpretation of the amplitude square of the wave function as "probability of the presence" of an electron becomes obsolete. However, this is by no means a loss: indeed, it is completely impossible to answer the question of *which physical entity* the probability actually refers to. The only possible answer would be: "To exactly *that* entity that is located there with this probability."

All that can be said beyond this nonsensical tautology is that the probability distributions of events, which are caused by the interaction with an electron, can be traced back to the distribution of the amplitude squares of the wave function of the electron.

However this connection is also substantiated by the pure wave interpretation, without going through the absurd detour over an entity "particle".

Let us assume e.g. that light is scattered on an electron-*particle*. Then the average scattering angle will be large where the amplitude square is large, because, in the usual interpretation, this means that the electron will be there with high probability.

But this is of course also true if the electron is interpreted as the whole *spatial oscillation state* and the amplitude is interpreted as angle density: where the periodic change of the square of the angle density is large, there also the average deviation of the light wave must be large.

And further: in the usual interpretation, the scattered photon causes, with a certain probability – that is again the square of a wave-amplitude – a transition, which can be measured.

In the wave-interpretation, the squares of the amplitudes add up, until somewhere a transition occurs. The result is in both interpretations identical.

I can only repeat what I have already stated in the First Part:

Understanding the electron as particle leads to irreparable conceptual difficulties. The absurdities connected with it result ultimately in the loss of *any* interpretation – which, at present, is only masked by the fact that the currently prevailing combination of total conceptual void and formal and experimental know-how is called *interpretation*, though it surely does not deserve this denomination.

This state of affairs appears all the more unpleasant, as clinging to the notion of "particle" in the form of a substantial indivisible entity is actually completely superfluous.

5.11. Closing

I close the chapter on electromagnetism and forgo a summary: everything important has already been said many times.

On the one hand, it seems inappropriate and arbitrary to stop at this point – there are too many unanswered questions.

Above all, the description of the *actual* electromagnetic interaction is missing. However the metric-dynamic prerequisites of the interaction have been established, and it would therefore be easy to define the acceleration of an object in the electromagnetic field as follows: proportional to the central charge $Z_1 \mu$, to the charge of the test-object $Z_2 \mu$, to $1/r^2$ and to $1/m$ of the object. ($\mu > 0$, $Z_1 \in \mathbb{Z}$, $Z_2 \in \mathbb{Z}$; m is the geometric mass. I have noted the according equation at the end of 6.2.)

But such a description would be purely formal and therefore unsatisfactory. In electromagnetism, by contrast to gravitation, there is no accelerated flow and thus also no direct acceleration. Everything needed must follow either from the frequencies, lengths and phases of the waves,⁸⁴ or – and this would be the more attractive variant – the electric and magnetic field can be derived directly from the rotating metric flow-field. In both cases, I have not succeeded.

On the other hand, it is completely justified to stop here. The main objective of this Second Part of my work is, to derive known hypotheses by using only the quantities metric density and metric flow and to prove in this way, that it is possible to start the project *philosophy of nature* not from the observable phenomena but from the other side – from the metaphysical preconditions of being, and for this purpose also in this chapter more than enough evidence has been achieved.

⁸⁴ If the interaction is to be described by waves, then there are two possibilities:

The first one is to describe it simply as *superposition* of the waves. The velocity that results from the superposition represents the outcome of the interaction. Two examples of such a description by wave superpositions were performed in the First Part in sections 3.4 and 3.5 on the Photoelectric and the Compton Effect.

The second possibility is to reduce the acceleration of an object in the field to the phase shifts of the waves in the field.

Notes

1. The considerations of this chapter confirmed the hypothesis which has been established in the First Part: quantum mechanics is the theory that describes stationary wave states and their transition probabilities.

These stationary states are to be understood as attractors of the local dynamics, which means: they are the simplest local oscillation states. Therefore, quantum mechanics is simple too. However for the same reason it is also not fundamental: the fundamental processes of development, transition and decay of such states are not contained in it but presupposed.

However for describing what happens in atomic orders of magnitude, quantum mechanics is well suited, and it might be possible that we will never succeed in formalizing the actual, causal wave-layer.

Here, the state of affairs is indeed comparable with that of standing air waves in wind instruments: the description of the frequencies of the harmonics is simple, and it is perfectly suited for describing what can be heard (observed). However the transition processes that occur between the different sound events are extremely complex, never identical and perhaps in principle but probably never in detail formalizable.

However in order to *understand*, what actually is going on while playing a trumpet and why it happens, it is required to look at the whole dynamics – and the same applies to the molecular and atomic events.

2. From the metric dynamic viewpoint, it can easily be explained why in the usual description the electromagnetic interaction (as well as all other interactions) is mediated by particles (bosons). The explanation works at first in the same way as the explanation of the (ostensibly) discontinuous transitions between the states of electron shells, which are interpreted as "photons".

Then, in addition to the assumption that photons are just these transitions themselves (and not particles), here the assumption is needed that a change of velocity is tantamount to a change of frequency – which, in the wave model, is a matter of course.

So if two objects interact with each other, then this interaction must result in a change of frequency. This change is – as always – continuous, but observable are – as always – only the discontinuous transitions to another oscillation state, which are then, according to the usual scheme, again interpreted as particles.

3. The difficulties of the unification of gravity and electromagnetism are to be seen as a consequence of the fact that the theory of gravity (GR) is *fundamental* and the theory of EM is *phenomenal*. As follows:

What is the reason that the frequencies of identical particles located at different distances from a mass are different? There are two reasons for that: the different propagation of time, and the energy difference.

Ontologically, however, an elementary fact can have only one single reason. From our point of view, it is the different time. From this follows the difference of the frequencies, and only through the *definition* of the energy as proportional to the frequency follows then the energy difference.

And now, what is the reason, why the frequencies of two electrons located at different distances from the nucleus are different from one another?

In the usual view, it must be the different energies, because EM acts within the flat spacetime, such that no change of time takes place. However if one takes this position, then one has accepted the fundamental ontological difference between EM and GR as a fact, and then the two interactions can not at all – or only by using absurd detours – be united.

In our approach, this difficulty disappears. In the metric dynamic model, also the different frequencies of the two electrons are caused by the different times. Here, both interactions are understood as alterations of spacetime.

Reality is woven by *one single law* – by the one described by equation (1). This law has two interpretations: in the first one, the longitudinal metric flow is related to the metric density of the length, in the second one, the transversal metric flow is related to the metric density of the angle; the first one leads to gravity, the second one leads to electromagnetism.

The phenomena that are currently grouped under the names "gravitation" and "electromagnetism" are, therefore, states and processes, into which reality organizes itself due to the fundamental law.

In this concept, gravity and electromagnetism are unified. They emerge from the same law. Both are dynamics of spacetime itself. At the same time, however, also their difference is cleared up: gravity is a phenomenon of the longitudinal flow and acts through the accelerated flow itself, electromagnetism is a phenomenon of the transversal or rotating flow and acts through waves.

Two Types of Mental Confusion

I. The Duck-Spaceship Dualism

What is that?



A duck.

But if a person sees this picture, whose mind is clouded by the fact that he thinks he knows, for reasons which he believes to be absolutely certain and irrefutable, that the image represents a spaceship? – Then he will not deny the evident form, he will claim that it is a spaceship in the form of a duck. If the object then waddles and quacks too, he has no problem. He simply asserts that the spaceship has all the features of a duck.

II. The Wave-Particle Dualism

What is that?

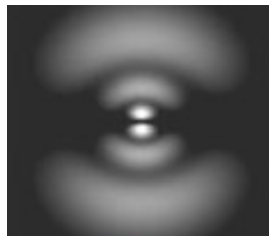

The distribution of the amplitude squares of the oscillation state of a sphere with three nodal surfaces: one of them in the form of a plane through the center and two in the form of spherical surfaces.

But if a person sees this picture, whose mind is clouded by the fact that he thinks he knows, for reasons which he believes to be absolutely certain and irrefutable, that the image represents a particle? – Then he will not deny the evident form. He will claim it is a particle whose probability is distributed just as the square of the amplitude of the oscillation state of a sphere. If the object then has frequency and wavelength and interferes too, he has no problem. He simply asserts that the particle has all the features of a wave.



6. A Universe without Mass

6.1. Preliminary Note

In the First Part has been demonstrated that essential interpretation problems like dualism and non-locality disappear, if the coexistence of particles and waves is replaced by a hierarchical structure, where the concept "wave" is *fundamental* and the concept "particle" is *derivative*.

A necessary condition for this change of interpretation is that the respective measurement results can be derived from wave attributes – particularly such results for which the concept *particle* at first seemed indispensable.

For the Photoelectric Effect and the Compton Effect, this has been proven directly: the experimental facts that result from the interaction between electron and photon have been derived from the wave attributes alone – without drawing on the particle concept or any particle attributes. This means that in the case of the Photoelectric and the Compton Effect the quantities *wave-length* and *frequency* are indeed fundamental and the quantities *momentum* and *energy* are derivative.

In the Second Part, the description of nature, using exclusively the quantities *metric density* and *metric flow*, was performed to such an extent, that it is now generally possible to define the quantities energy, mass, momentum, angular momentum, action etc. on the basis of metric-dynamic concepts and relations.

How can these definitions be carried out? To answer this question, let us briefly return to the First Part – to the section on the Photoelectric Effect.

Here, the equation for the velocity v of the emerging electrons

$$v_L = v_{e_0} \frac{v^2}{2c^2}$$

has been derived solely from the assumption that electron and photon are waves and that the interaction must therefore be understood as wave-superposition. The multiplication with h results in:

$$h\nu_L = h\nu_{e_0} \frac{v^2}{2c^2} = m_e c^2 \frac{v^2}{2c^2} = \frac{m_e v^2}{2}$$

Thus, the concept *energy* is unnecessary for determining the velocity v . Here, the only reason to define a quantity called energy by

$$E = h\nu$$

is, to enable the transition to the usual (post-mechanical) view.

So much to the considerations of the section about the Photoelectric Effect. They were, however, incomplete in two respects: *First* the identity

$$h\nu = mc^2$$

had to be *presupposed*. This incompleteness was eliminated in the Second Part by the metric-dynamic substantiation of equation (41') in Chapter 4

$$m c = \lambda_{pl}^2 \nu_m$$

The fundamental length λ_{pl} takes the place of the quantum of action.

Second, the definition $E = h\nu$ itself contains an undefined quantity, namely the *unity of mass*, since the quantum of action h has the dimension [kilogram meter² second⁻¹].

We will now turn to the elimination of this elementary incompleteness.

6.2. The Relation between metric-dynamic Physics and Standard-Physics

At first it appears as if we had arrived at an unsolvable problem, because the concept of *mass*, *measured in kilogram*, is not just undefined but, within the metric dynamic universe, seems indeed to be *indefinable*. In actual fact, however, there is a surprising and simple solution – so obvious that it could remain hidden to the eye that is wandering into abstract expanses:

In all physical definitions and equations, the mass M , measured in kilogram, must be replaced by the geometric mass m , measured in meter.

At first, this act may seem strange, but it is actually evident: gravitation and electromagnetism are geometricized – both are defined as *metric defects*. Mass corresponds to a *change of the length measure*, and charge corresponds to a *change of the angle measure*.

Therefore, the concept of a mass, which requires *a measurement unit independent of length and time*, is unnecessary. (Here, however, I will only refer to changes in the area of mechanics that follow from the elimination of mass.)

Under this condition, the entire formal system of physics remains the same in one respect: all equations are transformed into formally identical equations; but in another respect, it changes completely: in all equations, which contain the quantity mass, the dimension changes, because [kilogram] is replaced by [meter]. With this, *the set of basic measurement units is reduced*.

I will only briefly demonstrate how this works: (In the following, all metric-dynamic quantities are labeled by *.)

Let us start with Newton's equation force = mass times acceleration:

$$F = M a \quad \text{or, in differential notation:} \quad F = d(Mv)/dt$$

This turns into $F^* = M^* a$ or $F^* = d(M^*v)/dt$ (here, the geometric mass is denoted by M^* instead of m . Thus, M^* has the dimension length.)

Here are some examples of the changing of physical quantities:

	Dimension of the <i>mechanical</i> quantity:	Dimension of the <i>metric-dynamic</i> quantity:
<i>force:</i>	$\dim F = \text{kg m s}^{-2}$,	$\dim F^* = \text{m}^2 \text{s}^{-2}$
<i>energy:</i>	$\dim E = \text{kg m}^2 \text{s}^{-2}$	$\dim E^* = \text{m}^3 \text{s}^{-2}$
<i>action:</i>	$\dim W = \text{kg m}^2 \text{s}^{-1}$	$\dim W^* = \text{m}^3 \text{s}^{-1}$ etc.

We have
$$M^* = M \frac{G}{c^2}$$

From this follows that the relation between the metric-dynamic quantum of action h^* and the usual quantum of action h reads as follows:

$$h^* = h \frac{G}{c^2} \quad (\dim h^* = m^3 s^{-1}) \quad (73)$$

Then from $E = h \nu$

follows $E^* = h \frac{G}{c^2} \nu$

$$E^* = h^* \nu \quad (74)$$

To the elementary length λ_{pl} applies:

$$\lambda_{pl}^2 = \frac{hG}{c^3} = h \frac{G}{c^2} \frac{1}{c} = h^* \frac{1}{c} \quad (75)$$

Thus, the metric-dynamic quantum of action h^* is equal to the square of the elementary length times light-speed:

$$h^* = \lambda_{pl}^2 c \quad (75')$$

With this, some of the equations derived in the Second Part assume the known form. E.g. equation (70) for the metric-dynamic analogue of the quantum mechanical angular momentum

$$L_{md} = l \lambda_{pl}^2$$

turns into $L_{md} = L^* = l h^*$

(Here it must be taken into account that, in the derivation of (70), c is set to 1.)

Equation (41'): $M^* c = \lambda_{pl}^2 \nu$

turns into $M^* c = h^* \frac{1}{c} \nu$

Therefore $M^* c^2 = h^* \nu = E^*$

With this, also this important relation – which has been derived in a metric-dynamic way in chapter 4 – appears in its well-known form.

At last, a note about the gravitation constant G . It holds that

$$G = G^* \frac{G}{c^2}$$

Therefore $G^* = c^2$ (76)

This means: *the gravitation constant G loses its status as independent natural constant.*

The Newtonian approximation

$$F = G \frac{M_1 M_2}{r^2}$$

transforms into $F^* = c^2 \frac{m_1 m_2}{r^2}$ (77)

(Analogously, Coulomb's law

$$F_E = \frac{Q_1 Q_2}{4\pi\epsilon_0 r^2}$$

which describes the force between two charges Q_1 and Q_2 at a distance r , is transformed into

$$F_E^* = \beta c^2 \frac{Z_1 \mu Z_2 \mu}{r^2} \quad (\mu > 0, Z_1, Z_2 \in \mathbb{Z}, \beta \in \mathbb{R}, \beta \text{ is a constant }^{85})$$

With this simple formal act – the replacement of the mass M measured in kilogram by the mass M^* (or m) measured in meter –, the transition to a metric-dynamic description system is completed.

Now it is justified to assert that the concepts *metric density* and *metric flow* are fundamental and *all other physical concepts* are derivative.

In this way, the whole system of physics remains formally unchanged. All equations, all principles – as e.g. the principle of minimal action – remain true. (Indeed it would be completely absurd if this were not the case.)

Nonetheless, the understanding of nature has changed fundamentally.

(According to our definition of the electric elementary charge μ , the dimension of the electric charge Q changes in the following way:

$$\dim Q = \text{kg}^{1/2} \text{m}^{3/2} \text{s}^{-1} \quad \rightarrow \quad \dim Q^* = \dim \mu = \text{m}$$

Assigning dimension length to the electric charge is a consequence of the metric-dynamic view of the interaction, and the analogy to gravitation becomes apparent. The other electromagnetic quantities must be adjusted.)

6.3. On the Comprehensibility of physical Concepts and Relations

"It is important to realize that in physics today, we have no knowledge of what energy is."⁸⁶

Why is it that physical concepts cannot be understood beyond their mathematical definition? To answer this question, it is first necessary to distinguish between *basic concepts* and *derived concepts*.

⁸⁵ Presumably applies $\beta = m_e / \mu$ (m_e geometric mass of the electron). I didn't pursue this question any further.

⁸⁶ Feynman, Leighton, Sands, *"Lectures on Physics"* Vol. 1, 4–1, Addison-Wesley 1965.

In no description system – be it mathematical, physical or verbal – could be postulated that derivative concepts, which appear in statements that are the result of chains of conclusions, are immediately comprehensible. To understand such concepts, it is always necessary to track the logical path back to the basic concepts.

Therefore, it can only be demanded that the basic concepts are conceivable or evident.

The same applies to the relations between the concepts or variables of a description system. Again, there are elementary and derivative relations, and again only the understanding of the fundamental relations can be postulated – and of course the evidence of the inferences that lead to the derived relations.

So what are the basic concepts of a physical description system?

Within standard-physics, there are *length*, *time* and *mass*. What can be said about these concepts?

About length: There is no doubt that the notion length is evident.

About time: The notion time is not obvious. However, as already mentioned in the First Part, this problem can be solved by replacing *time* with *motion* as basic concept. Accordingly, *time* is then a derivative concept, which follows from *motion* and *length*. This replacement is possible, if there is a fundamental motion which any movement can be related to. Evidently, light meets this condition.

Formally, nothing changes due to the replacement of time by motion, however an epistemological uncertainty is eliminated.

Therefore, *length* is evident, and *time* can be understood by tracing it back to *motion* and *length*. If there were only these two basic concepts, then all basic concepts would be understandable.

With this, it is clear that it is the concept *mass*, which causes the incomprehensibility of physical concepts and relations.

In fact, a critical examination shows at once that the apparent clearness of this concept, though it is based on facts from the area of our everyday experience, vanishes into thin air if one tries to understand it as an *object attribute*. The question of what the mass of an object *actually* is, cannot be answered beyond measurement regularities.

There is a close connection with the problem of the notion *object*, if this notion is applied to anything which is thought to be elementary. It is then impossible to answer what this object *is* and *what it consists of*. However the notion *mass* relates to this questions, and therefore the inconsistency of the notion of an elementary substantial object is transferred to the (putatively irreducible) attribute *mass* of such an object (elementary means: not reducible to anything else).

By contrast, the geometric mass is free of such inconsistencies. It is not an attribute of an object that is assigned to this object just *by definition*, but – as metric defect – a constituting element of the object, i.e. an attribute that belongs to its metric-dynamic conditions and from which the effects emanating from it can be derived and understood.

Like the concept *object*, the concept *geometric mass* is derivative and not fundamental.

Now we proceed to the physical relations or laws. In the same way as with concepts, also here we must differentiate, as mentioned above, between fundamental and derivative laws. And again it can only be expected that the fundamental, which means: the elementary laws are immediately evident or comprehensible .

Standard-physics begins with Newton's equation:

$$\mathbf{F} = M \mathbf{a}$$

After what has been said, it is clear that already this first step leads out of the realm of the understandable: this equation contains the inaccessible and ontologically inconsistent fundamental concept *mass* and the derivative concept *force*, which in turn contains the dimension kilogram, such that the questionability of the concept *mass* is transferred to the concept *force*. The same applies of course to all other equations where a concept occurs which contains the dimension kilogram.

Metric-dynamic physics begins with the equation

$$\frac{d\sigma}{dr} = \pm \frac{1}{c^2} \frac{dv}{dt}$$

It contains the variables *metric density* σ and *flow velocity* v . Both are intuitively understandable. The relation between the two variables expressed by the equation follows directly from the analysis of the *origin of everything*.

This equation is the basis of metric-dynamic physics. It represents *the only one* fundamental metric-dynamic relation.

Therefore, as a summary, it can be stated:

Standard-physics contains the mechanical mass measured in kilogram. As fundamental, irreducible concept, it is inappropriate and, moreover, unnecessary. Its inaccessibility and ontological inconsistency is carried over to the whole system of standard-physics.

This concept of mass is connected with the concept of *material substance* and, with it, also with the idea of *elementary objects (particles)* which are always *substantially identical* with themselves; – an idea that – as has been shown in the First Part – leads ultimately to absurd concept formations like *non-locality* or *reduction of the wave function*. The consequence is a total loss of reality.

Metric-dynamic physics avoids these difficulties. The only basic concepts are *length* and *motion*. The only measurement units are meter and second.

Mass is a derivative concept. As such, as geometric mass, it is comprehensible, and the same applies to all other derivative concepts.

However, only if all concepts and relations are explained in a metric-dynamic way, we can speak of a fully comprehensible physical reality. We are still far away from this goal.

But at least we have covered a considerable part of the way.

7. Notes, Questions

Except for a brief note on cosmology, which will be the conclusion of the Second Part, now – as far as it concerns issues of physics – essentially everything is said what I have to say.

This chapter is therefore only an addition, a loose collection of notes, which seem to me worthy of mention for several reasons.

The four Interactions

Gravitation was determined as the field of laws that arise from the fact that, in the fundamental law, σ is interpreted as metric density of the length, electromagnetism as the field of laws that arise if σ is interpreted as metric density of the angle. However since there is nothing other than lengths and angles, the problem seems to appear that there is no room for other interactions. But this is not true for two reasons:

1. At the reconstruction of the atomic structure, not all possibilities have been exhausted. The condition of standing waves was only used for determining structures in the outer space. However this condition can also be applied *inwards*. The shell-model of the nucleus can be reconstructed analogously to the shell-model of the electrons, if the metric-dynamic procedure that was applied to the quantities geometric charge $Z\mu$ and Compton wave-length λ_{Ce} , simply is transferred to the quantities $Z\mu$ and Compton wave-length of the proton λ_{Cp} . This leads to a structure *within* the nucleus.

This fact as well as the close affinity of electromagnetism and weak interaction in the standard model suggest that the weak interaction can be derived from the flow rotation in a similar way as the electromagnetism.

2. Here, only the simplest linear regularities were taken into account. If, however, the waves of quantum theory are seen as actually existing waves – as is the case in the metric dynamic model –, then somewhere, which means: at a certain order of magnitude, the limit of linearity must be reached. It is reasonable to assume that this applies to the order of magnitude of the atomic nuclei. If this is true, then the strong interaction is presumably a non-linear phenomenon of the transversal (rotating) flow.

If there are also non-linear phenomena of the longitudinal flow remains open.

Regarding the strong interaction, also the following must be noted:

In the metric-dynamic model, the current description of the strong interaction cannot claim the same rank as the description of gravity. Rather it is an approximation, to be compared with the description of the planetary orbits by an epicycle system.

To substantiate this assertion, I remind you of the comments about the strong interaction at the end of the First Part:

On the one hand, quarks – the carriers of the color-charges – cannot be separated from one another, because the strong interaction does not diminish with the distance.

On the other hand, in a neutron interferometer, single neutrons are partitioned.

In the standard interpretation, this is "no problem", since the two rays which the neutron is split into are not seen as anything existing, but only as a mathematical tool: the wave-equations do not relate to real waves – their amplitude squares represent just probabilities of events.

From the point of view adopted here, however, denying the *existence* of a phenomenon which does not just correspond to a wave-equation but *actually interferes*, is not a possible interpretation but nonsense. From the fact of interference follows necessarily, that the neutron beams are not just mathematical tools but actually existing waves. Thus, the phenomenon called "neutron" is *actually* split.

But this fact contradicts the description of the strong interaction, according to which the neutron consists of three quarks which cannot be separated.

This means that the usual description of the strong interaction is an approximation, which – though it reflects the real circumstances quantitatively – does not correspond to that which *actually exists*; – similarly to the case of an epicycle system, which can represent the planetary orbits with arbitrary precision, though its parameters do not relate to existing quantities, or in the same way as Newton's description of gravity, which is a sufficient approximation for most cases, though its basic concepts completely miss reality.

What about the predictive power of the currently accepted description of the "strong interaction"? This is undoubtedly an argument that speaks for its current interpretation – albeit not a very meaningful one: probably almost every description, which contains general parameters by which some phenomena can be approximated, is capable of further approximately correct predictions.

From both Sides

If one starts the description of nature from *this side* – that is: the side of things –, then the initial concepts seem self-evident (particle, force etc.). This self-evidence, however, eventually turns out to be a deception, and the original content of the notions disappears. If then, ultimately, quantum objects are encountered, the failure of interpretation is inevitable. The initial ideas do no longer offer any possibility of understanding. Absurd concept formations are the result.

The objects of quantum mechanics cannot be interpreted as "real" in the usual sense. The consequence is that in the 20th century the interpretation of the real circumstances has been replaced by the interpretation of our failure to understand the real circumstances. The paradigms do no longer explain what happens, but instead demonstrate the impossibility of understanding what happens. The actual interpretation disappears or degenerates to the level of a mere manual for a *black box*.

This is problematic because science works only as interplay of interpretation and mathematics. In fundamental physics, the creative acts that contribute to the development originate in many cases in changes of interpretation. Only in the second step, when the creative act leads to a formal description, mathematics takes again the leadership. Fundamental Physics without interpretation is – as the experience of the recent decades teaches – incomplete and barren. Without interpretive guidance, the physical research takes wrong turns.

In contrast, if the description of nature starts from *the other side* – that is: from the side of the most abstract – then a totally different picture appears.

Following the principle of necessity, one is led to objects that exhibit exactly the differences to "normal" objects as prescribed by quantum theory. Yet it is these very objects – and only these objects – which we actually can understand, in the sense that they are derived from conditions, which are recognized as necessary conditions of existence, and that they are of metric-dynamic nature.

Exactly those elements of physical experience, which seemed to rule out a realistic interpretation for ever – imaginary dimensions, quantization, rotations at any direction etc. – prove to be necessary and geometrically understandable consequences of the build-up of physics upon the metaphysical conditions of existence.

It may contribute to clarity, to imagine the following classification:

There are two areas. The one is the area of physical objects. In the attempt, to substantiate the existence of these objects by concepts and methods which originate from this area itself, one arrives at its border – the "object-ness" of the objects dissolves.

The other is the area of abstract principles. Here, there are no objects. Objects must first be constructed – as patterns of the motion of AGENT.

In this image, quantum theory is to be regarded as interface between the two areas: at this interface, the objects derived from pure metaphysical necessity prove to be identical with those that represent the final step on the path of progressive abstraction of experiences in the world of things. Seen as such abstractions, they cannot be understood, however seen from the other side they are geometrically evident and necessary.

What are Material Objects?

Our investigations suggest the following hypothesis:

Material structures are interference phenomena, localized patterns of phase-waves of the Planck-waves, quantized through the condition that they form standing waves in the radial and in the tangential flow. The causal connections which these patterns are based upon and which determine their interactions do not lie in themselves but in the background of Planck-waves and flows.

The localized patterns can dissolve into the waves which they consist of. They will eventually emerge again at another position as identical patterns over identical background. However they are then not *identical* patterns in the sense which is suggested by the particle concept: the percentage of waves, which actually stem from the original, dissolved pattern can be negligibly small compared with the percentage that stems from other patterns of the same kind, which means: from *formally* identical patterns.

A basic Principle of Physical Reasoning

I use the thematic freedom of this chapter to sketch out a thought about physical reasoning, which, though I consider it important, as yet I did not mention, because its distance from the current style of thinking seems even greater than that of the hitherto presented thought trains.

I consider *conceptual and notional consistency* the fundamental principle of physical cognition. (Subsequently, I will illustrate what I mean by that.)

My confidence in this principle goes so far that I even think that this principle alone is sufficient to get to the true description of reality – and I think that the hitherto performed thought trains and results achieved through them justify this confidence to a certain extent.

If this is true, then follows that the proper strategy of physical reasoning is searching for such inconsistencies and eliminating them.

An example; Newton's theory of gravity contains a fundamental conceptual contradiction: a force exerted by a mass that acts through empty space upon another mass without any kind of mediation. This is evidently impossible. Thus, also the great success of Newton's theory cannot obscure the fact that it is only a *phenomenal* approximation, simply because of the conceptual contradiction contained in it.

With this, it is clearly specified what a "better" theory must accomplish: it must replace the action at a distance by a differential action that propagates "from point to point". This is exactly what Einstein's theory of gravity does, and in this way it eliminates the conceptual contradiction.

Now, however, appears yet another contradiction, which occurs also already in the Newtonian theory and which is not resolved by Einstein's theory. It manifests itself in the form of the unanswerability of the "why" question:

Mass curves spacetime. Why? This question is unanswerable. The connection between mass and spacetime exists only *by definition*, not other than the connection between mass and attracting force in Newton's concept. The *actual* problem, however, is not the unanswerability in the area of the description but the impossibility of the relation linked to it in the area of existence: spacetime is another kind of entity as mass, it is *essentially* different from mass, and has therefore nothing to do with it.

In general the following applies: only entities of the same kind can influence one another, and the mediating element must also be of the same kind. Thus, an alteration of spacetime can only be caused by spacetime and be mediated by spacetime. Therefore, the concept *mass* must be traced back to spacetime-alteration.

From this follows already, that everything that exists is of the same kind, or, to put it more exactly: that everything that exists originates from one and the same metaphysical primal ground, and further

follows, that all entities and their interactions are of metric-dynamic nature, because only if this is the case – that is: if everything is *spacetime alteration* – then the introduction of irreducible entities like *mass* or *charge* or *particle*, which are in no ontological relation with each other and are therefore *impossible*, can be dispensed with.

What is meant by that becomes clearer, if the notion "particle" is investigated, because it contains a contradiction that is closely related to the above contradiction:

In the case of a particle, there are two possibilities:

a) The particle is point-like. Then it does not exist and can therefore not be carrier of any attributes (charges).

b) The particle is spatially extended. Then the following applies: If it is elementary, then it is structureless. Then a spatial area "exists", which *by definition* falls out of time. Structurelessness means: nothing changes with time. Therefore, in the area without structure, there is no time. Time exists only outside of this area; it reaches up to its border, then it disappears, and only when we step out of the structureless area, time is again in effect.

This is obviously nonsensical in itself, and even more so due to the fact, that something, which is outside of time or without time, cannot influence something that is within time. (For this reason I've set the term "exists" in quotes: a structureless spatial area – which means: an elementary particle – can simply not exist.)

Therefore, there are no "structureless" elementary particles. Their existence is contradictory and thus impossible. Everything that exists must have inner structure and, therefore, be part of spacetime. The differential causal chains described by the fundamental law (1) cannot just end at a certain point; they must lead everywhere. In other words: everything that exists is a pattern of alterations of spacetime.

Thus, there is also a very short path to the fundamental knowledge about existence that is the basis of the physical description of the world presented here.

8. Cosmology

The metric-dynamic view of the universe leads to a cosmology that differs significantly from the standard cosmology. It will be outlined in this chapter.

What currently is told about the history of the universe and presented as secure knowledge is well known. So I can spare to go into it. Instead I want to ask you something:

Imagine, you measure the length of your dining table *today*. It is one meter. *Tomorrow* you measure again, and indeed with the same scale. This time the length is two meter.

What do you conclude? Either that the size of your dining table has doubled since yesterday, or that your scale has shrunk to half (– or that the size of both has changed, but we will ignore this variant).

Obviously, the two results alone do not permit any conclusion about which of these alternatives is correct. The decision is only possible if *further information* is available.

However exactly the same applies to the measured distance-dependent redshift:

Suppose we measure the wavelengths of two light rays that have been emitted from a certain element, say: Hydrogen, from two different cosmic distances – i.e. at two different points in time. The measurement is performed through a comparison with the wave-length by which the length unit is defined.

Evidently, there are two possibilities to interpret the distance-dependent redshift:

1. The universe expands.
2. The universe does *not* expand – instead our yardsticks shrink, which means: all wave-lengths, which may serve to define the unit of length, decrease with time. (Of course this applies also to the waves emitted by Hydrogen; however, from the instant of their emission, they remain unchanged.)

Also here applies that it cannot be deduced directly from the measurement whether 1 or 2 is true. For that, additional information is needed. The "rest of the circumstances" will motivate us to opt for one of the two variants.

This openness of the interpretation of the redshift is so obvious that the question arises whence the certainty comes with which has been assumed – indeed from the very beginning – that the universe expands, and why the alternative has never been seriously considered – all the more, as the assumption that the size of the universe is changeless and the redshift a consequence of the time-dependent decrease of the wavelengths that relate to material phenomena, would simply have made the absurd postulate of the so-called *big bang* superfluous.

It attracts attention that, in the historical development, there has never been any kind of doubt. The decision was clear from the outset, simply because the alternative did not lie within the horizon of the thinkable. This means that here deep unconscious prejudices are in effect – such ones, which exist prior to any act of thought and which represent therefore presuppositions of thinking.

It is also immediately clear *which* prejudice the view to the alternative option obscures: the notion of substantial, unchanging existence that persists in physics in the form of elementary particles and the associated natural constants.

In order to avoid nonsensical concept formations and to get to a consistent local and objective interpretation, it has already proven necessary – in the explanation of the theory of relativity as well as in that of quantum theory – to replace the idea – no: the *prejudice* of substantial existence by the idea of change (which, in the Second Part, has developed into pure, i.e. *subject-less* change).

Now, as regards the question of the history of the universe, the same applies. Again it is necessary to reject the idea, which originates from the depths of a priori prejudices, that there is something given as non-contingent unchanging existent.

Exactly this idea is the source of the presently prevailing conviction that there was *an absolute scale*, with which even the size of the universe in total could be measured, and from whose existence would have to be concluded that the universe expands.

The two alternative hypotheses shall now be discussed briefly. First, we formulate them more precisely:

Hypothesis 1: The wave-length, by which the length unit is defined, is *absolute*, which means: time-invariant. The distance-dependent redshift of cosmic objects is a consequence of the increasing size of the universe.

Hypothesis 2: *All* wave-lengths – those emitted by cosmic objects as well as those by which a length unit can be defined – are *variable with time*. The distance-dependent redshift follows from the fact that

all these wave-lengths decrease at the same rate over time. To put it simply: the size of the material structures decreases; the assumption of a variable size of the universe is superfluous.

The two hypotheses can be assessed in three ways:

1. Regarding the observations.
2. By the theories that play a role here.
3. On the basis of principal philosophical considerations.

Since by now you are somewhat familiar with my style of thinking, you know that I consider the third way the most important. Still, I begin with point one because it was of crucial importance in the historic development.

The observation which led to the assumption of an expanding universe was of course the distance-dependent redshift. But this observation does not only represent the beginning of this strange hypothesis but continues to be its fundament. However as such it is inappropriate, because – as was just demonstrated – it doesn't only support the assumption of an expanding universe but also the assumption of decreasing wave-lengths.

The second observation, which has led to the "conversion" of most physicists, was the cosmic background radiation, which had been predicted before and could be considered as echo of the "Big Bang".

How can the background radiation be explained within the frame of the alternative hypothesis?

Just in the same way as in the standard hypothesis. What is in general – apart from the question of variable or fixed size of the universe – the difference between the two hypotheses? As follows:

In the standard hypothesis, there are fixed ratios between certain quantities (natural constants), and, *additionally*, the quantities themselves are also fixed, that is: they have time-invariant, absolute values. In the alternative hypothesis, there are also fixed ratios between certain quantities (wave-lengths), but the additional postulate of fixed values of the quantities themselves is missing.

This is a strong argument in favor of the alternative hypothesis, because if there are two hypotheses that explain the same, the one with fewer presuppositions must be chosen.

Except that, in the alternative variant, everything which exists and which happens shrinks with time, physical processes are basically identical in both variants. From this follows that the observable phenomena do not permit to distinguish between the two variants.

An example: the so called cosmic time-dilatation. Suppose a far away event A causes another far away event B. In standard cosmology, the mediating process appears retarded, because event B occurs at a greater distance, such that the information about the event B reaches us later and, therefore, from our point of view the process seems to require a longer time.

In the alternative cosmology, the reason for the retardation is seen in the fact that the events are *actually* located at a greater distance from one another.

Does this mean that the alternative cosmology is just a spatial and temporal transformation of the standard cosmology? Not at all! Within the framework of the alternative hypothesis, the cosmos is a *closed metric structure*, and this is a fundamental change against standard cosmology. E.g. from this assumption follows directly a self-organization in the form of standing waves.

But we will get to that later. First, it should be noted that the alternative hypothesis based on the metric-dynamic physics is more than a mere transformation of cosmology, because it leads to a radical reinterpretation of the history of the cosmos, and because the "rest of the circumstances" – which, as elucidated previously, is indispensable for the decision which hypothesis to choose – is completely changed by it. The universe is then no more a building set, in which ever identical entities and their ever identical attributes form the reality, but a self-organizing structure, in which everything has *originated*.

Here, there is no room for the idea of *absolute existence*, which is the prerequisite for the assumption of an absolute scale. There are only waves which form patterns and whose lengths change with time. Only one thing remains constant: the ratio of the wave-lengths, because they relate to each other within the self-organization and are therefore bound to one another by natural laws.

However a stationary universe, as Einstein imagined originally, would be impossible for various reasons. One of these reasons is the fact that the equations of the general theory of relativity do not permit a time-invariant size of the universe. As is known, Einstein's attempt to make a steady universe possible by introducing the *cosmological constant*, does not work. The universe that corresponds to the adapted equations is not stable.

However the alternative hypothesis, according to which not the universe is expanding but all wave-lengths that relate to material phenomena change, does indeed not describe a stationary universe: the

dynamics which is necessary to avoid contradictions is simply transferred from the size of the universe to the size of the material structures.

Now I change over to the argumentation area that I consider decisive for the question, which of the two hypotheses must be chosen: the philosophical area. Here, the situation is perfectly clear. To say it in advance:

A variable size of the universe can be excluded on metaphysical grounds.

The basis of the argumentation is that the concept *size* is only applicable in the realm of the *existing*. It is a *relation* between existing objects or between quantities connected with these objects.

Right at the beginning of the Second Part, we have already encountered an entity which the concept of size cannot be applied to. The *origin of everything* – that, which neither is nor is not and which cannot be thought as it is *in itself* – has no size. Everything that is relational originates from it, but it itself is *not* relational.

Let us briefly return to the initial equation (1)

$$\frac{d\sigma}{dr} = \pm \frac{1}{c^2} \frac{dv}{dt}$$

The fact that the *origin of everything* has no size manifests itself in three ways:

1. There are only *differential quotients*, i.e. *alterations* of quantities. The quantities themselves do not appear.
2. The equation is *linear*. Linearity means size (scale) invariance. If an equation of the form $x = y$ is transformed by

$$x \Rightarrow qx \quad y \Rightarrow qy$$

then it remains identical.

3. A necessary condition for the simple form of equation (1) was to determine σ as *metric* density.

The metric density σ differs from the "normal" (one-dimensional) density ρ by the fact that there is no absolute value which the respective value of σ relates to; instead only *one* single differential time step is factored in. In other words: the normal density has a memory, the metric density has no memory.

However the absence of an absolute value means – at this level of reality and of its description – that there is no size. If σ were understood as normal density, then in equation (1) and (1a) the factor $1/\sigma$ would be necessary, and the size invariance mentioned at point 2 would disappear.

The difference between both kinds of density can be illustrated by the following thought experiment:

If one enlarges or reduces the size of a sphere, which is made of an elastic material and which, before the change, is in a (force-free) stable state, then a force will originate that acts against the change.

In the case of a *metric* sphere, however, in which only the metric density exists, enlargement and reduction are operations by which actually *nothing* is changed. The sphere is simply transformed into an identical sphere. *The idea of an absolute size loses its meaning and becomes empty.*

(But caution is required. From the scale invariance of (1) does *not* follow that a theory which is based on this equation is also scale invariant.)

Thus, at the beginning of the construction of physics from metaphysics stands the fact that there is no absolute size.

However the same applies to the universe *as a whole*. In the same way in which the *origin of everything* is not just a *thing with attributes*, also the universe as a whole is not a thing with attributes. *It is not relational.*

This fact reveals itself indeed immediately if the question is asked *against what* the universe actually expands. This question has already been posed many times, but hitherto nobody has drawn the correct consequence from the fact that an answer is impossible *on principle* – the consequence, that is, that it *cannot* expand, because here the concept "size" is not applicable.

The reason for this omission is that we *must* always think what we think as *substance and accident*.

At the beginning of our considerations, it was necessary to *objectify* the *origin of everything*. Though it does not divide into substance and accident, we had to assign to it *change* as attribute, in order to make it thinkable. And in the same way, as it was unavoidable to treat that which neither is nor is not *as if it*

were a *thing*, it is also completely unavoidable to objectify the universe as a whole. And *one* way of objectification – indeed the most common one – is to assign a size to it.

However isn't this justified simply for the reason that we can put any chosen length unity into relation to the size of the universe?

Not at all! From the metric-dynamic point of view, the possibility to speak and think of the size of the universe is nothing but an artifact of the *a priori* necessity to objectify (treat as a thing) everything which is thought.

So what should be done if the size of the universe appears as function of time in an equation?

Plain and simple: since it is not permitted to apply the concept "size", which belongs to the world of things, to the universe as a whole, the size of the universe must remain untouched. And from that follows that the time-dependent alteration must always be interpreted as a change of the scale.

Proposition:

There is no absolute size, only size relations.

Not the universe expands, but all wave-lengths that relate to material phenomena decrease – and this applies to the wave-lengths which we receive from the cosmos as well as to those which we use for defining lengths scales. (After the instant of the emission, they remain constant.)

This hypothesis is another important element of a universe that corresponds to the principles of reason. In this way, the assumption of the big bang becomes superfluous, by which the most important one of these principles is violated: the principle of the completeness of reality, which says that there is nothing but reality and that nothing – no model, no theory – can lead out of reality. Thus, if the big bang is understood as an event where *everything* originated – also, as is told, space and time – then, in light of this principle, that is simply nonsense.

In recent years, however, an increasing number of speculations has developed, that beyond the big bang might be another universe. Though these variants are to be preferred compared with the absurd idea of a beginning of everything, they still proof what had to be expected: just as in the context of the "reduction of the wave function", where now already for decades the strangest ideas have been roaming, also the Big Bang scenario turns more and more into a playground for the most absurd

fantasies, such as the idea of "spacetime bubbles" that arise constantly anew and evolve into universes. Here, science turns into science fiction and eventually into pure fantasy.

It is the fate of such erroneous assumptions to beget just more and more nonsense. So the respective scenarios are not at all *explanations*, i.e. they do not enable a reduction to something simpler, but on the contrary they represent *openings*, transitions to other, more complex scenarios with unknown elements, where always chance plays a central role. The apparent palatability of such fantastic amplifications merely obscures the fact that a real explanation is missing.

Dark Energy

The hypothesis that not the universe expands but the wave-lengths shorten permits not only to dispense with the absurd idea of a beginning of space and time, from it ensues also that the so-called *dark energy* vanishes into thin air. As follows:

In the standard cosmology before 1998, there were only two factors from which the velocity of the ostensibly expanding universe could depend: the *initial velocity* (after the end of the so-called inflation – a phase of exponentially accelerated drifting apart), and from then on only a gradual reduction of the velocity through the effect of gravity.

Thus, when at the end of the last millennium observations led to the conclusion that the speed of the expansion is increasing, this fact had no place in the existing model. Therefore it was necessary to introduce an *additional element* into the model – the so-called *dark energy*.

Such *ad hoc* introduced elements, which serve only for the purpose of eliminating a contradiction that occurs in an otherwise well-functioning model, are sometimes appropriate when problems of minor importance appear. However *dark energy* is by no means an unimportant element of the physical reality: it is supposed to account for 70% of the universe. So this is certainly the most enormous *ad hoc* conceptualization of all times!

That its invention, in accordance with the current presentation style in most branches of business, is celebrated by some physicists as the "dawn of a new physics", can hardly compensate for the fact that it is hitherto impossible either to integrate dark energy into the existing physics or to present just the slightest idea what a new kind of physics it should lead to.

How do the observational facts present themselves in the alternative cosmology?

The circumstances are straightforward:

Dark energy is the reason for the accelerated expansion of the universe. Thus, *if there is no expansion, then there is no dark energy.*

With this, everything of importance is already said. The unpleasant introduction of an unknown form of energy is superfluous.

Nevertheless, we will dwell a little on the subject, to discuss which observations are to be expected under the assumption that not the universe is expanding, but the wave-lengths are decreasing.

First it is to be noticed that a constant velocity of shortening of wave-lengths in the alternative model corresponds already to an increasing expansion velocity of the universe in the standard model.

A simple example for illustration:

Be t_0, t_1, t_2 three cosmic time points, $t_2 - t_1 = t_1 - t_0$.

At the time t_0 the wave-length that serves as length unit be equal to 1. If it decreases between t_0 and t_1 by 0.1 to 0.9, then in the standard cosmology this fact is interpreted as increase of the size of the universe by 1/9 of its size at t_0 .

An equally large decrease of the wave-length from 0.9 to 0.8 between t_1 and t_2 corresponds to an increase in size of the universe by 1/8 of its size at t_1 . Thus, the increase between t_1 and t_2 is $(1/8 * 10/9) = 1/7.2$ of the size at the time t_0 .

Therefore, the increase of the size between t_1 and t_2 is greater than that between t_0 and t_1 ; the speed of the expansion has increased.

This would be the case if the shortening of all material wave-lengths would have a constant velocity. However this is not a plausible assumption. More probable seems a periodic change of the wave lengths. (With a period of at least some ten billion years.)

To realize this, it might be useful to draw an outline of the self-organizing universe.

What comes to mind immediately if one thinks of a closed self-organizing metric structure? Of course standing waves. Comparable with a vessel driven by a strike into a vibration state that manifests itself as sound, the cosmos organizes itself, based on the laws (1) and (1a), in the form of standing waves.

(I've been asked at this point: Who strikes the universe? – Well, nobody. The *origin of everything* does not divide into substance and accident, it is not *something which* changes. That, which neither is nor is not, *is* change. Without change, it disappears. Thus, it need not be struck – no, it *cannot* be struck, because it is only there as "struck", i.e. as everywhere and permanently changing.)

Cosmic observations on the one hand and our considerations on the other hand lead to the following assumption:

The cosmos organizes itself in the form of standing waves in two orders of magnitude:

1. In waves of the magnitude of some hundred million light-years. Their oscillation areas are the cosmic voids, around which galaxies are arranged in the form of clusters and filaments. In this model, they represent the node "surfaces", i.e. the areas of lesser extent that lie between the honeycomb-like voids.

2. In waves, the wave-length of which is equal to the (here time-dependent) Planck-length. They are the basis of the material structures. Upon them, as outlined in chapters 4 and 5, the material world is built up in the form of phase-waves, whose wavelengths are in constant ratios to one another and to the Planck length.

If the basic law (1) were based on the normal density, then the universe would be comparable to an ideal elastic medium, and it would have to be assumed that it approaches a stationary state, an attractor, which is of a similar kind as the sound of a struck vessel. As mentioned above, such a state is not permitted.

Can the fact, that (1) does not contain the normal density but the metric density, prevent the existence of an attractor of this type?

I believe yes, and I think the reason is that, in the case of a law which contains the normal density, any attractor relates to the absolute value of the length, where the density is equal to 1 and no accelerations occur. In the case of the metric density, such an absolute value does not exist. Therefore, in the case of normal density, the accelerations depend on the *absolute value* of the length, whereas in the case of metric density, they depend only on the *temporal change of the length*.

Basically, there are two variants: either the material wave-lengths are shortened *ad infinitum*, or they change periodically. I prefer the assumption of a periodic change. A change that occurs permanently into the same direction would appear strange to me. I consider it probable that, in the context of the self-organization of a closed metric structure, most of the quantities are subject to periodical changes.

Back to the question: is the decrease of the material wave-lengths constant or variable with time? Here, the decision is easy:

Within the framework of standard cosmology, the assumption of an (approximately) constant velocity of the expansion follows simply from the fact that the velocity of moving masses is always constant if no force is acting upon them. This justification disappears in the alternative cosmology, because here the masses do not at all move away from each other. There is then absolutely no reason for the assumption, the change of the wavelengths would occur in such a way that it could be interpreted as constant expansion velocity.

Also the assumption of a constant decrease of wavelengths is improbable. The wavelengths would then eventually become zero – however not asymptotically but instantly. This is not plausible, and therefore it must be assumed that the decrease of the wavelengths varies over time.

However these considerations have no relevance for the question of *dark energy*. The only fact to note here is the following:

Observations, which in the standard cosmology must be understood as proof for the accelerated expansion of the universe and enforce *ad hoc* assumptions, are, in the metric-dynamic cosmology, compatible with the simplest model assumptions. In order to explain them, no additional assumptions are required – and this applies to *any* variant, regardless of whether it is assumed that the alteration of the wave-lengths has only one direction or that it changes periodically.

Actually, in the alternative cosmology the circumstances are exactly the reverse of the ones in the standard cosmology: In the standard cosmology, in order to explain the *change* of the velocity of the expansion, an *ad hoc* assumption is required, whereas, in the alternative cosmology, the assumption that the change of the wavelengths occurred exactly in such a way that – seen as expansion of the universe – it would correspond to a *constant* expansion velocity, would require an *ad hoc* explanation.

An alternative Story of the Cosmos

Let us in short complete our history of the self-organizing universe.

There is no beginning. The universe is a closed metric structure, which organizes itself in the form of standing waves in two orders of magnitude.

The first kind of waves is cosmic waves: longitudinal metric waves with a length of some hundred million light years. They form *cosmic voids*, which represent the oscillating areas of these cosmic waves. Where the voids adjoin one another, there are areas of lesser extent that represent the node areas of the cosmic waves. The pattern formation, which takes place here, corresponds to the formation of structures that is assumed in the standard cosmology. First, the simplest forms of matter develop. However – as elucidated in the previous chapters – their interpretation changes: the particles and fields that emerge are seen as *phase wave structures*.

Precondition of this kind of pattern formation is the existence of a second kind of standing waves, the lengths of which decreases in the course of the cosmic evolution. (Currently, they are by 57 orders of magnitude shorter than the standing waves of the first kind.) They are waves with Planck-length. They exist in the longitudinal flows, whose simplest forms were identified in chapter 2 with the phenomena called *gravitation* in standard physics.

The dynamics of the phase wave structures – in standard physics called "the four interactions" – leads to further pattern formation over many orders of magnitude, from atoms up to super clusters of galaxies. Since all structures within the node areas of the cosmic waves are based on the Planck-waves and remain connected with them, the size of these structures changes always at the same rate as the length of the Planck-waves.

Why do the wave-lengths change? Since, if the universe were an ideal elastic medium, a stationary state in the form of a basic frequency and harmonics would take place, the reason for the change must be sought in the difference between the universe of the alternative cosmology and a universe that organizes itself like an ideal elastic medium.

This difference consists, as mentioned above, in the fact that an ideally-elastic medium would have a normal density, while in the alternative universe everything depends on the metric density, in other words: exclusively on the temporal course of the metric length- and angle-densities. The absolute point of reference, which determines the behavior of a medium, is missing here.

Let us then assume the material wave-lengths decrease over time. What is the temporal development of this decrease? Presumably periodical, and the duration of one period should be substantially greater than the time which, in the standard cosmology, is currently considered the age of the universe since the big bang.

Perhaps after a certain number of periods dissolution of the material structure takes place, and then a new phase of self-organization begins.

However perhaps there is only one single period. The material structures originate, develop, shrink at the same time until a minimum is reached, then the material wave-lengths increase again – up to the point where all patterns dissolve again.

Then the game can begin anew.⁸⁷

Dark Matter

The outer areas of galaxies rotate faster than they are supposed to as regards the observed masses.

In the standard model, this means that there must be additional, not visible mass. It is called *dark matter*.

(The other possibility is to change the law of gravitation on large scales. Of course Newton's law – the $1/r^2$ dependence of gravitation – can easily be changed. However in fact the change is about *Einstein's* gravitation law, and this law provides much more resistance against the necessary correction. And this applies even more to the law of gravitation presented here: according to its nature it cannot be changed at all.)

Also here, the metric dynamic model of the cosmos offers the possibility to dispense with ad hoc assumptions.

⁸⁷ Since the directionality of time is a necessity only through self-organization and is thus bound to structure formation, the time has no direction in a phase of structural disintegration or absence of structures. This means that, if a cosmos disintegrates and another cosmos evolves, it is not possible to see the one as the "previous" and the other one as the "later" cosmos. So it cannot be claimed that the time can be extended without a limit "into the past" or "into the future".

Let us first ask: What is actually the difference between Einstein's view of gravitation and the metric-dynamic view?

Einstein describes gravitation as distortion of the space-time-continuum, whereas in the metric-dynamic model gravitation is seen as metric densification of space, i.e. as alteration of the length unit, from which in turn follows a *metric flow*. In this way, space turns into a dynamic entity, it becomes an accelerated flow itself.

In this view, at first time remains unaltered, and only at the transition to local observer systems, the valid local time can be derived from the velocity of the metric flow. As was demonstrated in the Second Part, in some simple cases (perihelion precession, light deviation, circular orbit of light), the results agree with those of General Relativity. However, if great masses are moving, the results of the two theories diverge, for the following reason:

The flow lines are accelerated by the masses. So they are *directed to* the masses, they *follow* them. This means: if – as in the case of galaxies – a great amount of mass rotates around a center, then *also space itself rotates*. The motion of the stars that results from their mutual gravitation plus the gravitation of the black hole in the center, must therefore be seen in relation to *that* space that is already rotating – contrary to Einstein's or Newton's theory, where of course it has to be understood as relative to *resting* space.

This means: *The rotation of space, that has to be expected in our view of gravitation, must be added to the rotation that follows from the usual view.*

Actually, Einstein's version of gravity and the metric-dynamic version agree exactly only in the case of gravity of one single object. However, in any real scenario, there is more than one object, and since the flow lines follow the movements of the objects which cause the flow, the motion of space must always be factored in. In many cases, however, as e.g. in solar systems, the adjustment would be minimal, because the main part of the metric densification and therefore also of the acceleration of the metric flow is caused by a central object. In the case of galaxies, however, this is not true. Here, the rotation of space contributes significantly to the observed rotation speed.

Admittedly, this explanation is just an outline.⁸⁸ But at least it shows very clearly the mechanism that lies behind the observed increased rotation speed. And, moreover, it demonstrates that the idea of a cosmos that organizes itself in the form of metric flows and waves offers much more dynamical

⁸⁸ More to that can be found in my paper [Against Dark Matter – A New Theory of Gravitation](#).

possibilities than the standard version – possibilities which provide more attractive explanations for the observed gravitational phenomena than the assumption of exotic kinds of matter.

In the standard model of cosmology, dark matter has a further important task: without it, no agglomeration of material objects could occur, which means: there would be no stars, galaxies, galaxy-clusters etc. Only dark matter allows the generation of these material structures. For this purpose, however, it is necessary to adjust *ad hoc* the amount of dark matter as well as the time of its decoupling from radiation in the early universe.

In the metric dynamic model, the initial structure-building is self-evident: space organizes itself into a shape of standing waves, which in turn form the large-scale background for the generation of material structures.

Comparison

Finally, we compare the two cosmological narratives:

What can be said with respect to the observational data?

As mentioned already at the beginning, the observations do not permit a decision which variant must be chosen. Since the structure formation, as far as material structures are involved, in the alternative cosmology is analogous to that in the standard cosmology, and since the hitherto applied physics is not suspended but only reinterpreted, the observational data confirm both models – except for two facts: some redshifts measured since 1998 and the dynamics of galaxies.

In the standard cosmology, these facts force two *ad hoc* assumptions: the existence of *dark energy* and of *dark matter*.

To say it very clearly: both facts *contradict* the hitherto prevailing concept of the cosmos and of its history. Therefore it seems entirely appropriate to interpret this as a refutation of the previous assumptions – as far as a refutation is possible at all. As is well known, any existing model can be immunized against emerging contradictions by *ad hoc* assumptions.

(Since its invention, however, dark matter proves to be very useful in computer simulations of the structure formation in the cosmos – to such an extent that now nothing works without it. But this is not, as some physicists believe, an argument for the existence of dark matter. It goes without saying

that an entity, whose distribution and properties can be determined completely free and unhindered by theoretical requirements, facilitates modeling.)

In the alternative cosmology, however, no additional assumptions are needed. The assumption of *dark energy* is superfluous, because here a non-linear redshift-law corresponds to the simplest model assumptions. (If it would actually be approximately linear in the long term, then exactly this fact would require an *ad hoc* explanation in the alternative model.)

In the alternative model, also the observed galaxy dynamics, which, in the usual interpretation, can only be explained by the assumption of additional non-luminous mass, does not require exotic *ad hoc* additions.

As regards the question of structure formation in general, the alternative model differs from the standard model in that it contains a top-down structure formation, which does not exist in the standard version: the large scale patterning in the form of standing waves. The structure formation in all orders of magnitude, which in the standard model still causes considerable difficulties, is thereby facilitated.

Summary

No beginning, no expansion, no absolute quantities, *self-organization* through metric flows and waves.

These are in short the main characteristics, by which the alternative model of the cosmos differs from the standard model.

No beginning: this corresponds to the principle of *completeness of reality*. The idea of a beginning of everything leads beyond reality and must therefore be rejected.

No expansion: this is a metaphysical certainty. The universe as a whole is not a *thing*. It is *not relational*. It would be nonsensical to assign a variable size to it.

No absolute quantities: this follows from the basic principles of this work, which have been introduced in the First and Second Part. In short: there are no absolute entities. Everything which exists is originated. Everything changes over time. In the context of self-organization, only the ratios of wave-lengths remain constant.

Self-organization by metric flows and waves: this follows from the build-up of physics from metaphysics.

These statements represent what, at the beginning of this chapter, was called *additional information*, which is necessary for the decision, which cosmological model must be chosen.

The hitherto acquired observational facts confirm both models in the same way – with two exceptions: gravity that cannot be traced back to the luminous matter known in current physics, and "accelerated expansion".

In the standard model, these two phenomena enforce the introduction of exotic entities.

In the alternative model, there is no expansion, such that the explanation of its acceleration is obsolete, and the just mentioned gravitational phenomena (e.g. the high rotation speed of the outer areas of galaxies) can be understood as part of the self-organization of the universe by metric flows and waves.

Note:

Seen historically, the question of whether the universe is expanding or the material wavelengths become smaller is of a similar kind as the question of whether the sun revolves around the earth or the earth around the sun. In both cases, the observable consequences of the competing hypotheses are (initially) identical, and the first-mentioned hypothesis is the one that fits perfectly into the just prevailing world view, whereas the alternative seems impossible in an almost ridiculous way.

Yet this belief is – in both cases – no more than a prejudice that occurs as a result of a series of other prejudices and vanishes together with those.

9. Propositions

P 1

The origin of everything itself is no being. It does not divide into substance and accident. It does neither exist nor not-exist.

P 2

*Thus the answer to the question: “Why is there anything and not nothing?” reads as follows: Since the origin of everything neither is nor is not, it is **necessary**, and with it that which originates from it – that is: everything which exists. (If nothing existed, then also the origin of everything would not exist – in contradiction to P 1.)*

P 3

Existence is activity. What does not change does not exist. The notion of something pure existing without changing is an artifact of the a-priori-necessity to think everything that exists as substance and accident – as combination of a thing that just is (inactivity) and an attribute (activity).

P 4

To make the origin of everything thinkable, change must be assigned to it as attribute.

P 5

If the change ended, nothing would be. Thus the chain of changes must be perpetual.

P 6

Therefore the fundamental law reads: one alteration is equal to another alteration.

P 7

The necessary conditions of existence are space and motion.

P 8

Therefore, the fundamental law must express the simplest relation between spatial change and change of motion. Spatial change is change of the metric density, change of motion is the acceleration of the metric flow.

P 9

Everything that exists is a pattern of changes of the metric flow.

P 10

As a consequence of the fundamental law, in the metric flow waves occur which propagate at the speed of light.

P 11

Gravitation is the dynamics of accelerated longitudinal metric flows caused by metric changes of lengths. In the case of central matter or antimatter, these changes lead to spherically symmetric stationary states of the longitudinal metric flow.

P 12

In the case of matter, the metric flow is real, in the case of antimatter, it is imaginary. The passing of time is retarded by matter, accelerated by antimatter.

P 13

Electromagnetism is the dynamics of the transversal metric flow caused by metric changes of angles. In the case of central positive or negative charge, these changes lead to spherically symmetric stationary states of the transversal metric flow.

P 14

At positive charge, the flow is real. Time passes slower. At negative charge, the flow is imaginary. Time passes faster. Positive and negative charge cancel each other out. Positive and negative charge

relate to each other with respect to the tangential flow in the same way as matter and anti-matter with respect to the longitudinal flow.

P 15

Longitudinal and transversal flows and waves follow from the fundamental law. Therefore, also gravitation and electromagnetism follow from this law. This is the metric-dynamic form of their unification.

P 16

Within the longitudinal flows there are standing waves of Planck-length. They represent the basis of the material structures.

P 17

Due to the radial flow caused by a geometric mass m exists, with respect to a system that rests relative to m , a phase wave of the Planck-waves. Therefore, on a spherical surface at the distance of one Compton-wave-length from the center, there is an in-phase oscillation with a frequency equal to the frequency of a particle with this mass.

P 18

Due to the tangential, rotating flow caused by a geometric charge $Z\mu$, the phase coincidence of this oscillating spherical surface is canceled. Thus tangential metric phase waves arise. The local metric oscillation states – i.e. the electron orbitals – are determined by the condition that the phase waves in the rotating flow system form standing waves.

P 19

Quantum Theory represents the interface between the abstract pre-stage of being and the world of things. The objects described by QT do not appear from either side as thing-like objects – as seen from the side of the world of things no longer, as seen from the abstract side not yet.

P 20

Material structures are interference phenomena, localized patterns of phase-waves of Planck-waves, quantized by the condition that they form standing waves within the radial and tangential flow. The causal relations which these patterns are based upon do not lie in themselves but in the background of Planck-waves and flows.

P 21

There is no "big bang" – the size of the universe does not change, because there is no absolute size, only size relations. Thus, that which changes is the wave-lengths by which our length unit can be defined.

P 22

The universe is a closed metric structure which organizes itself by metric flows and waves.

P 23

The pattern formation at the largest scale is the formation of standing waves of a magnitude of approximately 10^8 light years. They form the cosmic voids.

P 24

The formation of material structures takes place in the interstices of this honeycomb-like structure, i.e. in the nodal areas of the cosmic standing waves. It begins with standing waves of Planck-length, whose length diminishes with time. First, "particles" develop – metric densifications, which represent the necessary and sufficient condition for the formation of stationary phase wave states –, then "interactions" – flows and waves, which are caused by these metric densifications and which in turn determine the dynamics of the stationary phase-wave states. The material structure formation is analogue to that in standard cosmology. Due to gravitation, it reaches up to the order of magnitude of galaxy clusters.

P 25

Since there is no expansion, there is also no dark energy.

P 26

Gravitational flows are metric shifts. In their stationary form, they are identical with gravitation in the usual form. In their non-stationary form, they act like additional gravitation upon the dynamics of galaxies. The assumption of dark matter can be dispensed with.

Zeitgeist-Musical

A semi-dark factory shop. Machinery noise in the background.

Dramatis personae: PHYSICISTS, ENGINEERS, PHILOSOPHERS, the WORLD, the COSMOLOGICAL CONSTANT, the HOLY GHOSTS of physics, I MYSELF, an EXTRA-TERRESTRIAL GNOME.

Distributed over the entire stage are groups of PHYSICISTS and ENGINEERS, who are busy with work on strange machines. The PHILOSOPHERS form a separate group.

Downstage to the right several PHYSICISTS attempt to cram the WORLD into a bed bearing, in golden letters, the legend SO(10). The bed is too small. The WORLD puts up a desperate resistance.

The PHYSICISTS sing:

We love the groups! The groups are in, the world is out!

Then they proceed to cut off all extremities of the WORLD. It now fits into the bed. It is dead.

The PHYSICISTS sing:

We've done it! We've done it! We knew it could be done!

The PHILOSOPHERS sing:

The being of being is the nihilation of nihil.

Noise from the background. The COSMOLOGICAL CONSTANT refuses to appear on the stage. Some PHYSICISTS drag it onto the stage and do violence to it. It runs away and tries to escape. Once more a group of PHYSICISTS assaults it. Again it is raped.

The HOLY GHOSTS of physics move to the forestage and turn to the audience.

They sing in chorus:

In the name of the Holy Secret of Quantum Theory! Don't depart from the straight and narrow path of Uncertainty, of the reduction of the wave function and of the action at a distance!

But I say:

In the name of the Holy Enlightenment! Do you long for the secret or for clarity? Do you long for absurdity and unreality or would you rather have the solution to the puzzle?

The PHILOSOPHERS sing:

The nihilation of being is the beingness of nihil.

The COSMOLOGICAL CONSTANT is raped again.

Some ENGINEERS have taken the dead world from its bed and, after it, fashion a jointed doll.

They exult:

How much more beautiful it is than the ugly old one!

The HOLY GHOSTS sing in chorus:

In the name of Holy Mathematics! Don't permit yourselves to be dazzled by the brightness of understanding! Safety is to be found only in mathematical figures! Though the heavens fall and the world perishes, figures will be our salvation!

But I say:

In the name of Holy Reason! Do you want to be confused, figure-muttering observers of the unfathomable or cognizants of the real world?

The HOLY GHOSTS clamour:

Think about our successes! Where would you be without us? Without us you would still be squatting in some cave and picking off lice!

But I say:

Success is not tantamount to truth!

The HOLY GHOSTS by now are in a state of great excitement. They are all shouting at once:

Nonsense! We are going to win out! We are quite close to our goal!

But I say:

The curse of destruction rests upon you! In rational frenzy you are going to destroy everything!

A terrific uproar breaks forth. The HOLY GHOSTS chase ME across the stage. Some PHYSICISTS wave their instruments about in an agitated manner. Most of the ENGINEERS carry on with their work impassively.

The PHILOSOPHERS sing:

The negation of the negation is the pure negativity of the self-comprehending comprehension.

A gusty wind rises. It turns into a gale, then into a full-fledged hurricane. The entire scenery is swept from the stage.

Change of scene. A tranquil, but strangely unfamiliar landscape. I sit together with the EXTRATERRESTRIAL GNOME on the shore of a yellow gleaming lake.

The EXTRATERRESTRIAL GNOME asks:

Do you think there are extraterrestrial beings?

I say:

No, I don't believe so. Let's go for a swim.



Part Three

Mind and Matter

The Complete Concept of Reality

Natural Laws

Free Will, Qualia

The Visit of the Devil

Since I had strived for knowledge already quite a long time, I was not particularly surprised, when the devil visited me one day.

I asked:

What do you want?

He replied:

You know that. I will make you an offer.

I tried a cheerful tone saying

And what do you want in exchange? My soul?

He laughed:

No, for heavens sake, I do not offer reasonable people such old fashioned contracts! What I suggest to you, will cost you nothing. I'm going to give you exactly what you desire, and you are not obliged to anything.

This aroused my curiosity. I said:

Okay. Let me hear.

He then:

My offer is simple: I grant you a look into the innermost core of the world. You will recognize what is.

I was amazed:

What – and for that you want nothing in return?

He:

No. – No soul, no blood, no small print. You just have to agree.

I:

That's all?

He:

That's all.

He gave me 24 hours to think. I could not find anything that seemed suspicious. So on the following day I agreed.

He beamed:

Wonderful! And now –

he stood up and pointed his index finger in a dramatic gesture to me

– sorry, but without any magic, it's just too boring!

He waved his finger in the air. Red smoke enveloped us.

He exclaimed:

So be it as you wish!

Suddenly it seemed to me as if the world around me became transparent, and I looked straight through the things onto the glittering mechanism of the universe. It was so wonderful, so simple and beautiful that I could not avert my eyes.

I saw how infinitely fine threads of space and time were spun, stretching and then contracting again, coming closer to one another and then receding again, finally finding and embracing each other, forming shimmering, swirling shapes which themselves in turn – as soon as they emerged – began to dance together, first in simple figures but then in ever larger and more complex formations.

Before my very eyes, the fabric of reality unfolded.

I would have liked to remain forever in this blissful state of knowledge. However, eventually I became tired, the truth behind the things faded away, and my eyes were caught again in the visible reality.

But the world had changed. It seemed submerged in dark mist, and the light had turned pale. The foul odor of intellectual filth was in the air and took my breath away.

The world into which I had returned was a world of cruelty and stupidity, greed, dishonesty and vanity.

As he bestowed on me the gift of discernment, the devil bereaved me at the same time of the only grace that makes life among man bearable: the grace of imbecility.

And there's no way back.



1. Why do Laws of Nature exist?

1.1. Preliminary Note

Part Two has been devoted to the search for the laws of nature. The existence of such laws has been presupposed. Due to the success of natural sciences, this presupposition appears like a matter of course. Actually, however, here a fundamental philosophical problem is still waiting for its solution: the question, *why* nature behaves according to laws.

From where do these laws originate? Where do they exist? How is it that the General in the form of laws comes into nature?

As substantiation of the existence of natural laws, this chapter represents the completion of the physical part. Since the laws of nature, however, are creations or – if they are true – discoveries of our mind, it is at the same time the first step in carrying out the task of this Third Part: the elucidation of the relationship between mind and matter

1.2. The Problem

An apple is rolling toward the table edge.

What will happen when it rolls beyond? – *It will fall down.*

Why? – *All objects fall down.*

Why? – *They obey a law of gravity.*

All three claims appear undoubtedly correct. There is nothing of which we are more certain. Therefore, it seems all the more strange that our present knowledge about the relation between the Individual and the General does not provide any way to justify them completely!

Let's review the last two statements. The answer: "*All objects fall down*" is not appropriate to serve as substantiation for the certainty that the apple will fall down. All we know is that in all previous observations objects have fallen down. But the phrase "all previous observations," refers to a finite number of individual cases, and individual cases – no matter how many – cannot substantiate a universal statement of the form "all objects fall down".

In 1740 David Hume pointed out that the expectation, observed regularities would also be valid in the future, cannot be justified logically.⁸⁹ At first this is hardly surprising, because it seems obvious that in the area of observed regularities incidents happen. Such incidents may be remarkable, but we find nothing strange or even contradictory at their appearance. No one will feel any kind of metaphysical bewilderment when the bus, which always has left the station on time, still next time departs late.

Or to use one of Hume's examples: If we knew nothing about the sun, then the fear was justified, it could fail to appear. Only when we think we know *why* it appears, we feel safe. A God or a law could guarantee us that it will recur every day. Gods, however, are notoriously unreliable, and, in the past, too often they have been appeased not even by human sacrifice!

What about the more recent version, i.e. the confidence that stems from natural laws? Does the discovery of a natural law behind an observed regularity guarantee its future persistence? Does the law contain the answer, *why* there is a connection between cause and effect?

Within the framework of conventional physics, this is not the case. Any analysis of a causal connection inevitably ends up in a why-question that cannot be answered.

E.g. if we want to substantiate the fall of the apple through Newton's law of gravity, then it cannot be answered, why the earth attracts the apple.

In Einstein's law of gravity, there is no answer to the question, why mass bends spacetime.

Thus, in both cases, yet we arrive at an assertion that has been prompted by observations and confirmed by further observations.

Therefore the discovery of the law changes nothing: If we accept that our knowledge is based exclusively on individual cases, we must also accept that the feeling of secureness, which the law provides, is unfounded. The persistence of observed regularities is not more reliable due to the law: *First*, the content of the premises cannot be increased by logical reasoning, and *second*, cause and effect are not linked together in a logically justifiable manner, but merely by definition, and therefore

⁸⁹ In: *A Treatise of Human Nature*, I.IV.1. The question, whether empirical facts permit a conclusion to general statements is known in philosophy as "induction problem". This name, however, is simply inappropriate, because as regards the issue of induction, there is no problem: Induction is a suitable method for establishing hypotheses, but as a conclusion it is inadmissible, and that's all there is to say. However there is a *problem of justification of laws*, and this can only be called "induction problem", if it is presumed that our knowledge originates *exclusively* from experiences with individual cases.

the law cannot provide more safety than the mere regularity of the individual cases, which to date coincided with it.

If we cannot conclude from observed regularities to the future validity of these regularities – what is it then, which gives us the feeling of security? According to Hume, it is just a belief, based on usualness.

Does this mean that there is indeed a reasonable doubt of the existence of lawful causal relations? Should we actually doubt that the apple will fall down?

Though the mentioned arguments could be understood in this sense – such a doubt, given the tremendous success of natural science, would certainly not be appropriate.

Moreover, the skeptical doubt: "Why should the earth continue to attract objects?" is also relativized by the obvious fact that the earth perpetually attracts all objects, such that one could also ask the other way round: "Why should the earth *cease* to attract objects?"

However, what must be concluded from the skeptical arguments is that our understanding of the ontological status of the General is insufficient. The General seems to have no place in nature, which is given to us always in the form of observable individual cases, and this leads to the strange and irritating fact that we cannot doubt the existence of natural laws, but at the same time, we are not able to justify this certainty.

The skeptical argument, however, also has a serious defect, which becomes evident if one asks, why regularities can actually be observed.

Indeed, habits could not evolve at all if the things themselves would not induce them. If the bus would not *in fact* leave every day at the same time, then we would not expect the same for the following day. And the reason for its regularity is *its law*, i.e. the timetable, which it obeys.

And further: We could not develop the expectation that the sun will rise tomorrow, if it had not always done so. Or another well-known example: If the planet mercury would not always have moved around the sun (almost) exactly on an ellipse, then the respective expectation could not have developed, in other words: then Newton's theory of gravity would not exist.

From this follows that Hume's skeptical arguments are not sufficient for the analysis of the problem. Though it is true that we cannot conclude from individual cases to a law, in Hume's approach the

reason is missing, why nature exhibits regularities, with respect of which we develop habits and expectations.

Immanuel Kant thought he could remedy this deficiency by the assumption that causation lies not in the things – in the *thing itself* –, but in us – in the way things appear *for us*.

According to Kant, it is our mind that structures the observations as causal processes. This structuring is given *a priori* and therefore unavoidable. Thus, the reason for the universal validity of the principle of causality is, that everything which can be observed at all, is subjected to this categorical structuring.

In this way Kant avoids Hume's arguments, which of course relate only to the assumption of causality in the things themselves.

This, however, has absurd consequences on its own: The thing *in itself* is now completely under our control. It has no own, i.e. no regulations *in itself*, but merely satisfies *our* causal expectations.

One cannot help wondering what such a thing *in itself* actually does, if it does not affect the senses of an *a priori* structured being who commands it what to do. It must be lost in nothingness, because it is not only deprived of all regularities for its behavior – which is just categorical determinacy that stems from *us* – but also of space and time, which, as forms of perception, also belong to us and not to the thing *in itself*. Only when it again affects the senses of such a being, then it is released from its helplessness and knows eventually where and when it is and what it has to do.

Let us apply this strange assumption to a specific case – say: my car. The next morning, the thing *in itself*, which *for me* is my car, is still at the point where I parked it last night. Evidently, from this fact must be followed that gravity has been acting the whole night through – even in those moments when the car was not at all a car but just an unobserved thing *in itself*, which *as such* – if Kant were right – should not obey any natural law.

Or another example: the planet Mercury. We watch it for some time. It behaves in accordance with our *a priori* expectations (which, by the way, have changed since Kant: that time they were the expectations of Newton, currently the ones of Einstein, and lately there are also my own ones).

Then we interrupt our observations. Now the thing *in itself*, which *for us* is the planet Mercury, totters lawless in nothingness – but, if we look at it again, it appears nonetheless exactly at the position in space and time, where we expect it.

This idea is evidently nonsensical. The thing *in itself*, which *for us* is Mercury, must also have a determination *in itself*, by which it is guided if it is not observed. Moreover, the fact that it appears at the precalculated position proves that this determination must correspond either exactly or at least in excellent approximation to *our* law.

From this follows, that the observable regular behavior of things cannot sufficiently be explained by something, which is *in us* or stems *from us*. The observation of regularities presupposes in any case, that also the things *in itself* behave lawfully, which means that their regularity must lie in themselves and is not only imposed on them by us. And then, we arrive again at Hume's justification problem, and it remains again open, why the observed regularities should also apply in the future.

I close this introduction with an example. Everything said so far is summarized therein in a simple manner:

Suppose 10 experiments have been performed, which – except for position and time of the execution – have been identical in every respect. Thus, in all experiments, the initial conditions were identical, and also the results.⁹⁰ (Since it is impossible to prepare *exactly* identical initial conditions, this example is a thought-experiment.)

Now we consider a further experiment. We assume that also in this experiment the initial conditions are exactly the same as in all previous experiments.

The decisive question is: *What can be predicted about the result of the 11th experiment?*

The *natural scientist* will argue as follows:

"The parameters which are relevant for the experiment are identical in all cases. Thus it is always *the same* experiment, which already has been carried out 10 times. This assertion is proven by the identical results. Therefore, with certainty, the 11th experiment will lead to an identical result.

The *skeptic* will reply:

⁹⁰ Here, anyone who would like to take into account the conventional interpretation of quantum theory, needs to replace "same results" by "same probability distributions" and interpret each experiment as a series of experiments.

"You are speaking of the *general case* – so, as if there were a general experiment A, with which all individual experiments A_i could be identified. But this A exists only in your mind; in the reality only the individual cases exist, that is: the actually performed experiments. The General, to which you assign the individual cases, is not real but only spread out over reality by you yourself. Therefore, nothing certain can be said about the 11th experiment – unless you mean that the General that you invented commands nature."

The natural scientist:

"My General does not command nature, it corresponds with nature – at least in good approximation!"

The skeptic:

"Your General does not correspond with *nature*, but only with the hitherto observed cases. Nothing entitles you to believe that this General will continue to apply in the future."

The natural scientist:

"If there are only individual cases, which are not connected with each other, how can you explain why the experiments one to ten have identical results? – and that, by the way, regardless of your doubt, the next experiment will have the same result?"

At this point, we interrupt the debate; the issue at stake is sufficiently obvious:

*The experiential reality consists exclusively of individual cases. The General in the form of natural laws exists only in the description. So how can it be substantiated that the observed individual cases – not only the past but also the future ones – obey the laws that we establish?*⁹¹

⁹¹ It should be mentioned that modern science has weakened the skeptical arguments: If, in our example, the physicist contends that *the same experiment* has been carried out 10 times, only at different positions and time points, then he claims that the processes which occur in the experiments are invariant with respect to shifts in space and time and to rotations in space. Homogeneity of space and time and isotropy of space, however, are fundamental principles whose validity is unquestionable. Of course it can further be asked if they will apply also in the future, but such a distinction of a particular point in time – just the respective present – appears indeed more than absurd. But even if one believes that this argument is sufficient to eliminate the doubts about the validity of the laws of nature, there remains the uncertainty about the relationship between the Individual and the General and about the origin and the location of the General in the form of natural laws.

1.3. A Contradiction as Starting Point

The assumption that the laws of nature are just laws of our mind and that reality is directed by them – Kant's position – leads to nonsensical consequences and must therefore be rejected.

Hence the other assumption must be correct, i.e. the assumption that the regularities must be located in the reality itself.

However this assumption is opposed by the fact that reality *for us* consists exclusively of individual cases, which in turn would again entail that the General in the form of natural laws is only *in us*.

With this, we have once again arrived at a fundamental contradiction, which follows from a statement about reality as it appears *for us* – and I say "once again", because we have already met a contradiction of this kind: the contradiction which followed from the fact that being divides *for us* into substance and accident.

If a contradiction of this kind appears, it can only exist *for us* – reality *in itself* is free of contradiction. Thus, a difference has to be made: between what reality is *in itself* and what it is *for us*.

Here, the contradiction occurs, if it is assumed that there is no law in the reality itself and that reality consists only of individual cases, just as David Hume contended.

Therefore applies:

In the same way, as reality *in itself* does not divide into *substance and accident*, it does not divide into *Individual and General*, or, to say it more explicitly: it does not divide into that which *is* and the law which it obeys. Both are inextricably bound to one another.⁹²

The problem outlined in the introduction is therefore obsolete. The whole scenario must be analyzed anew and rebuilt.

We will now turn to this task.

⁹² The question of how *Universals* (general concepts) emerge and what kind of existence they have will be answered in 3.4. *Organized States in Neuronal Networks*.

1.4. The Origin of the Laws of Nature

The build-up of the scenario begins with the *origin of everything*. At the beginning of the Second Part, it has been determined as that which neither is nor is-not and which therefore is necessary.⁹³

In itself, it is the precondition of reality. *For us*, it is the precondition of the *description* of reality.

The *origin of everything in itself* does not divide into substance and accident and is therefore unthinkable. In order to make it thinkable, we must divide it into substance and accident. Then the substance can become the subject of a proposition, and the accident can become the predicate of this proposition. And if the proposition has the form of an equation, then the substance is represented by the carrier of the variables and the accident by their connection.

What can be used for the first proposition? Or let us ask more precisely: What is *permitted* for establishing this proposition, such that it can serve as justification of the General in the form of laws of nature?

The following three kinds of knowings:

1. Knowledge about reality in the form of a general statement, which does not represent a generalization of individual cases. (Would it have been achieved by induction, then it would be inappropriate for substantiating the general validity of laws.)
2. The necessary and sufficient conditions for the description of reality. (This is a matter of course: since every being stems from that what the *origin of everything* is *in itself*, that what it is *for us* must contain everything that is needed for the description of being.)
3. Logical and mathematical considerations. (Their general validity cannot be doubted. But of course it is possible to ask also for the origin of logic and mathematics. However this is not relevant here. It will be discussed in the 6th chapter.)

We start with an assertion that is unquestionably true:

⁹³ See Part 2, from 1.3. I will carry out the derivation of the first equation here once again, albeit in more detail and in a somewhat modified form, and, moreover, with special consideration of the justification of general statements about nature.

If exclusively knowings of the three just listed kinds are used for the derivation of the first proposition, then its general validity is granted. Under this condition, it contains only elements of general validity and, therefore, is itself generally valid.

Now to the derivation:

At the beginning stands the question of knowledge about reality. Is there any general assertion which we know about reality *directly*, not by generalization of individual cases?

The answer is *yes*. We know exactly that which was realized at the beginning of the Second Part:

Actually existing objects – in contrast to objects of a description system of reality – are *active*, which means they *change* something.

Is this secure knowledge? Yes, it is. Here is the necessity of thought which Hume demands and which any causal connection is lacking that is deduced *inductively*. Something, which does not change anything, does not exist.

Thus, the most general predicate must be *change*.

At the beginning of the Second Part, we have determined what the *origin of everything* is *for us*: *change of AGENT*. AGENT is, what everything comes from, what everything consists of and which everything owes its *activity*. AGENT is exactly that *nothing* which the subject of possible statements dissolves into, if one tries to determine the material carrier of the attributes of elementary objects – and which nonetheless cannot simply be identified with the purely notional nothing, because the purely notional nothing would not be able to change itself.

Thus, AGENT denotes that which disappears if one tries to think it, but of which is known, at the same time, that it cannot be nothing. AGENT is the most general subject.

Can anything be said about this AGENT? Can it be concretized? This is indeed possible, due to the following consideration:

The *origin of everything in itself* is the ontological presupposition of all being, and nothing else. Therefore that, what it is *for us*, must be the logical presupposition of the *description of being*, and nothing else.

What are the presuppositions of the description of being?

Except logic and mathematics – whose validity here is assumed as given⁹⁴ – there are only two: *space* and *time*.⁹⁵

Evidently, *space* is a necessary condition. *Some* kind of space is necessary to represent being and the change of being.

Time is also a necessary condition. Without time, nothing could change.

Space and time, however, (in connection with logic and mathematics) must also be *sufficient* conditions of the description of reality, simply because there are no other ones.

Therefore, space and time are necessary and sufficient conditions of the description of reality. This means: AGENT consists of space and time. AGENT *is* SPACE AND TIME.

Thus, SPACE AND TIME are the **first substance**. With this, they represent at the same time the subject of the most general proposition, whose predicate is the **first accident**: *change*.

So, to begin with, we have derived the following assertion: *For us*, the *origin of everything* is *change of space and time*. In other words: *For us*, reality is created through change of space and time.

Without the predicate *change* would be nothing. Thus from the change must follow something, and this consequence must again be a change of space and time. But only if reversely also the first change follows from the second one, then the unending chain of changes emerges that assures that there is not nothing. In this way, we arrive at an equation:

[(Change 1 \Rightarrow Change 2) *and* (Change 2 \Rightarrow Change 1)] \Rightarrow Change 1 = Change 2

Therefore, sought are two changes of space and time which must be equated.

What does it mean that space and time change?

⁹⁴ Evidently, also logic and mathematics do not exist somewhere "outside". There is but one reality. Therefore, also the conditions for the development of logic and mathematics must be contained in the primal scenario. This, however, can only be understood as part of an epistemological circle, which will be discussed in the 6th chapter. But since the validity of logic and mathematics cannot be doubted, for the moment they can be presupposed – just as if they came from "outside". This metaphysical inaccuracy will be corrected later.

⁹⁵ Here, alternatively can be set *space* and *motion*.

The only possible meaning is that spatial⁹⁶ and temporal *measuring units* change. This can be expressed by the variables spatial density σ and temporal density ζ , which are intuitively understandable.

Here, however, the following must be observed: Whatever follows from a change of these variables, must not depend on the *absolute* size (of length or of time): At this point, we are *substantiating* existence, which means: we are *before* existence, and therefore there is nothing which a length or duration could be referred to.

The condition, that the consequences of the changes of the variables must not depend on an absolute value, can be implemented mathematically if only *relative* changes of lengths are factored in. Thus, σ and ζ are not "normal" densities, which would relate to a fixed standard value.⁹⁷

I call σ and ζ *metric densities*. (On the definition of σ see Part 2, 1.4 and 2.3; ζ is defined analogously). They are dimensionless. σ is defined as length per length, ζ as time per time.

The statement, that nothing exists which can serve as given, fixed measure for lengths and times, is equivalent to the statement, that there is *no memory*, and this means, that only from that which has changed since the immediately preceding moment can follow anything at all – everything else is "forgotten".

The everyday language phrase "change from the previous moment" can be brought into an exact form by the mathematical concept of the *differential quotient*:

If a variable p changes "from moment to moment", then this is expressed in the form $\frac{dp}{dt} \neq 0$.

However due to dimensional reasons, which will be clarified in the following, here ct instead of t must be chosen as time coordinate, where c is a constant that has the dimension velocity.

⁹⁶ For simplicity, I confine myself here to length changes. Angle changes are completely analogous.

⁹⁷ It would be nonsensical to assign a "normal" density to space or time. Imagine the number line, which represents a one-dimensional space. If one pushes together the area between 0 and 100, such that it has only the range that previously had the area between 0 and 1, then cannot be asserted that now the density would be greater than before. Metaphysically spoken: here, it can be seen clearly that it is indeed not any existing object that changes but AGENT, which does neither exist nor not-exist.

Which parameters can change? In our scenario, there are only two: the spatial density σ and the temporal density ζ .

We start with a temporal change of ζ . This change will be the first term of the fundamental equation. First we write down:

$$\forall (r,t): \quad \frac{d\zeta}{d(ct)} \neq 0; \quad (\zeta = \zeta(t))$$

The temporal change of the metric density of time is nowhere equal to 0.

Why? This must apply, since the time-density itself does not exist at all – only its temporal change exists. Expressed metaphysically: without change would be nothing.

To get to our equation, we need a second term. Since the equation describes a change of space and time, and since the first term represents a change of time, the second term must represent a change of space.

Thus, the second term is either $\frac{d\sigma}{dr}$ or $\frac{d\sigma}{d(ct)}$.

If we chose $\frac{d\sigma}{d(ct)}$ as second term of the equation, nothing would follow from it.

Therefore we must choose $\frac{d\sigma}{dr}$, the change of length per length. Thus the *simplest* equation⁹⁸ which can be established reads:

$$\frac{d\sigma}{dr} = \pm \frac{d\zeta}{d(ct)} \tag{0}$$

Seen mathematically, this is just an equation. But seen ontologically, it represents what the formation process of reality is *for* us: ***the fundamental mechanism of the universe.***

⁹⁸ The postulate of utmost simplicity will be discussed subsequently. At first, we carry out the rest of the derivation.

With this, we have arrived at the point that is decisive for the understanding of the connection between Individual and General:

In equation (0), the relation between individual case and law is reversed. Equation (0) is not, as other natural laws, deduced from observed facts. It does not stem from experience, but from necessary metaphysical conditions and conclusions.

The equation describes *the generation of reality*. Therefore, it is not subordinated to reality, but precedes it.

Equation (0) is the law, which, by executing itself, turns into what is the case. The General turns into the Individual.

The general validity of this equation is contained in the conditions which it follows from. At first, however, it seems possible that it is only valid for a certain value of the two differential quotients. This can be excluded in the following way:

Let us denote the two differential quotients in (0) by x and y . We choose x and y as axes of a Cartesian coordinate system. In this system, $x = y$ is the 45° -straight line through the origin. Now we assume there was only one single value x_0 (and, accordingly, y_0) of the two differential quotients, for which equation (0) is fulfilled. Let (x_0, y_0) be the coordinates of a point $Q(x_0, y_0)$ on the straight.

Now we take into account that *there is no size* and that, therefore, (0) relates only to changes of *ratios* of lengths.

Mathematically, this means that in our (x, y) coordinate system the units can be chosen arbitrarily. Thus, also the position of the point Q on the straight is arbitrary.

And from this follows that there is no difference between the validity of the equation $x_0 = y_0$ *for a specific point* $Q(x_0, y_0)$ on the straight and the validity of the equation $x = y$ *for all* $Q(x, y)$, that is: *for the whole straight*.⁹⁹

⁹⁹ This train of thought can also be understood by not-at-all-mathematicians. Imagine a (very large) piece of paper on which the x - and y -axes are drawn perpendicular to each other, and, additionally, the 45° straight. Now, the statement *there is no size* is tantamount to *the distance from which the paper is observed does not matter*. This follows from the fact that from any distance *the same* is seen. Only if units are fixed and the corresponding points are drawn on the two axes, a distance-dependent difference can be observed.

From this follows: The combined statement

[*Equation (0) applies to points of the continuum with a specific value of the two differential quotients*] and [*there is no size*]

is equivalent to the statement

[*(0) applies to all points of the continuum*]

Therefore, the relation expressed by (0) is a specific fact and a general law at the same time. Here, the General and the Individual cannot be discriminated any more.

The just performed argumentation is only possible if the relation between the two differential quotients meets certain conditions. *Linearity* is the *simplest* possibility.

I've given this thought train a little more room, because in it the fact is reflected that, *in themselves*, the General and the Individual are not separated (as was stated in 1.3). Though this inseparability cannot be thought directly – just as the inseparability of substance and accident –, it is still possible to approach it by the above consideration.

It can also be recognized that the undividedness of Individual and General exists *for us* only as long as relation (0) is considered on its own – as a differential circumstance which is there *before existence*.

But if it executes itself, which means: if it generates the fabric of reality, then Individual and General separate in the following way:

That the metric densities σ and ζ have no memory, applies only to the differential relation itself. However, in order to describe a finite area of reality, $\sigma(r,t)$ and $\zeta(r,t)$ must be determined explicitly, which means: integration is needed. Then, though the initial value is still arbitrary, due to the fact that any differential change relates to the previous differential changes, a *memory* is created. Thus, all further mathematical consequences depend on the chosen initial value. The scale invariance of the differential law disappears.

These circumstances can be expressed in the following way:

The differential relation, which creates the fabric of reality, has no memory and no size. But in producing reality, it generates a memory and size relations. In this way, that which before has been the

Individual (an abstract fact) and, at the same time, the General (the fundamental law), turns into the Individual, i.e. to what is the case. But only *for us – in itself*, what is the case, the Individual, carries always the General.

One last step: If equation (0) should serve as basis of a physical description of reality, it must be transformed into a dynamic equation. This is achieved in the *simplest* way by interpreting the dimensionless quantity ζ as ratio of two velocities.

In (0), *one* velocity is already there – the constant c . Since only the necessary minimum of quantities is permitted in (0), c must also be used in the definition of ζ . Therefore we set:

$$\zeta = \frac{v}{c}$$

c is the constant, v is the variable. Then equation (0) turns into

$$\frac{d\sigma}{dr} = \pm \frac{d\frac{v}{c}}{d(ct)} \quad (0')$$

or

$$\frac{d\sigma}{dr} = \pm \frac{1}{c^2} \frac{dv}{dt} \quad (1)$$

So we finally arrived at the equation which was introduced in the Second Part.

(1) applies everywhere and anytime in the reality. (1) is the equation that describes the *generation* of reality.

Reality is a differential fabric of changes of space and time that are mutually dependent.

Everything that exists – any object, any interaction, any process – is a pattern of changes of the movement of AGENT.

Notes

1. At first three additions:

a) The basic concept "time" can be replaced by the basic concept "motion". Thus, instead of the concepts *space and time*, the concepts *space and motion* can be chosen as necessary and sufficient conditions of the description of reality. Then *their* changes – the differential quotients $d\sigma/dr$ and dv/dt – must be equated, and $1/c^2$ appears as proportionality constant. In this way, one arrives directly at (1):

$$\frac{d\sigma}{dr} = \pm \frac{1}{c^2} \frac{dv}{dt} \quad (1)$$

b) If one starts with a temporal change of ζ instead of a temporal change of σ , then follows

$$\frac{dv}{dr} = \pm \frac{d\sigma}{dt} \quad (1a)$$

(See Part 2, 1.5). From (1) and (1a) follows the wave equation

$$\frac{\partial^2 v}{\partial r^2} = \frac{1}{c^2} \frac{\partial^2 v}{\partial t^2} \quad (2)$$

c) Equation (1) has two interpretations: Instead as metric density of the length, σ can also be understood as metric density of the angle. (Part 2, 1.4).

2. At the transition from (0) to (0'), ζ was set equal to v/c .

From this follows that v/c is to be interpreted as *metric density of time*.

Here the relativistic fact appears that, with increasing speed, time is extended and space shortened. (Under the condition that, on the right side in (0) and (0'), the negative sign is chosen.)

3. On the question of *simplicity* of equation (1):

Apart from the fact that it is a dictate of reason to start with the simplest equation – and because Occam's knife anyway would cut off everything additional –, also a metaphysical argument can be introduced, why the first equation must have the simplest possible form. As follows:

In the *origin of everything*, there are two kinds of necessity:

First: it represents the necessary (and sufficient) condition for being.

Second: there is also a much more fundamental necessity in it, a *metaphysical* necessity, the one that follows from the fact that it neither is nor is-not. For everything that exists, there is the alternative that it does *not* exist. But for that which neither exists nor not-exists, there is no such alternative, and this means: it is necessary.

Now the question is whether this metaphysical necessity has a counterpart on the side of the description. I think that's the case, and I hope I succeed in demonstrating why I think so, without falling under suspicion of slipping into irrationality.

That the *origin of everything* is necessary means at the same time, that there is nothing superfluous in it. We cannot think what it "is", but whatever it is, must be free of anything superfluous. It "contains" only that, which makes it to what it is: the sole Non-contingent.

For this reason, that which the *origin of everything* is *for us*, should likewise contain only that, which makes it to what it is.

For us, the *origin of everything* is the origin of the description of everything: an equation, which contains a relation between two differential quotients.

What makes an equation to an equation? Or let us ask more concretely: What can be removed from equation (0) such that it does not cease to be an equation?

Since the differential quotients are determined by other conditions, the answer is *nothing*. Equation (0) has the simplest possible shape.

Conversely applies, of course, that anything which could be added to (0), is not necessary and therefore superfluous. Any further term, any additional variable, any exponent – which would represent an additional calculating operation – would be superfluous.

Thus, equation (0) contains exclusively what makes it an equation, which means: makes it what it is, and with this it represents the counterpart to the metaphysical necessity of the *origin of everything*.

4. Finally should be mentioned that (1) contradicts everything which is currently believed in physics – and also beyond physics – and which is considered to be secure knowledge about the foundations of being.

But that has already been discussed in the First Part.

1.5. Consequences

The just performed derivation leads to changes of the view of space, time and matter. Matter and space are brought under one concept, and, as an immediate consequence, time has a direction.

Since I've neglected as yet to explicitly point out these changes, now, at the end of the physical part, I'll make up for it with a few notes.

The Abolition of the Separation of Space and Matter

In standard physics, space and matter are separated from each other. Though by the concept of the quantum vacuum the border becomes permeable, the contrast between the two concepts remains. Even if "virtual particles" can originate in the vacuum, the concept of particle is still completely alien to the concept of space. Therefore, it is impossible to answer why matter in the form of material objects curves space (or spacetime). Nor is it clear why energy changes spacetime. Thus, also the concept "energy" cannot serve for an explanation.

From the viewpoint presented here, there is no substantial difference between space and matter (or energy). Equations (1) and (2) describe the generation of the *entire* reality, which means: of space *and* matter. In this sense, therefore, space and matter are *the same*; more precisely: they *are different states of the same*:

Material objects are (approximately) stationary states of metric flows and waves. *Space* is the area of metric flows and waves where such stationary states are either completely absent or occur only very briefly.

For us, the process of the generation of reality occurs *in space*. But *in itself*, space as such does not exist. There is no space, in which this process happens – the space where the representation takes place is only the background to which *we* must relate the changes, because we can think change only *within space*. But *in itself*, there is only change: the space, which does not change, does not exist, and the same applies to time.

The Impossibility of Reversing the Direction of Time

It is considered unsatisfactory by many physicists that, within standard physics, the direction of time can only be understood as a statistical phenomenon. The equations, which can be used for the description of physical processes, are time-symmetric. Therefore, *in principle*, also the processes themselves can be reversed in time, and the only reason, why such a reverse is never observed, is the – in most cases extremely low – probability of the initial conditions that would be required for a reversal.

Think for example of the well-known case of the glass that falls down to the ground and shatters. *In principle*, also the reverse process is possible: the pieces rise from the ground, join together, form the glass and land on the table. The required coordination of the random thermal motion of the floor molecules and of the glass molecules, however, is so extremely improbable, that it can be excluded that this ever happens.

The same applies to the pattern formation processes that occur in self-organizing systems, as described by chaos dynamics. In the mathematical description, the emerging patterns are represented by chaotic attractors in the phase-space.¹⁰⁰ Each attractor has a basin of attraction, within which any trajectory will approach the attractor. This means that here exists a direction of time.

But also here applies, that *in principle* also the reversed trajectory is possible (for $t \rightarrow -t$), and again the reason why this never happens is the extremely low probability that the system will move along this trajectory in the reverse direction.¹⁰¹

¹⁰⁰ The phase space (or state space, or parameter space) of a system is defined as a space, the coordinates of which correspond to the values of variables, by which the temporal development of the system can be described. (E.g. the positions and momentums of all particles which the system consists of.) Thus, a point in phase space represents the state of the whole system at a certain time point, and the movement of the point along a path (trajectory) represents the temporal development of the system.

¹⁰¹ A deeper analysis of this question, which leads to a different perspective, follows in [4.6](#) and [4.7](#).

In a universe whose fundamental law is equation (1), however, this issue changes in an essential manner:

In such a universe, *all* structures are patterns of the just described kind. Therefore, the time has everywhere a direction. Now, however, a system that organizes itself dynamically into patterns, does no longer consist of a finite number of particles, but is in any case a part of the continuum. From this follows that the probability, that any such self-organizing system – or also the universe in total – moves along a trajectory that lies within a basin of attraction *in the reverse direction*, is not just very small, but zero.

This, however, is not just a quantitative, but rather a fundamental qualitative – or say: ontological difference to the usual view. Now, the reversal of time is not only improbable – it is *impossible*.

In other words: the direction of time is a necessity.

1.6. Summary of the Relationship between Individual Case and Law

Reality presents itself to us as that which is the case. It seems as if reality consisted only of individual cases and as if nothing general could be found in it.

On the other hand, the General in the form of natural laws must exist, because otherwise the regular processes in nature that can be described by equations would not be possible.

Let us call this seemingly irresolvable contradiction *the paradox of the general*.

Also if being is investigated up to the elementary objects and the most general laws by which they are described, the contradiction remains. Still, being itself is individual, and the General exists only in the description.

Thus, in the area of the existing, no solution can be found.¹⁰²

¹⁰² Some physicists believe that the problem of the General in the reality is solved through the indistinguishability of elementary particles. In my interpretation of quantum mechanics, however, elementary particles are stationary wave states, which differ from each other exactly by those hidden parameters, which make the local and objective interpretation possible and permit the elimination of non-locality. (See First Part, Chapter 3.)

Therefore it is again necessary to go a step further – beyond that which exists to the *origin of everything*. Since everything which exists originates from it, it must be the origin of the Individual as well as of the General, which is present in the respective Individual.

For us, the *origin of everything* assumes the form of a proposition, which is of the utmost generality and therefore fundamental. It is not about being itself, but about the preconditions of being. It reads as follows:

The temporal change of the metric density of time is equal to the spatial change of the metric density of space.

This proposition meets the two conditions that are necessary and sufficient for substantiating the validity of general statements. *First* it is based on secure general knowledge – such knowledge which does not represent an abstraction of being, i.e. not a generalization of individual cases –, and *second* it describes the presupposition of *all* being: it is the description of the circumstance that generates reality.

For itself, this circumstance has no size and no memory. It can be seen either as a specific fact or as a general law. It is both at the same time.

By creating reality, it generates a memory and size relations, and, in this way, turns into that what is the case.

With respect to the description of reality, the fundamental proposition has exactly the status, which the *origin of everything* has with respect to reality itself: from the one emerges reality, from the other one follows the description of reality.

The general validity of the fundamental proposition is inherited by all statements that can be derived from it. If it is true, then this is the set of all deducible true statements about reality.

However we cannot know if the natural laws that we suppose to be valid are indeed true, as long as it is not known whether they are deducible from the first proposition. Can something be said about their general validity in spite of this uncertainty?

Yes. If a certain law A', which we assume, is at least an approximation of a correct law A, then, though we do not know if A' will apply in all cases, we still know that it differs from reality in some cases only because it is an approximation and *not* because its general validity must be doubted.

Thus, the general validity passes from the fundamental law not only to the laws derived from it but also to approximately valid laws. Also in the case of such laws, we are entitled to expect that they will apply also in the future to all cases, which are similar to those in which they have already proven to be appropriate.¹⁰³

With this, the substantiation problem of general statements is solved; the *paradox of the General* has dissolved. The conviction that laws apply generally, is justified.

This has been achieved through the elucidation of the origin of the General in the form of natural laws.

With this, at the same time the *direction* of reasoning has been reverted: now, instead of induction, derivation takes place. The (impossible) conclusion from Individual to General is replaced by the conclusion from General to Individual.

As regards the *induction problem*, it vanishes, because induction is no longer needed.

We experience reality in the form of phenomena that exhibit regularities. At first, we are not able to substantiate these regularities, indeed we cannot even consider them real – the General eludes us. But if we analyze the relationship between the Individual and the General on the basis of the preconditions of being, then we recognize that both, the phenomenon and its law, stem from the same last ground.

In any individual case there is also the General – it is made of it.

Addendum

I should explain a little more in detail *how* the general validity of the fundamental law is inherited by other laws.

I start with the question: *Why is induction not permitted?*

Let us call the assumption that identical circumstances have identical consequences *the principle of identity*.

Then the answer to the above question is: *Because the principle of identity cannot be presupposed.*

¹⁰³ From this follows that it is not necessary to assume that the fundamental proposition, which has been derived here, is true. For the justification of general statements, the assumption of the existence of a fundamental and true proposition is sufficient. This proposition need not be known.

This is the real core of the problem of induction, and exactly this deficiency is corrected by the fundamental law.

However it is a purely differential law. Thus, at first it ensures only that the principle of identity is true for *differential circumstances* – i.e. for differential spatial and temporal neighborhoods of points of the continuum.

Now we look at an arbitrary area of reality of finite extent at a certain point in time. Let us call such a temporal section an *extended circumstance*. Then the following applies:

Any extended circumstance can be seen as uncountably infinite set of differential circumstances, which are arranged in a definite way and to which the fundamental law applies.

Therefore, the principle of identity can be transferred to extended circumstances: identical extended circumstances must have identical consequences.

With this, the induction problem is solved. The general validity of laws and their validity in the future is proven.^{104 105}

However, due to this train of thought, another problem becomes visible: If reality is understood as fabric of differential circumstances, then the probability, that two areas of reality are completely identical, is evidently zero.

This means: The justification of the principle of identity represents at the same time the limitation of its applicability. This essential limitation and its far-reaching consequences will be discussed in chapters 4 and 6.

¹⁰⁴ As already mentioned, the question of how the General in the form of *Universals* comes into our thinking will be answered in Section 3.4. *Organized States in Neuronal Networks*.

¹⁰⁵ At last, a note to Karl Poppers proposal to replace induction by falsification. This is in fact *not* a solution of the induction problem, for the following reason: If the *principle of identity* is not already presupposed (that, in identical cases, nature will behave in the future exactly as it has behaved in the past), then from the fact that an individual case contradicts a law follows *nothing*. The law could actually have been true, but nature does no longer abide by it.

This means: only if the *existence* of true general statements about the reality is presupposed, then falsification is possible. However, since Popper does not proof their existence, he does not *solve* the induction problem – on the contrary he *presupposes* induction.

2. Mind and Matter: Preliminary Notes

2.1. Introduction: a fundamental Defect

Can we understand the world?

"Absolutely not!" replies the current physics and provides seemingly irrefutable evidence: e.g. the double-slit experiment, which ostensibly resists any thinkable description, or Bell's inequality, which is supposed to rule out any local interpretation of the world, or the relativistic spacetime conditions, which are considered as contradicting our *a priori* given ideas of space and time.

If the usual interpretations of these scenarios were indeed the only possible ones, then any attempt to find out what reality is and what it consists of would immediately fail, moreover it would even be downright foolish, because it would then be *proven* that our concepts are completely inappropriate for understanding reality.

Fortunately, it has turned out that this unpleasant view is wrong. In the First Part has been shown that not only the just mentioned but also many other paradigmatic physical scenarios can be interpreted conceptually in an insightful way, and that the single interpretations unite to an alternative picture of reality from which all absurdities have disappeared.

But even if now could be presupposed that we understand nature and that the known natural laws are true, the concept of nature achieved in this way would still be incomplete and profoundly unsatisfactory, because it would not contain the part of reality that we call *mind* or *spirit*, and moreover because – despite claims on the part of some philosophers and brain researchers – it is even *completely impossible* to unite mental and material reality in *one* picture within the currently prevailing scientific view of nature.

In the past, this incompatibility was of a purely philosophical kind. For Kant, it was possible to understand the contradiction between the certainty that we are part of nature and therefore completely determined by natural laws, and the conviction that we have a free will, as a consequence of the inconceivability of the *thing in itself*.

For us, this possibility no longer exists. Our knowledge about the relationship between neuronal processes and mental phenomena does not permit such a retreat into inconceivability. At the neuronal-mental interface – the brain – the grasp of the material nature and its lawfulness on the mental area is

so concrete, that it is no longer sufficient to reject the claim of natural science – or say: the explaining power of natural science – with general philosophical arguments. Rather we are confronted with the challenge of analyzing *where* the current scientific view of the mind is falling short, and to use this analysis as basis for the explanation of the relationship between mind and matter.

At the time when the natural sciences had only just received their Newtonian foundation, it seemed hardly possible that mind could result from interaction of material objects. Let us listen to what Gottfried Wilhelm Leibniz, who turned away from the atomic theory of his contemporary Newton because of this difficulty, had to say in his *Monadology* written in 1714: ¹⁰⁶

"17. On est obligé d'ailleurs de confesser, que la Perception et ce, qui en dépend, est inexplicable par des raisons mécaniques, c'est-à-dire par les figures et par les mouvements. Et feignant, qu'il y ait une machine, dont la structure fasse penser, sentir, avoir perception; on pourra la concevoir aggrandie en conservant les mêmes proportions, en sorte qu'on y puisse entrer comme dans un moulin. Et cela posé on ne trouvera en la visitant au dedans que des pièces qui poussent les unes les autres, et jamais de quoi expliquer une perception. Ainsi c'est dans la substance simple et non dans le composé, ou dans la machine, qu'il la faut chercher. Aussi n'y a-t-il que cela qu'on puisse trouver dans la substance simple, c'est-à-dire les perceptions et leurs changemens. C'est en cela seul aussi que peuvent consister toutes les Actions internes des substances simples."

(Moreover, it must be confessed that perception and that which depends upon it are inexplicable on mechanical grounds, that is to say, by means of figures and motions. And supposing there were a machine, so constructed as to think, feel, and have perception, it might be conceived as increased in size, while keeping the same proportions, so that one might go into it as into a mill. That being so, we should, on examining its interior, find only parts which work one upon another, and never anything by which to explain a perception. Thus it is in a simple substance, and not in a compound or in a machine, that perception must be sought for. Further, nothing but this (namely, perceptions and their changes) can be found in a simple substance. It is also in this alone that all the internal activities of simple substances can consist.)

Thus, in this section, which later became famous under the name "mill parable", Leibniz rules out that thoughts, feelings and perceptions could be created by "parts which work one upon another" (what today we would call "interacting particles"). But if these capabilities do not emerge from interaction of objects, then, he argues, they must be assigned to simple substances (which he calls Monades).

¹⁰⁶ English text: <http://oregonstate.edu/instruct/phl302/texts/leibniz/monadology.html>. (Translated by Robert Latta.)

How does the relationship mind – matter present itself today? Can Kant's antinomy between freedom and causality be solved by the knowledge about neuronal networks? Is Leibniz' mill parable still applicable? Are there any other substantial objections against the hypothesis that mind is generated by neuronal networks?

I take the following position: ¹⁰⁷

To the problem of free will:

The Kantian antimony is still valid. It cannot be solved without changing the paradigm of natural science that everything which happens is completely determined by laws – and it is irrelevant whether these laws are deterministic or "objectively" probabilistic. Under this condition, science and freedom are incompatible; from the thus seamlessly knotted universal net of causality, there is no escape.

Therefore, the assumption of freedom of mind is tantamount to a change or an extension of the currently prevailing scientific view of the world.

In chapters 3. *Free Will* and 4. *The altered View of Reality*, I will show wherein the illusion consists, which natural science hitherto has succumbed to; thereby, this illusion will be repealed. The possibility of free will is a consequence of this correction.

To the question of scientific describability of mental processes; the problem of the Qualia

Mental processes have an *information content* and a *feeling content*

The current scientific view of the connection between neuronal network and mind forces not only the surrender of freedom, it fails also in the explanation why mental states are *qualia*, i.e. why they have the quality of *sensation*, or the quality of *feeling* something.

The correction of the view of reality carried out in chapters 3 and 4 permits to understand mental features – perceptions, thoughts, consciousness – and also freedom of will. However also in this extended view, the *feeling content* of mental states is not included.

¹⁰⁷ At first, I will just outline my view in brief and only announce the solutions. Later, all aspects will be discussed extensively.

The problem of the qualia is even more fundamental than the one of free will, because here not only the validity of the *scientific* description of reality is at stake, rather it is about the question of whether and to what extent the possibility of a description of reality is given *at all*. The definition of the notion "red" cannot depict the mental state *red* – i.e. the sensation *red* –, and neither does a video or an equation of the neuronal activity which brings forth this sensation, and the same applies to any kind of description or illustration. The sensation *red* is not contained in *any* description. Thus, it represents an *irreducible* being, which cannot be *described* but only *experienced*.

As long as it is not cleared up, why the sensation *red* – or any other sensation – nonetheless can be understood as *natural* being, we do not know if mental phenomena do not contradict our concept of reality, and moreover, we can not even be sure whether we do not completely miss in our naturalistic model assumptions what reality *actually* is.

Conversely, the attempt to establish mind as basis of reality is devoid of any foundation. Everything we know about nature, we owe the natural sciences that are devoted to the investigation of material structures and processes. In contrast, the assumption that not matter but mind is the basic principle, has to date produced nothing other than speculation. Rather, all experiences clearly indicate that matter – or whatever one might call the kind of existence, which can be described by science – is a necessary condition for the occurrence of mental phenomena.

In chapter 5. *Qualia* will be cleared up, what can and can not be achieved by descriptions and why this is the case. The difference between material and mental entities will be analyzed. The results of this analysis permit to understand qualia as states of the evolving nature.

Are there other substantial objections against the hypothesis that mind is generated by neuronal networks?

No. Our knowledge about information processing and representation in neuronal networks has progressed so far that there is no longer room for fundamental doubts about this hypothesis.

(It must be cleared up, however, in what kind of relationship reality and representation stand. This will also be carried out in the 5th chapter.)

Therefore, if the attempt is successful, to substantiate – on the basis of the scientific worldview and by logical reasoning – freedom of will and the existence of the qualia, then all ostensibly insurmountable problems are eliminated, which so far have prevented the integration of mind and matter. Then both

phenomena can – without the use of exotic additional assumptions – be thought together in one concept of reality, without having to lose their essence due to this union.

For now, this brief outline of the problem of the relationship between mental states and neuronal processes is sufficient.

I leave the final word of this introduction to Erwin Schrödinger, who, like no other, has recognized the two main problems of knowledge based on modern science: the failure of the interpretation of physical – mainly quantum mechanical – circumstances and the failure of the attempts to integrate mind into the scientific worldview.

Schrödinger writes:¹⁰⁸

"Speaking without metaphor we have to declare that we are here faced with one of these typical antinomies caused by the fact that we have not yet succeeded in elaborating a fairly understandable outlook on the world without retiring our own mind, the producer of the world picture, from it, so that mind has no place in it. The attempt to press it into it, after all, necessarily produces some absurdities.

Earlier I have commented on the fact that for this same reason the physical world picture lacks all the sensual qualities that go to make up the Subject of Cognizance. The model is colourless and soundless and unpalpable. In the same way and for the same reason the world of science lacks, or is deprived of, everything that has a meaning only in relation to the consciously contemplating, perceiving and feeling subject. I mean in the first place the ethical and aesthetical values, any values of any kind, everything related to the meaning and scope of the whole display. All this is not only absent but it cannot, from the purely scientific point of view, be inserted organically. If one tries to put it in or on, as a child puts colour on his uncoloured painting copies, it will not fit. For anything that is made to enter this world model willy-nilly takes the form of scientific assertion of facts; and as such it becomes wrong."

So much for Schrödinger's view of the fundamental deficiency of science in the description of mental phenomena.

I agree with him. Now, however, Schrödinger means that, due to the fact that consciousness cannot be integrated into the current scientific worldview, it must be concluded that mind is not generated by

¹⁰⁸ Erwin Schrödinger: *What is Life?* and *Mind and Matter*; Cambridge University Press 1967. Chapter 4.

matter and that it exists in a way which cannot be realized by natural science: not, as we believe, as individual mind, but as a universal spirit, as it is seen in the Far Eastern tradition.¹⁰⁹

This is also the reason why I let Schrödinger have his say in so much detail: not because I share his view (which I certainly do not) but because he has left, due to the failure of the explanation of the mind from its material conditions that seemed inevitable to him, the field of rational thought and judgment – like many other great thinkers before and after him – and because his and their mental aberrations testify, what the consequences are of the enduring lack of insight into the relationship between mind and matter.

As long as this insight is missing, it will always be the very ones who most clearly recognize the problem, who are exposed to the temptation to seek salvation in untenable speculations, not other than it has happened in the epistemological area, which has been opened to irrationality by the failure of the interpretation of quantum mechanical circumstances, and where now rules jesters license.

Indeed applies quite generally that any incompleteness of the scientific explanation of the world represents an exit from the field of rational thought. The most popular exits, however, are in any case these two: quantum mechanics and spirit. More and more scientists, mystics, and followers of all religions, but also just "modern thinking" average citizens huddle there, to escape from the futile effort of reasoning into the blissful kingdom of nonsense and there to show off their tangled round dance.

Note

There is an important difference between the question: *Does free will exist?* and the question: *How can qualia be explained?*:

In the case of qualia, there is a real defect in our understanding of reality, which cannot be disposed of within the framework of the current scientific modeling. Thus, from the fact that qualia exist and that each quale is an irreducible being, follows necessarily that the current scientific view of reality is incorrect or incomplete.

This is different in the case of freedom of will. It is not necessary that free will exists. The assumption that it does not exist, does not lead to contradictions. Therefore, the fact that by the current natural

¹⁰⁹ In the same chapter.

science the existence of free will is ruled out, does not represent a *logical* proof for a defect of the presently prevailing scientific worldview.

However there remains massive discomfort: the elimination of free will would mean that we are no longer authors of our actions. Our free will would then be an illusion – in fact we would only act according to laws, by which, though we do not know them completely, we are determined, just like planets by the law of gravitation. With this, also the concept of responsibility would disappear. A being whose behavior – like the motion of a celestial body – is merely a consequence of the law by which it is determined, is not responsible for its actions.¹¹⁰

2.2. Overview on the next Steps

In what follows, I start from the premise that *mind* is a *natural phenomenon*, produced by neuronal networks of sufficient complexity. I will show that it is free, despite its inclusion in the causality of nature, and that qualia are obvious elements of a consequent view of reality.

Thus, the explanation has two stages:

1. The substantiation of the *freedom of mind*, without which – as just mentioned – we would not be authors of our actions.
2. The substantiation of the fact that mental states are always *qualia*, that is to say they have a subjective feeling content accessible only to the person (or being) who experiences it.

This schedule is imperative, because, on the one hand, the argumentation for the existence of the qualia is based on the one for the existence of freedom; on the other hand, however, both

¹¹⁰ Occasionally, brain researchers argue that concepts such as *responsibility* or *guilt* anyway should be retained because of their importance in the social context. Here, however, the strangeness of theories that consider mind to be determined by natural laws can be seen clearly: If *responsibility* and *guilt* are not mental but neuronal phenomena, then also *argument* and *will* must be neuronal phenomena. If the causal connections are located in the neuronal layer and not in the mental area, then a reason cannot be a reason and an act of will cannot be an act of will. Nobody has ever a choice – whatever happens always happens due to physical causes. Wanting something or arguing for something is therefore meaningless. Determinists who believe they argue are subject to a self-deception.

argumentation scenarios are independent from each other to such an extent that each of them must be considered on its own.

The objective of this two-stage thought train is nothing less than a new view of reality. Therefore I will not content myself with these meager notices, but at least give an overview with some remarks about the sequence of argumentative steps and outline the associated circumstances in a little more detail.

Free Will and the Completeness Axiom of Science

The current scientific view of nature can be characterized by the following assumption – let us call it A_{N_0} :

A_{N_0} : *Everything which happens follows from universally valid laws of nature and initial conditions.* ¹¹¹

However, what in a defined area of reality – in a "system" – happens is in many cases not only determined by universal laws of nature, but also by further laws, that apply only in certain systems. ¹¹²

This is easily demonstrated by the example of neuronal networks:

The description of the dynamics of a neuronal network refers first and foremost to the *structure* of the network and not to the details of the physical and chemical processes. Each brain researcher will conceive the neuronal network as a *cybernetic* system and not just as a physical-chemical one. Considering the network as a cybernetic system permits even to refrain entirely from the type of the physical realization.

This means, that here, in addition to the natural laws, another kind of laws determines the course of the neuronal dynamics, which might be called *laws of structure* or *laws of form*.

The same applies to the single neurons:

¹¹¹ With respect to quantum mechanics: *the probability of any event follows from ...*

¹¹² This is an issue of fundamental importance. In the following two chapters (3. *Free Will* and 4. *The altered View of Reality*), it will be discussed extensively.

Neurons are systems where a lawful relationship between input and output exists. This *neuronal input-output law* relates to the form and structure of the neuron. In this way, neurons *interact* with each other, not other than e.g. electrically charged particles stand in electromagnetic interaction with each other.

Thus, the neuronal input-output law can be regarded as *law of interaction of neurons*.

It is a law, which applies only to neurons and which occurs in addition to the natural laws. The mathematical formulation of the law is *independent of its physical realization*.

In order to take into account the existence of such specific laws that apply only in certain systems, the assumption A_{N_0} must be expanded to the assumption A_N :

A_N : Everything which happens follows from laws and initial conditions.

For the description of a system, the laws are brought into the form of specific equations. Equations are quantitative relations between variables. Initial conditions are the values of these variables at a specific point in time.

Therefore A_N means, that, for every area of reality, there is a system of equations that contains all information that is required for a complete description of this area. Thus, in this sense, any area of reality can be mapped onto such a system.

For this reason, I will call A_N the ***Completeness Axiom of Science***.

A_N contains two presuppositions:

The first presupposition concerns the laws. The expression "follows from" is only justified, if the equations that correspond to the laws provide an *algorithm*, that is: a procedure, which permits deriving and calculating future events from the present conditions through the application of defined rules.

The second presupposition concerns the initial conditions. If the equation system should contain in fact *all* information about reality, then it must be *infinitely precise*. But of course, initial conditions are never available "infinitely precise": neither is it possible to measure a system with infinite precision nor can any system completely be separated from its environment. (Thus, in any case, the whole universe would have to be taken into account.)

Moreover, already writing down numerically with infinite precision the value of one single variable would in most cases require infinite time.¹¹³

Therefore, A_N is not a statement about an actually existing equation system but about a purely mental construction.

Does A_N then represent a meaningful statement at all?

I think yes. A_N reflects the conviction that *nature itself is an algorithmic system*, which means: it produces the future from the conditions given at a specific point in time through the application of defined rules, and that this lawful process can *in principle* be reproduced by a description system – even if this reconstruction, due to the above mentioned restrictions, is only approximately realizable.

To consider A_N meaningful requires only two assumptions that actually appear obvious:

The first assumption is that the variables *have* exact values at any point in time,¹¹⁴ and the second assumption is that nature executes the algorithm by which the future is produced with these very values. Both assumptions are not challenged by the fact that *we* are neither able to write down these values within a finite time nor to execute the algorithm using them.

Let us return to our subject:

After what has just been said, from the scientific point of view it must be possible (in principle) to map neuronal networks onto a system of equations, such that the temporal evolution of the neuronal network corresponds to the temporal evolution of the system of equations, i.e. at any point in time the actual values of all variables would be equal to the (in principle) calculable values. Since this equation system is actually never available, in practice one must be content with approximations, e.g. by considering only the interactions of large ensembles of neurons or by directing the attention only to a limited number of neurons. The assumption A_N guarantees, however, that this approximations do not

¹¹³ One could also ask if it can be presupposed at all that nature itself obeys its law with infinite precision. This question, however, would only be justified if nature would indeed *obey* its law. According to the considerations of the first chapter, however, nature does not *obey* the law, but it *is* the law.

¹¹⁴ Quantum mechanically, this means (as ever), that there is a definite probability distribution of possible measurement values at any point in time. In my interpretation, which contains hidden parameters and is completely deterministic, this addition is of course superfluous. I just mention it to keep the argumentation on the freedom of will as far as possible independent of my own physical hypotheses.

necessarily lack anything "essential" – precisely because also the neuronal network is an "area of reality" that is *completely* determined by laws and can thus be mapped onto a system of equations; – and "completely" means that the equation system can reproduce *everything* which the network itself is capable of.

If all states of a network would actually be mappable in this way, then the according system of differential equations would also contain a description of the mental activity, which is produced by the network.

Under this condition, freedom of will would obviously be impossible.

Conversely, this means: From the assumption that we decide freely and according to our will follows necessarily, that the mathematical description of neuronal networks is *incomplete* – and it should be added, that it must be an incompleteness which goes beyond the above mentioned limitation due to the impossibility of infinite precision, that is to say an incompleteness which follows from the fact that *nature is not an algorithmic system*.

It is extremely important to recognize that the existence of free will does not depend on what *we* actually know or can know about a human neuronal network. Freedom of will does not only disappear if a lawful description is actually available, but already if the assumption is made that the *existence* of a complete mathematical description (of the kind defined just before) is possible, or, in other words, if it is assumed that the future is produced from the present in an algorithmic way.

Concretely: For the assumption of human free will, it is not sufficient that nobody knows exactly what a person will do, indeed it would not even be sufficient that this knowledge could never be achieved due to *technical* reasons; – for this assumption the much stronger condition must be met that such knowledge *is impossible due to logical reasons*.

Perhaps the following, slightly bizarre thought experiment may help to clarify the circumstances:

There is no doubt that the path of the planet Mercury is determined by the gravity of the bodies of the solar system. Let us now assume, Mercury possesses mind like us and is convinced that it has free will and chooses its path freely and with good reasons. Then this would be a self-deception of the planet, based on the fact that it does not know that its orbit is set by law.

We are certain that its path is determined, although the *exact* equation of the trajectory would never be available – indeed the positions and velocities of *all* bodies of the solar system would have to be

factored in – and though this equation, if it was yet available, would never be solvable.¹¹⁵ The reason why we are certain is that we simply *know* that the planetary orbits are determined *exclusively* by the gravitational field. This certainty is itself not scientific in a strict sense, but it is of course a presupposition of science and an unquestionable element of the scientific worldview.

If our own mental activity were determined by laws in the same way as the path of Mercury by the gravitational field, then obviously we would be in the same position as the planet who considers himself free. We would just believe to act willfully, but actually we would still always carry out what we are prescribed by law. Though we would not know the law of our actions, it would still always be present and lead us. And our mind would then be – though only *in principle* and never in reality – mappable onto an equation system, would be captured therein and have lost its freedom.

Under this condition nevertheless to assume that we acted according to our will, would be as absurd as the claim that not only gravity guides the path of the heavenly bodies, but also *a many-armed cosmic monkey*.

Thus we have arrived at the conclusion that at most one of the two assertions is true:

1. *Free will exists.*
2. *The Completeness Axiom of Science A_N is correct.*

This is the current state of affairs; an unpleasant alternative.

On the one hand, the assumption of free will is of essential importance for our self-understanding and the meaning of our existence. On the other hand, it is completely unclear how the possibility of mapping a real system onto a system of equations and initial conditions could be excluded.

In the chapters 3. *Free Will* and 4. *The altered View of Reality*, precisely this question will be in focus:

Why is the Completeness Axiom of Science invalid?

It will be shown that a representation of the dynamics of neuronal networks by a system of equations and initial conditions is not possible, and indeed, as required, not for merely technical, but for logical reasons.

¹¹⁵ "Solvable" means here and in the following, that a procedure exists by which future values of variables can be exactly calculated.

The proof is achieved through the derivation of the following proposition:

There are states of neuronal networks, whose formal representations are statements which are not derivable from any system of equations and initial conditions and which cannot be regarded as solution of such a system for any given time.

Thus, the Completeness Axiom of Science is wrong. Any formal description of nature by a system of equations and initial conditions is necessarily incomplete.

The scientific paradigm must be corrected.

The argumentation which is necessary for the proof of this assertion is sufficient for the substantiation of the autonomy of mind and the existence of free will. But this substantiation represents only a necessary and not a sufficient prerequisite for the understanding of mind, because still the explanation is missing what mental states *actually* are, that is: *qualia*.

The Problem of the Qualia

Nothing would be easier than to construct a robot which could associate the frequencies and frequency-mixtures of light that we perceive as red, with the word "red". It could be programmed in such a way that it says "red", if its optical chip gives it the information that such a frequency-mixture is present, while at the same time it directs its arm to the respective subject and moves towards it. For this performance, not even artificial intelligence would be required.

It would then be perfectly clear that the robot – I'll call it *John* to be able to come back to it later –, though it has the **information** which is necessary for the definition of "red", is still lacking the **sensation red**.

Red as quale – just that characteristic color sensation that *we* have when we perceive or imagine *red* – can never occur in the robot's simple program.

This example demonstrates clearly that a difference has to be made between *information* and *sensation*.

As a consequence, however, a series of questions arises, none of which has hitherto been answered – not even to some extent.

To name a few:

If a human experiences the sensation *red*, then the description of his/her neuronal activity contains the information without which the sensation could not exist. How is here the relationship between information and sensation? What is it which makes the sensation possible?

What is the difference between the state of a system, which contains only information, and a state, which brings forth a sensation?

Can artificial neuronal networks have sensations?

Obviously, the ability to feel anything is connected with the complexity of the neuronal networks that have evolved over the course of evolution. So the question arises:

On which rung of the evolutionary ladder turns information into sensation? Where becomes the automaton a sentient being? At the invertebrates? At reptiles? Fish? Birds? Or only at mammals?

By what does this change of the essence of being occur?

One can also ask more concretely:

Do bees perceive colors? Is their world really *colorful*? Or are they just machines that respond to light-frequencies?

Do crabs feel pain? Or are they just reacting to stimuli?

"Complexity" is often used as a magic word, as if it would be evident that, with sufficient complexity of a neuronal network, sensations would occur just "by themselves". This is of course nonsense. Complexity is just a necessary condition, but nothing else.

The same applies to the popular outside-inside discrimination. It is claimed, that information and sensation are *the same*: exactly that, which from the outside – by an observer – is seen as neuronal activity, is from the inside – by the "system" itself – experienced as sensation.

But also this assertion is no explanation, and moreover, it is even wrong, as will turn out later.

Thus, the central question remains: *What are qualia? In which way can qualia be understood as natural states?*

The formal-logical argumentation, which in chapter 3. *Free Will* served for the substantiation of the freedom of will, is not sufficient here, because the explanation of the qualia is based on the difference between *actually existing objects* and their *representations (descriptions)*, which can only be defined in a metaphysical manner.

Starting from this premise, one achieves, by means of some simple metaphysical conclusions, a broader understanding of being that contains both the scientifically representable reality and the reality of mental states.

Thus the three worlds – the material world, the world of the mental processes and the world of the discoveries and creations of mind – can be brought under one concept.

3. Free Will

Subject of the ensuing considerations is the *metaphysical* question of the possibility of free will.

Thus, we will not discuss psychological, sociological or other dependencies of volitional decisions, but solely the question of whether free will is possible *at all* – provided that we live in a universe in which, according to contemporary conviction, *everything* is determined by laws.

3.1. Preparation: Justification of psychological and mental Concepts

At present, the assumption is widespread that mind can be reduced to neuronal processes. Let us denote this position as "neuronal reductionism." It means the following:

Although we experience mental states as agents of mental activities, we are misled by this perception – *actually* mental activities are pure epiphenomena of neuronal processes, by which they are totally determined. One could also say: mental phenomena are *nothing but* neuronal phenomena.

Under this condition, it might seem at first as if the description of mental activity by psychological and mental concepts – like feelings, thoughts, reasons etc. – was an inaccurate form of representation, which should only be used until a more precise representation by concepts of the neuronal layer is available. Only then we would indeed know what e.g. the mental concept "reason" *actually* means – it might be a local energy minimum of the dynamics of a region of the neuronal network.¹¹⁶

Let us investigate to what extent this idea of a possible elimination of mental notions and concepts is justified.

A necessary premise of neuronal reductionism is the assumption of the autonomy of the neuronal layer that represents the basis of the reductionistic argumentation. This means that one can speak of *neurons* and *neuronal processes* and need not resort to molecules, atoms or elementary particles and their interactions.

¹¹⁶ The term "dynamics" refers to the temporal evolution of the state of a system. "State" means the set of the values of all variables of the system (quantum-mechanical: values of all simultaneously measurable observables) at any given time.

Can this autonomy indeed be presupposed? In some respect this seems so self-evident that one could consider it as a fact that does not require special attention: indeed one can *see* that neurons exist, that they interact, that the motion of molecules is determined by the *form* of the neurons – and therefore a description of the neuronal activity based on the terminology and the models of neurophysiology and neuro informatics seems adequate.

From the reductionist point of view, however, using structures as basic elements of the description which by themselves are already aggregates of simpler components can not at all be considered a matter of course. In any case the reductionist must reason why the elements of his/her description (neurons) can themselves be complex and why he/she does not need to use *really* elementary constituents.

As main reason – and we can assume that a reductionist would argue in the same way – for the adequacy of a description on the basis of neurons the following can be asserted:

Neurons interact *as neurons* with each other, that is to say: neuron assemblies can be understood as cybernetic systems that are completely determined by the relations between their elements, such that for a description of the structure and dynamics of states of neuronal systems it is irrelevant that they are *actually* (from the reductionist point of view) molecules (or atoms, or elementary particles). The kind of physical realization is negligible (– which is also a necessary premise for computer simulations of neuronal processes).

We now focus our attention on a higher level of complexity: we consider the layer of *mental states and processes*. We define “mental states” – in accordance with the usual definition given by brain researchers – as *global patterns in space and time* of the neuronal network, where many areas of this modular constructed network are simultaneously activated which represent different aspects of facts and circumstances of a situation and are connected with each other as long as the state persists.

Without going into too much detail, some areas can be mentioned: modules which belong to perception and represent the (actual or visualized) scenic aspects, various modules in the front region of the brain which serve for the analysis of complex interrelations (e.g. for the evaluation of the social consequences of an action), motor modules, the speech center etc. – however in any case also parts of the diencephalon, which connect the neuronal system with chemical regulatory systems that modulate the behaviour and are indispensable for the intentionality of mental states.

Now follows the essential step for the justification of psychological and mental concepts:

Everything that can serve as argument for the adequacy of a description of the activity within the brain based on neurons and neuronal processes and not on molecules (or atoms, or elementary particles), can serve as well – identically or analogously – as argument for the adequacy of a description of mental states and processes by mental or psychological concepts and models – like e.g. "perception" or "thought" – and not by neuronal ones.

Just as neurons interact *as neurons* with each other, also mental states interact *as mental states* with each other; In the same way in which can be asserted: the output of the neuronal module A causes the state of the neuronal module B, it can also be asserted: the mental State B is the consequence of the mental State A – precisely as it happens e.g. in the case of thought trains.

Thus mental states are interconnected *with each other*, they cause each other, they determine their chronological succession – in short: *they form a layer of reality, which is just as self-dependent as the neuronal layer*.

Just as the description of the neuronal dynamics permits to abandon the material condition of the cybernetic elements (the single neurons) – that is: that they are aggregates of molecules –, also the description of the dynamics of mental states permits to abandon the material condition of the cybernetic elements (the single mental states), that is: that they are global neuronal patterns.

In short: *Mental processes have the same right to a specific independent description as neuronal processes*.

Therefore, statements about mental circumstances – like the argument, which is usually held up by philosophers against reductionists, that in the mental area *reasons* apply and not *causes* – are justified in exactly the same way as statements about neuronal circumstances – like the assertion that an idea becomes a memory due to the fact that the connections between simultaneously active neurons are strengthened.

Thus we have arrived at the following conclusion:

If the neuronal layer of reality can be described and understood as cybernetic system, with a specific structure of its own and a neuronal dynamics based on it, then the same applies to the mental layer: it can also be seen as cybernetic system that has a specific structure from which in turn follows a specific *mental* dynamics, that is: a sequence of mental states, whose regularities relate to the structure of the space of mental states.

So if it is justified to express neuronal states through concepts and relationships which follow from the assumption that neuronal activities must be considered as elements of the cybernetic system of neurons, then it is also justified to express mental states through psychological or mental concepts and relationships which follow from the assumption that mental activities must be considered as elements of the cybernetic system of mental states, that is: the mind.

This, however, means at the same time:

If the assumption were correct that mental descriptions must be replaced by neuronal ones, then this assumption would abolish itself, because then the neuronal description would have to be replaced by the molecular one, this one in turn by the atomic one, and so on. The process of reduction can only end when the fundamental layer is reached – unless there are special reasons for the independence of a specific layer.

But such reasons cannot be found for any layer of reality: what speaks for the independence of *one* layer applies equally to all others.

Though this justification of the specific autonomous description of the mind by mental notions and concepts is *conditional* – it applies only if there is, besides the elementary description, also *any* other appropriate description –, this does not represent a serious limitation because it would be absurd to renounce all other descriptions.

Thus, the just performed train of thoughts is a complete justification of the mental description of mental states. However it does not contain any explanation how this description can be fitted into a scientific context, and for this reason it was merely intended as an introduction, as a preliminary exercise, which is capable of calling current thought patterns into question and is therefore appropriate as preparation for the ensuing analysis of the same scenario.

3.2. The Path to the Reality of the Mind over seven Stages

In order to arrange the following train of thought as clearly as possible, I will highlight the various stages as headings.

Starting point of the analyses is the assumption A_N , which in 2.2 was denoted as *Completeness Axiom of Science*.

A_N : Everything which happens follows from laws and initial conditions.

At first, a note about the prerequisites:

From the physical point of view, reality consists of objects that interact with each other. Initial conditions are the values of the variables of a system – e.g. the positions and momentums of all particles – at any given time, laws are mathematical relationships between these variables, that is: equations.

Here is a more extensive formulation of A_N , by which the assumption of the (possible) structural identity between reality and description is emphasized:

A_N means: *The **information**, which is present **in nature** and which the temporal development of a system depends on, is **completely contained in the initial conditions and equations of the system**. In the same way as in the reality the future follows from the present, the future values of the variables of the equation system follow from the present ones. The system of equations maps the laws, by which is determined how the future is generated from the present.*

The formulation "initial conditions and law" gives first the impression that "the law" is a kind of input-output machine, which, if it receives the exact initial conditions as input, will then produce the correct values (probability distributions) of all variables at any given time. Let us denote this provisional conjecture as

Position 1:

*The initial conditions are singular; the law is general, which means: the initial conditions are entered **once** into the law-machine (inserted in the system of equations), and thereafter the law-mechanism contains the desired result **for any point in time**.*

This expectation is confirmed by some simple classical examples such as a swinging pendulum, or a planet that circles around its sun, or the case of two gravitating bodies which – if they are not disturbed – will perform their elliptical dance for eternity (at least in the Newtonian approximation).

Let us stay with the case of gravitating masses, whose dynamics is determined by their self-generated gravitational field.

In the case of more than two bodies, the situation changes in an essential way. The differential equations are no more integrable, and therefore it is no longer possible to understand the law as mechanism that produces for any input the according output.¹¹⁷ Instead numerical methods must be applied.

How is to be proceeded in the case of – just to name any sufficiently large number – 1000 bodies that move relative to each other and are bound to one another by gravity?

If the initial conditions, that is: the positions and momentums of all bodies, are known at the time t_0 and should be calculated for a later time t_1 , then the time period $t_1 - t_0$ must be divided into intervals; – into how many depends on the desired accuracy: the better the approximation, the smaller the intervals.

One starts with the initial conditions of the first interval and calculates the positions and momentums of all bodies at the end of this interval. They represent the initial conditions of the second interval. Then one repeats the same procedure for any further interval and, in this way, achieves at the end the desired result with arbitrary precision (apart from possible instabilities, which, however, is not relevant for the subsequent train of thought).

What has changed against the previous situation?

Now, the initial conditions no longer appear as incipient one-time requirement for the law-mechanism but as continuously recurring requirement which accompanies the act of information-gathering permanently. If one maintains the claim that the description provides (in principle) *all* information that nature itself needs for its temporal development, then actually initial conditions and law become completely equivalent, because in order to make this information available, the duration of the calculation intervals would have to go to 0.

With respect to the calculation of the path of any single body, the initial conditions turn into *boundary* conditions that change differentially with time – exactly as the position and momentum of the body itself.

¹¹⁷ In the case of three bodies, there are solutions in the form of convergent series. However regarding the argumentation presented here this is irrelevant – we are not interested in special cases of small numbers of interacting bodies, we consider the question of what changes at the transition to *very many* bodies

Thus, the system is governed by *feedback*: the local changes (of the positions and momentums of the single bodies) affect at the same time the boundary conditions (the global circumstances), and accordingly also the effects change, which the gravitational field exerts on the single bodies, that is: their accelerations.

The first assumption must be corrected then, and we get to

Position 2:

Law and initial conditions are equivalent. There is a permanent feedback between global structure and local changes.

Already by this simple first step from position 1 to position 2, the common idea of causality "from below" or "bottom-up" – i.e. the idea that everything is determined at the layer of "elementary particles" has proven wrong. It fits only ideal cases, which are never realized. In real cases, from the causality "bottom-up" alone follows indeed nothing at all; in order to produce information about the future, it needs to be connected with the causality "from above" or "top-down".

The concept of *determination at the layer of elementary entities* must be replaced by the concept of *feedback*, that is: *interaction between local and global conditions*.

For the next step, we change into a different scenario. We consider an oscillating membrane which consists of a very large number of particles that are bound together by electromagnetic forces. At its periphery the membrane is fixed such that it is under tension.

Here we find

1. A natural law: the equations of the electromagnetic interaction.
2. Initial conditions: the positions, momentums and charges of the particles at a specific point in time.
3. Boundary conditions: the *form of the edge of the membrane*, by which its possible oscillation states are determined.

Compared with the previous scenario, something crucial has changed. Previously, the positions and momentums of the particles at the beginning of each time interval represented the initial conditions for the next calculation step. We called them *varying boundary conditions* or *global structure*.

But the boundary conditions referred to in point 3 do not correspond to these boundary conditions of the previous scenario. Instead applies that now the global structure itself is restricted by further conditions – let us call them *boundary conditions of higher order* – in such a way that it obeys a separate, new law: the *oscillation law of the membrane*. The conditions mentioned in point 3 are these boundary conditions of higher order.

The oscillation law of the membrane is not a natural law in the usual sense. It is also not deducible from natural laws. In order to provide a description that contains all information, it must be added *as such* to the natural laws that apply to this scenario.

The independence of the oscillation law from the natural laws is proven by the fact that, for its mathematical description, the physical realization can be dispensed with.

The assertion that there appears *an additional law*, might at first seem strange. Is it not still just the electromagnetic interaction, which determines the movements of the particles and, with it, the movement of the membrane? Is the oscillation law not just a comfortable form of representing the dynamics of a particle-constellation that is *actually* determined by electromagnetism?

The answer is *no*. The electromagnetic interaction represents only *one* prerequisite. But for the complete description, here – as well as in the previous scenario and in all other cases – not only the law but also the *initial conditions* at any given point in time are required, in other words: the *global state of the system*. And while previously it was necessary to subdivide the whole process from start to finish into intervals and to determine the global state for all these intervals anew, it is now possible, due to the *additional law*, to set up an equation that can be solved analytically.

*This means: The new law is the **dominant** law. It determines the global and with it also the local dynamics. The natural law is subordinate: the electromagnetic interaction fits into the requirements of the oscillation law.*

But has not the whole scenario yet originated in accordance with natural laws, such that also the boundary conditions, which are structuring here the global dynamics in a lawful way, ultimately can be derived from natural laws and initial conditions?

Again no. The attempt, to disprove the assertion that now the global dynamics obeys a *new* law by drawing on the past, fails, because in any case, no matter how far back one goes, one has to start with law *and initial conditions*, and then – according to what has been said just before – due to the *ever-changing global conditions* it is impossible to derive the future.

Exactly this fact prevents the derivation of existing systems from natural laws and initial conditions and permits the occurrence of new laws. The natural laws alone do not offer this possibility – they remain always identical. The global conditions, however, which represent a second indispensable element of the organization of nature and its description, are open for the development of regularities, which occur in addition to the natural laws.¹¹⁸

This second step in our train of thought has brought us from the assumption that there are only natural laws to the assumption that the dynamics of the global states of a system is not only determined by natural laws but also by further laws that could be called (as has already been stated in 2.2) *laws of form* or *laws of structure*. To sum up:

Position 3:

Boundary conditions – or, more general: structural prerequisites – can have the effect that the global system-states are subject to laws, which take place in addition to the natural laws. These are laws of form or laws of structure. They are dominant and independent of the physical constitution of the system.

To perform the next step, we now turn directly to human neuronal networks.

The single elements, which they consist of, that is: the neurons, are systems that are comparable to the membrane of the previous scenario in the following way:

The constitution and the structure of the neuron are to be seen *as set of boundary conditions*; as such they determine the dynamics of the physicochemical processes that occur in the neuron, i.e. the dynamics of the system states. Analogously to the *oscillation law* of the membrane, also here a *new law* appears: the well-known *neuronal input-output law*. And also in this case, it is possible to disregard the physical realization.

Position 4:

Neurons are systems whose (internal) dynamics is governed by a law of structure – the neuronal input-output law. Also the dynamics of the neuronal network as a whole follows this law. In this regard, the network is similar to the previously described gravitational scenario whose dynamics was determined by the law of gravitation. The neuronal input-output law can be understood as interaction law of neurons.

¹¹⁸ This argumentation will be completed in the next chapter.

With this, we have arrived at the layer of reality that is the subject of brain research:

The neuronal network is seen as a system whose elements are neurons and whose states are determined by the interaction law of neurons (the neuronal input-output law), in the same way as the states of physical systems are determined by natural laws.

The broad outlines of the dynamics of the network are directly observable. Several imaging techniques show which neuronal areas are active and enable thus insights into the functional topology of the brain. The knowledge of the activity and shape of neuronal structures allows – to some degree – even conclusions about the extent of the associated intellectual performance, particularly in the case of pathological limitations.

The question is:

Does the now reached layer of reality – the neuronal network as system that obeys the neuronal input-output law – already correspond to the layer of the mental activity?

The answer is *no*, and here is why:

Suppose we have the equation (or the system of equations) of a human neuronal network. (Even if this assumption is totally absurd, there is still no reason to rule out the *existence* of such a system of equations.)

Then we are in the same position as before in the case of the system with numerous gravitating bodies. We have *the law*: the system of equations of the network, and the *initial conditions*: the values of the variables by which the states of the individual neurons are defined – exactly as in the gravitational scenario the law and the initial conditions have been given.

Whoever now thinks that from law and initial conditions would already follow the further temporal development of the system, would be subject to the same mistake, by which the provisional *position I* was characterized – that is: the erroneous assumption that the law functions as an input-output mechanism, where the initial conditions could be used as input, and which thereafter – without any intermediate steps – produces any desired information about future system states.

This assumption was wrong in the gravitational scenario, and it is also wrong at the neuronal network, because in both cases there is a *permanent feedback* between the global system state and the local changes, which are determined by the law *and* by the global state.

Let us again compare the gravitational scenario:

The changes in the variables of the bodies – the positions and momentums – result from the structure of the gravitational field, i.e. from the state of the entire system. The law of gravity can be applied to determine the paths of the bodies – however only for a (very) short period of time, because due to the local alterations also the field changes. This change must be taken into account at the next step. The changed field effects now alterations of the positions and momentums, which again represent at the same time a change of the whole field etc. The *singular initial conditions* turn into *variable global conditions*.

Due to this permanent feedback, it is indeed completely impossible to obtain information about the temporal development of the system by inserting the initial conditions into the equations and then applying a method for finding solutions. *Such a method does not exist.*

In the neuronal network, the circumstances are analogous. All elements of the system (neurons) are either directly or over a few intermediate steps connected with each other. The alterations of the variables of the neurons – number of synapses, connection strengths, degree of activation, frequency – are a consequence of the respective global system state, which means: the law (the equation system of the network) can be applied. But just as before, only information for a (very) short time period can be obtained in this way; the local alterations change at the same time the global system state, which in turn acts differently on the local variables etc. And – as in the gravitational scenario – from the existence of this massive feedback follows that there is no method for finding solutions of the equations of the neuronal network.

Position 5:

Due to the feedback between global and local conditions, it is not possible to calculate exact values of variables for any time point in the future.

There is no algorithm which leads from a known state A of the network to a future state B.

Thus it would be necessary, as in the gravitational scenario, to resort to numerical approximations, *unless* there are other laws, which, as in the membrane-scenario, determine the dynamics of the network *in addition* to the neuronal input-output law.

Thus we are faced with the next fundamental question:

Is the interaction law of the neurons – the neuronal input-output law – the only law which the system obeys, or are there further laws of the kind that previously has been called laws of structure?

In other words:

Is, as in the gravitational scenario, the interaction law of the elements of the scenario the only law, or occur, as in the case of the oscillating membrane, further laws due to *structural preconditions* – laws, that is, which determine the global system states?

The answer is simple. As follows:

"Mental states"¹¹⁹ are defined as global states of the neuronal network, where many areas of the network are simultaneously activated and connected with each other.¹²⁰

With this, the conditions are comparable to those of the oscillating membrane. The structuring of the network by the therein possible mental states can be understood analogously to the structuring of the membrane by its possible vibration states. In the case of the membrane, the edge represents the condition for the occurrence of organized global states, in the case of the neuronal network, the *form of the whole network* (more precise: of the state space of the network) represents the structural prerequisite for the occurrence of organized global states (patterns) of the network, that is: of mental states.

Position 6:

In addition to the neuronal input-output law, the neuronal network follows a further law: its dynamics is structured by the global patterns that are defined as "mental states". Their structuring function can be understood analogously to the one of global oscillation states of a physical system: like those, mental states are attractors of the global dynamics. (More to that in 3.4.)

¹¹⁹ Here, I use the term "state" analogously to the term "oscillation state" of the membrane, i.e. synonymously for "spatio-temporal pattern". Thus, a mental state is extended in time – in contrast to a physical state, which relates only to a certain point in time.

¹²⁰ As a further condition must be assumed here that parts of the network are active, which have no specific function (so-called associative arrays). Only if that is the case, then the global states can also be mental states, and only then apply the following considerations. (At the end of 3.5, I will return to this point and again enter into it in the 5th chapter.)

The next step leads beyond the membrane analogy:

In the same way as it can be assumed that mental states are organized global system states, it is also clear beyond doubt that they refer to each other, so that they *form their own network*.

This means: While the transitions between the various possible oscillation states of a physical system are caused from *outside*, the transitions between the organized global system states of a neuronal network – the mental states – are part of the *internal dynamics* of the network.

The transitions between the global states – as well as the states themselves – cannot be derived from the neuronal input-output law: If the transitions were derivable, then also the whole sequence of the global states would be derivable, and then would follow that also the elements of this sequence, i.e. the states themselves, could be derived from the neuronal input-output law. However, as stated just before, they do not follow from this law but from a *new law of structure*.

Accordingly, to the mental states must be assigned *their own dynamics*.

In other words: Mental states relate *as mental states* to each other. They are connected with each other by a specific *mental* interaction, not other than particles are connected with each other by a specific physical interaction.

With this, we have now, without ever having had to leave the area of scientific model formation, systematically justified the assertions, which have already been presented in the previous section 3.1.

Here the repeat. It is at the same time the

Position 7:

Like neurons or neuronal modules, mental states are networked with each other, they cause each other, they determine their own temporal sequence, in short: they form their own self-dependent layer of reality.

Just as the description of the neuronal dynamics permits to abandon the material condition of the cybernetic elements (the single neurons) – that is: that they are aggregates of molecules –, also the description of the dynamics of mental states permits to abandon the material condition of the cybernetic elements (the single mental states), that is: that they are global neuronal patterns.

ONLY NOW we have reached the layer of mental activities, that is: the mind.

Only by realizing that the global patterns of the network form a *structure of higher order*, mental phenomena *as such* can be integrated into the scientific view of the world.

Basically, the step from position 6 to position 7 is not a new move – it represents merely an analogy to the rising from molecules to neurons. It is another example for the fact that aggregates which consist of simpler elements in turn can form the components of a higher layer, which means: they can act as elements of a dynamic structure of higher order. In exactly this way, the global patterns of the network must be understood as elements of a higher layer of reality.

To the cursory glance, this fact could remain hidden, because this layer of reality is never present *as a whole*. Indeed the neuronal network does not contain the activation patterns themselves, but only the *construction rules* for these patterns. Therefore, of all possible mental states, only one at a time is realized.

While the neuronal network as a whole – as cybernetic system – exists at any time, such that its structure is (in principle) completely visible, the network of mental states cannot be observed directly.

As an example of mental activities, let us consider a *train of thought*. In our picture, this is a sequence of organized system states. Any thought is a pattern or already a sequence of patterns. In each case, only one of all patterns which represent the thought train is realized. It is active for a short time and then the change to the next pattern takes place. This subsequent pattern, however, can possibly be realized *in the same neuronal areas* as the previous one. Thus, at a resonance tomography, this transition would not at all be observable.

Therefore, if one aims at investigating the structural connections of mental states, then this cannot be carried out by observing an existing structure. Rather it is necessary, to consider a *virtual* space, which however (in principle) could be visualized by a model. Its elements would be mental states – ensembles of thoughts, feelings, perceptions etc. – and its structure could be indicated by arrows, which lead from any state to the possible following states, with information about the probability of each transition.

Thus, the structure and the dynamics of the mental activity cannot be visualized by any imaging technique. In order to gain an overview, one has to enter the virtual space of mental states.

Basically, imaging techniques can only inform about the activities and sequences of states of the network which are determined by the neuronal input-output law and by the functional architecture of

the brain, and *not* about the activities which are determined by those regularities that apply to the sequences of mental states, e.g. to trains of thought.

Thus it is understandable that in brain research, provided that it is based on imaging techniques, never conclusions, thought processes or insights are considered, which actually represent the true realm of the mind.

Let us look briefly at what has been achieved. How far have we come?

From our analysis follows the autonomy of the mind. It has been shown that mental activities can – and indeed *must* – be described *as such*. In doing so, we have not come into conflict with the scientific view of the world; on the contrary, the argument was referring only to scientific facts and methods.

With this, the description of mental phenomena by the terms that we use every day is completely justified. Thoughts are thoughts, reasons are reasons, decisions are decisions. That they can appear *as they themselves* and need not be *something different* is because they are not reducible to anything else. And the reason for that is simply the same as in the case of the oscillation states of the membrane: like these, also mental states obey an additional, new law and can therefore not be reduced to another, simpler layer of reality.

In short: the assertion is wrong that mental activities are *neuronal phenomena*, just in the same way as the assertion is wrong that the oscillation states of the membrane are *electromagnetic phenomena*.

Thus, mental phenomena are *new, irreducible phenomena*, whose independent description is not only justified but necessary.

It should particularly be emphasized that through the foregoing findings not only the autonomy of mental phenomena is justified, but that they permit also to understand mental states as *causes* of physical events. Now, a statement like: "This person acted in this way because he/she thought it right." is equally justified as the statement: "The red ball was pocketed because it was hit by the white ball at the correct angle." Both statements are appropriate causal descriptions of the occurrences in the respective layer of reality.

As a reminder: the justification consists of two facts. The first one has been revealed already at the transition from the first to the second position: regarding the future development of a system, the global state of a system is of equal relevance as the local conditions (as e.g. positions and momentums of particles).

The second fact is that there are systems, the global states of which are determined by laws that exist in addition to the natural laws. If this is the case, then the new law is dominant, and, accordingly, the global states dominate over the local conditions. Thus, it is appropriate to see them *as cause* of the local dynamics. In exactly this sense, mental states are causes of the changes of the neuronal variables and, with it, also causes of actions.

In this simple way is explained how "mind" acts on "matter".

Thus the mental states and processes themselves have become part of the causal nature, but not in the way they appear in the classic antinomy of freedom and causality, not as *caused* but as *causative*.

(Whether or to what extent they themselves are caused, will be answered in the next section.)

Also the emergence of *reasons* can only be understood if one considers the fact that mental states are networked with each other, so that they themselves represent elements of a further layer of reality, of a system of higher order, which has its own dynamics, that is: sequences of states that obey certain rules of their own. *Reasons* are examples of such rules.

However, in the foregoing considerations, important distinctions are missing.

For example, it is clear that not all states of neuronal networks can be regarded as mental states. Simple neuronal networks function like machines. They are completely determined by their circuits – that is: by the neuronal input-output law – and by their functional architecture. Thus it would be desirable to clarify under which conditions the used analogies and arguments apply. (In section 3.5, in the notes, I'll make up for it.)

On the other hand, our intention was to substantiate the *principle possibility* of understanding mind as natural phenomenon and to integrate it into the scientific world view, and exactly that is the result of our previous thought trains: they demonstrate that this possibility exists. Mind can be understood as an autonomous layer of reality, which cannot be reduced to any other, deeper layer (of neurons, molecules etc.). Therefore, psychological and mental concepts and notions are appropriate, and mental processes are causes of physical changes.

What is still missing, however, is the substantiation of the *freedom* of the mind. Though it is justified to regard decisions as mental phenomena, at the current level of our considerations it is still not justified to call them *free*.

3.3. The last Step: the Substantiation of Free Will

Before our view now the following scenario is laid out:

The neuronal network consists of several superimposed layers of increasing complexity.

The bottom layer – let us call it the *field of first order* – is that of **atoms** and **molecules**. They obey a law of nature: the *law of the electromagnetic interaction*.

Their dynamics (within the neurons), however, is governed by a *law of second order* (a law of structure): the *neuronal input-output law*.

The middle layer – the *field of second order* – is that of **neurons**. They obey a law of structure: the *neuronal input-output law*, which is also their *interaction law*.

Their dynamics, however, is governed by a *law of third order* (a law of structure): the *law of the sequence of mental states*.

The top layer – the *field of third order* – is that of **mental states**. They obey a law of structure: *the law of the sequence of mental states*, which is also their *interaction law*.¹²¹

In this scenario, however, there is one point that needs to be supplemented. I'll be right back on it. Let us first assume that all statements are true.

Now we add to these statements another statement – the one derived in section 2.2. It reads:

Of the two assertions

1. *Free will exists*
2. *The Completeness Axiom of Science A_N is correct*

at most one is true.

¹²¹ It may be surprising that the layer of neuronal areas of different functionality is missing, which also interact with each other according to specific laws. The inclusion of this layer as a further field of order, however, would change nothing fundamental, but merely complicate the argument. Therefore, this layer appears here only in the form of the condition that in mental states associative arrays must be active.

As a reminder once again the completeness axiom:

Everything what happens follows from initial conditions and laws.

Let us review the just depicted scenario. Obviously, in the form as just noted, it is in fact entirely determined by initial conditions and laws, and from that would now follow – as stated in 2.2 – that the assumption, *we ourselves* would be authors of our actions and choose them according to our free will, would be as absurd as the assumption, not only gravity but also a *many-armed cosmic monkey* would guide the heavenly bodies at its discretion.

So let us examine whether any of the allegations, which the scenario contains, may be incomplete or incorrect.

Let us start with the initial conditions. Their existence is taken for granted. On the hierarchical structure, there is also no doubt.

Thus the problem must lie in the law assumptions.

Three types of laws of different orders occur: the *electromagnetic interaction*, the *neuronal input-output-law* and the *law of succession of mental states*.

The first two laws exist with certainty. Regarding their definition, there is no problem. They always apply unchanged.

Through this process of elimination, we have identified the problematic point in the scenario – it is the only remaining assumption, that is: the statement:

There is a law that governs the succession of mental states.

What is problematic about it? Can there be any doubt that mental processes follow certain rules?

Let us examine what happens when mental processes run. According to our assumptions, their course follows a law of third order.

Now we include in our consideration the known fact that *any neuronal activity alters the neuronal structure*. The active patterns are reinforced, non-active patterns are attenuated – which can be effected

through changes in the neuronal synaptic activity, but also through growth or reduction of dendrites or even formation or degradation of neurons.¹²²

This means:

The mental activity acts back on itself. It alters itself by changing its neuronal code: through the activation of one single mental state, all other mental states where the neuronal areas in which they are encoded overlap with the ones of the active state, undergo an alteration. (Since each mental state is distributed over a wide range of the network, the areas of many, if not all mental states overlap each other.)

With this, also the rules of the sequences of mental states change.

For comparison: though in processes, which occur in physical systems, continually new states are produced – i.e. the values of the variables change –, still the laws remain the same, and also the structure of the state space remains unchanged, provided that external influences can be excluded.

In contrast, in the case of mental processes not only new states are produced but also *new rules* of the sequence of these states, and accordingly the structure of the state space is constantly changing. Even if external influences are excluded, the system modifies its own preconditions incessantly through feedback. And this modification – though Hebb's law is its necessary condition – must be attributed to the dominant layer of the scenario, that is: to the mental layer. It is a *mental* phenomenon.

Therefore, there are no fixed rules of third order.

Still, another question must be clarified: Are there perhaps constant *meta-rules*, i.e. rules about the changing of the rules of the activity of the mind?

The existence of *universally valid* meta-rules would presuppose a universally valid relation between the information-content of mental states and its neuronal encoding. But such a relation does not exist. This means: if meta-rules exist, then they are related to the specific system, and from this follows, that they are also subjected to alterations by feedback.

¹²² This insight traces back to Donald Hebb, who noted in 1949 in "The Organization of Behavior": *When an axon of cell A is near enough to excite B and repeatedly or persistently takes part in firing it, some growth process or metabolic change takes place in one or both cells such that A's efficiency, as one of the cells firing B, is increased.*

Therefore, there are also no fixed meta-rules.

We have thus deduced the following statement:

The formal representations of mental processes cannot be derived from any given system of initial conditions and equations. If such equations or rules for these representations and their transitions exist, then they are continually altered by feedback-processes.

Since the encoding of mental states takes place on the neuronal layer, and since the elements of these layer are in turn composed of physical elements, from this statement follows, as announced in 2.2, also the statement:

The physical states and sequences of states, through which mental processes are represented in neuronal networks, are not derivable from any given system of equations and initial conditions and cannot be regarded as a solution of such a system for any given time.

Thus the Completeness Axiom of Science is wrong.

Precisely because mental processes are natural processes, the following applies:

Any formal description of nature by a given system of initial conditions and laws is incomplete.

If the Completeness Axiom is wrong, then freedom of will *can* exist. Does it exist?

The answer is *yes*, and this answer consists of three statements that have been derived previously:

1. Volitional decisions are mental processes. As such, they are not derivable from physical circumstances, and this does not apply due to technical reasons but due to principle – or say: metaphysical reasons.
2. Volitional decisions act *causally* upon material circumstances.
3. Though mental processes obey their own rules, it is still impossible to derive any volitional decision from these rules: it cannot follow from them, because they can be changed by the mental process that precedes the decision. While this process runs, the laws which it obeys can change – or more precisely: *the process itself* can change the laws that applied before it started.

In summary: volitional decisions are causes of actions, and they are not predetermined.

So they are free.

3.4. Organized States in Neuronal Networks; Universals as Attractors

In the last section, mental states were called *organized states of a neuronal network*, by which the dynamics of the network is governed. This can be understood as *causality top-down*.

This issue is to be concretized.

I am going to use models that are simplified and idealized to such a degree that they hardly deserve the label "model".

The justification of this method is that it permits to explain fundamental properties of neuronal networks in a particularly simple and abstract way and to demonstrate how these properties are linked to mathematical principles and how they can rise to intellectual performances.

Imagine a natural (biological) neuronal network of, say: some ten thousands of neurons, which has no specific functionality and is therefore, in this sense, unstructured.

At first it is isolated, i.e. without any connection to the outside. Its electrical activity is weak, and it is random, which means that the trajectory in the (physical) state space of the network exhibits no discernible patterns.

We connect the network with the external world through a sensory organ or an input device, which converts optical signals into neuronal activity. The state of the network now depends on this optical input.

Now we present an *object* to the input device over a certain time period. We assume that, due to this specific input, a pattern is generated that persists (or is repeated) as long as the object remains in place.

Now follows the point that is crucial for the structuring of the dynamics of the network:

*Due to Hebb's law, the neuronal connections, which form the currently active pattern, are **reinforced**.*

Mathematically, this means that *the active pattern turns into an attractor*.

With this, the state space of the network has changed: It is no longer unstructured, but has an attractor that represents an object.¹²³

The attractor has a *basin of attraction*. So there is now a part of the state space within which the trajectories are not random but approach the attractor.

From this concept directly follow some fundamental statements, which apply not only to our simple network model, but generally to neuronal networks where an area exists whose dynamics is not predetermined (genetically) from the very beginning but develops – as just described – in the course of time through the formation of attractors:

1. The concept "attractor" meets exactly the conditions that have been postulated with respect to mental states, i.e. that they are *organized states*, which are *structuring the state space of the neuronal network* and in this way *determine the dynamics of the network*.

If mental states are understood as such attractors, they are indeed comparable (in this respect) to the oscillation states of a membrane, which also represent attractors of the state space of the membrane.

Further conclusions can be drawn:

2. It holds that: *perception = recognition*.

The reason for that is that the basin of the attractor provides a definition of *similarity*: any new input, which causes a neuronal state that lies in the basin of attraction, is *sufficiently similar* to the original input – i.e. the object by which the attractor has been generated – that this new input can be identified *as the same object*. Due to the fact that the point lies in the basin of attraction, the trajectory will first approach the attractor and then move along the attractor, which means: the original pattern, which represents the object, is formed once again.

This means: in the case of a sufficiently similar input, not just a *similar*, but indeed *the same* pattern emerges. And because no object can, if it reappears, provide an identical input as at its first appearance

¹²³ That a neuronal excitation pattern, which is active for a sufficiently long time period, will be an attractor is not a hypothesis but a fact: it is simply the mathematical expression of the proven neuronal fact that an active pattern is reinforced.

– some variables will change with certainty –, the attractor-concept is necessary for understanding the recognition of objects.¹²⁴

In artificial neuronal networks, which for example serve for face recognition, such a convergence of patterns is superfluous: here the output need not have a specific value, it is sufficient that it lies in an interval. However this "rasterization" of the output field is defined from outside – by the programmer; In biological networks, there is no rasterization, and therefore, for any kind of recognition, a convergence of various input-caused states to one single pattern is required, which subsequently can serve as output for further processes.

Of course, in natural neuronal networks also attribute analysis takes place. Yet again: no attribute produces a completely identical input on several occasions, and therefore it is again necessary to recognize that which is only similar as the same; And accordingly, the assumption is required that not only the object as a whole but also its attributes are represented by attractors.

3. The attractor concept also casts light on the philosophical question of the status of universals. As follows:

As just illustrated, objects are represented by attractors. If now the same principle is applied to the representations themselves – by assuming that these representations themselves are in turn *internally* represented (in the neuronal network) by attractors –, then the level of *concepts* is reached.

If a concept is understood as neuronal attractor, then again similarity will be defined by the basin of attraction, and all object-representations that are in this way similar to each other, will be assigned to the same concept.

¹²⁴ Unless one assumes that the current pattern is somehow *compared* with already existing patterns. But how should such a comparison take place? This would require, that not only the current pattern but additionally a number of already existing, known patterns needs to be activated, such that the comparison can be performed. This is unlikely, and moreover it is still unclear how this comparison could actually be carried out.

In contrast, the explanation of recognition by the attractor concept seems simple and logical: an object is recognized, even if the input is changed in some variables, because yet again the same attractor, i.e. the same neuronal pattern, is formed. It is then immediately evident, how to an input, which – even if it occurs as the result of the same object – can never be identical, always the same object is assigned. (This pattern formation, however, must take place in the visual memory and not – as could be concluded from our too simplistic model – in the field of view itself)

From this follows:

Universals are constructs that result from the regularities of neuronal representation.

If objects and attributes of objects are indeed represented in the neuronal network by attractors, then we are not at all able to perceive individuals (i.e. single objects) *as such*. We recognize not the Individual, but only the General. We are just deceived by the fact that, in most cases, only one single object of our everyday environment lies in the basin of attraction of a specific attractor. However the example of twins shows immediately that this is not always true.

The same applies to thought: just as we can only *perceive* the General, we can only *think* the General.

It we *mean* something individual, then what is meant appears as individual either because of its localization in space and time, or because it is the only object that meets all general requirements by which it is defined, in other words: it lies as a whole and in regard to all relevant attributes within the basins of the respective attractors.

Let us return to our initial neuronal network. Let us assume that the optical input will now no longer be generated by a single object, but by a series of consecutive objects.

Each of these objects corresponds to a neuronal pattern. The set of objects is thus represented by a series of attractors.

If these objects serve repeatedly in the same order as input for the network, then also the transitions between the respective neuronal patterns – more precisely: the neuronal connections that mediate this transitions – are reinforced

Formulated mathematically: the trajectories in the state space, which lead from one attractor to the respective next one, turn into *attracting trajectories*, in the sense that trajectories which are sufficiently close will approach them. This means: The state space of the network is now not only structured by attractors, but also by trajectories that lead from one attractor to another – in other words: the object-representations are linked associatively.

We now extend the model in the following way: In addition to the first area, which is connected with the outside world, a further neuronal area exists that receives an input which represents the *body information*. Though the two neuronal areas are connected together, they work largely independently.

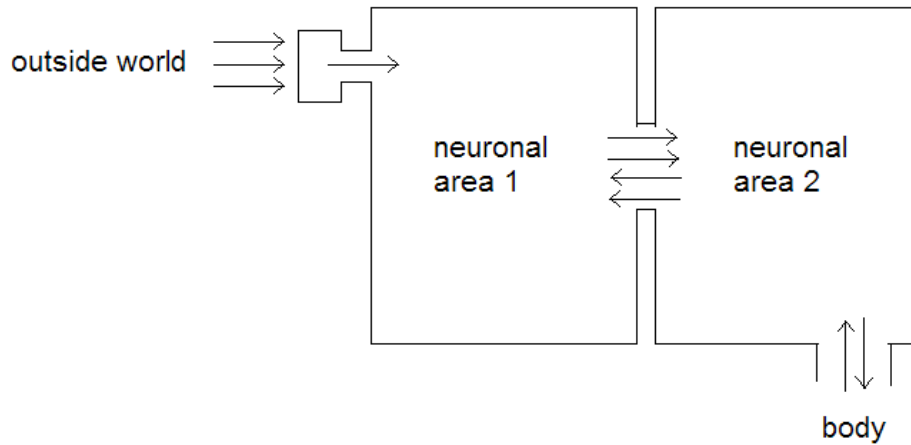

What has changed thereby?

Now the state of the network depends not only on *information from outside*, but also on *body information*. It consists of two attractors, which are connected by neurons with each other and permanently exchange information, so that the variables by which an attractor is defined depend also on the other attractor. In this way, inside and outside information is connected. Also the state of the whole network can be understood as attractor.

At this point, an important feature of attractors comes into play: even if the initial conditions are only partially realized, the neuronal patterns, to which they correspond, will still emerge. A subset of the variable values that belong to a point in the basin of attraction represents a sufficient precondition for the formation of the attractor.

In our context, this means the following:

If an object (or a situation) and a body condition occur several times in common, then – as a result of the neuronal connection between the two areas – later the pattern that develops in one of two areas alone is already sufficient to induce the according attractor in the other area. Thus the attractor that represents the object information induces the attractor that represents the body information and vice versa.

If one assumes that not only the body controls the network, but also the network the body – which in the drawing is indicated by the arrow leading down – then the object affects the body condition:

Initially, that attractor is formed that represents the object; this attractor induces the one in the other area, and that one generates the associated body condition.

Through these relations, objects (and situations) are associated with body conditions. The body information thus represents an *evaluation* of the objects: depending on the type of excitation of the body, the objects are assessed positively or negatively. Moreover, the extent of the reinforcement of the active patterns depends on the degree of excitation.

Now the following must be considered:

The neuronal patterns that represent objects are attractors in the state space of the network, and the associative connections between the object representations are attracting trajectories in this state space. Therefore, they are structures that exist *in the network itself*, and this means that – even if no input is present – the dynamics of the network is determined by these structures.

Thus the network generates – by itself and independently from any input – sequences of representations which are connected with body information.

This can be seen as basis of *intentionality*.

With this, the possibilities of our simplified model are largely exhausted. After all, they were sufficient to justify the concepts of the previous section, where they have been presented in a completely abstract way, and to lead them a bit closer to reality.

Through its ability to generate a specific pattern also from altered or even fragmentary initial conditions, the attractor concept permits to understand how mental states, such as representations or ideas, are strung together to associative sequences. Indeed, "associative linked" means nothing else than "connected by a trajectory in state space, which has been run through repeatedly and is therefore reinforced".

I want to finish this brief excursion into the regularities of neuronal networks with some general remarks about the status of scientific descriptions of features of neuronal networks.

On the one hand it is clear that, due to the complexity of human neuronal networks, it is not possible to analyze mental phenomena mathematically or replicate them artificially. The complexity is so high that it is neither theoretically nor technically manageable.¹²⁵

¹²⁵ In chapter 5. *Qualia* will be shown that the simulation of the mind is impossible for *principle* reasons.

On the other hand, it is simple and largely unproblematic, to obtain a basic understanding of how mental features and performances can be brought forth by neuronal networks.

An example: We understand – though not in every detail – how objects of reality are perceived visually. We know the physical processes through which the information reaches the retina and from there via the visual path the primary visual cortex, we know how the entire object information is broken down into various components – color, texture, characteristics, contrast, shape, motion, orientation, depth –, which are first processed separately and then brought together again. This knowledge gives us a basic understanding of how information is encoded in neuronal networks and how this encoding allows object representation.

Another example: awareness. It is possible to understand awareness in a simple and consistent manner by assuming that it is a meta-representation, i.e. a mental state, which is characterized in that the information content of states of the neuronal network itself is in turn represented and further processed in another area of the network.

From the assumption that the information content of perception states is a representation of cutouts of reality, it is not a big step to the assumption that, in neuronal networks of sufficient complexity, also the information content of *inner states* can be represented in the same manner. The possibility of such a meta-representation requires only the existence of another, hierarchically higher level of information processing.

Generally, it can be argued that the understanding of mental phenomena, which is based on the assumption that neuronal networks are information-processing systems, does not lead to any fundamental scientific or philosophical problems – provided that this assertion relates only to the *information content* of mental states and not to their *feeling content*. (Why mental states are *qualia* will be answered in the 5th chapter.)

Note:

I emphasize again that the models presented in this section are unrealistic simplifications. Nevertheless, they serve their purpose: to show, how the structure of the state space of a neuronal network develops and how the neuronal processes are determined by this (at least short-time constant) structure; – and this is the core of the argument that here causality acts top-down, that is: from mind to matter.

3.5. Summary

Since the conclusions that have led to freedom of will, will once again be presented in the next chapter in more general terms, I can be brief here.

What is the reason that a middle c is heard, if I strike the tea cup, standing in front of me, with a spoon? What is the cause of the character of this tone?

Not the fact that the cup consists of particles, nor that the particles interact electromagnetically. No, the reason for the height and character of the tone is the *form* of the cup.

From the interaction law follows only the speed of propagation of the initial disturbance. Together with the form of the cup, it determines the pitch. The character of the tone – the specific overtone structure, i.e. the *oscillation pattern* – is entirely dependent on the shape of the cup.

Already this simple example demonstrates that, in systems whose dynamics is determined by boundary conditions, in addition to the specific laws of nature, laws of form occur. These laws are dominant. The global state of the system is the *cause* of the local events; thus, causality does not act bottom-up but top-down.

Analogously can be understood that mind is the cause for the dynamics of human neuronal networks and therefore also the cause of human behavior and the according physical changes.

Mental states are organized states (patterns, attractors) of human (and of some animal) neuronal networks. As such, they determine the dynamics of the network. But while the cup has a trivial dynamics – it has only one single (oscillation) state – in the neuronal network there is a tremendous number of possible mental states and transitions between them.

These states are not derivable from the neuronal input-output law (as the state of the cup is not derivable from the electromagnetic law), and the same applies to their transitions.

This means: mental states are related to each other *as such*.

Therefore, the area of reality that we call "mind", is a self-dependent layer of reality, which must be attributed its own dynamics. The laws of this layer are dominant. What happens in the network is therefore caused by the mind and not by neurons and the neuronal interaction law or by the functional architecture of the network.

To learn what is going on in the network, one has to refer to the respective mental activity and its individual rules. Among these rules are, for example, *reasons*.

Thus, asking someone for his/her reasons to find out what he/she will do is as justified as determining the point where one billiard ball hits another one in order to predict where the ball will move, or as determining the form of the cup in order to calculate its sound.

Generally speaking: *for the knowledge of the dynamics of a system, the dominant laws of the system must be known. In the case of human neuronal networks, these are the (subject-specific, variable) laws of the mental activity, which belong to the respective network.*

At this point of our train of thoughts, the phenomenon *mind* is completely reestablished, in other words: mind is resurrected as the phenomenon as which it is given to us intuitively.

To obtain this result, it was particularly important that we have liberated ourselves from the common confusion of *neuronal activity* and *mental activity*.

In order to get to the justification of freedom, an additional step is required.

Prerequisite is the statement: The laws of mental activity determine the dynamics of the network.

If these laws were *fixed* – like physical or neuronal laws – then freedom would not exist. But this is not the case, because the mental activity *acts back on itself*.

The physiological precondition of this feedback is Hebb's law: adjacent neurons, which are activated simultaneously, change in such a way that their mutual stimulation is reinforced. Conversely, unused connections are reduced. Thus, the mental activity changes its own preconditions. It acts back on its neuronal encoding, and, with this, changes its own laws.

Therefore, in the system of mental states, not only new states are generated – as is the case in physical systems – but also new laws. The system enters a feedback loop. The rules to which the mental activity is subjected are changed by this very activity.

So there are no fixed rules which determine what will happen.

This means: Volitional decisions do not follow from any system of initial conditions and laws.

If nature is seen as such a system, then, in this system, volitional decisions that will happen in the future – as well as all other future mental processes – are *undecidable statements*. They cannot be derived in the system, and the same applies to *any* such system.

Thus there is room for freedom.

To arrive at a final judgment on free will, we define volitional decision:

A volitional decision is a mental process, where

1. the consequences of alternative actions are evaluated and
2. the alternative is chosen, which is judged as the better.

The following statements have been deduced:

A1: Mental states cannot be derived from physical or neuronal laws and initial conditions. They are networked with each other and form an autonomous layer of reality that has its own laws which, however – in contrast to physical laws – are not fixed. Among these laws are e.g. reasons.

A2: Causality acts top-down. Mental processes cause neuronal processes.

A3: Even if the information, which is contained within an arbitrary temporal section through a human neuronal network, could completely be transferred to a system of initial conditions and fixed rules, future mental processes could not be derived in this system. The future is open.

The statements A1, A2 and A3 suffice to substantiate freedom of will in the usual sense.

Moreover, they define what freedom in the metaphysical sense means, that is to say: freedom in a nature that unfolds in accordance with laws.

Notes

The difference between *mental* and *neuronal* processes

Obviously, there are also processes in neuronal networks, which are not determined by the mind, that is: not by the network of the relationships between the mental states themselves, but by the functional architecture of the neuronal network, by the neuronal input-output law and by external circumstances. In simple neuronal networks, *only* such processes take place.

The occurrence of mental states – and with it the dominance of the mental over the neuronal – is only possible, if the neuronal network contains areas, which are *functionally unbound*.

Only areas of this kind, in which therefore – as was also postulated for the simple model network at the beginning of this section – the neuronal activity is not determined by physiological functions but is at first random, are open for the structuring by those organized states (attractors) that represent outer (real) or inner (bodily) circumstances.

However states, which represent something, are not yet mental states. Mental states must also *relate to each other*. Only through this internal network of relationships they become what they are.

Therefore, representational states can only turn into mind when they network with each other. Evidently, the existence of functionally unbound neuronal structures is a necessary condition for that.

The assumption that mind can only appear in living creatures who have sufficiently developed areas of this kind, is also supported by experience with animals. Their intellectual performance depends on the size of the cerebrum, and only in the cerebrum there are such areas.¹²⁶

The difference between mental and neuronal processes can also be characterized in the following way:

Neuronal processes can – at least to a large extent – be observed, measured and predicted.

In the case of mental processes, this is only possible to a very small degree.

¹²⁶ The term "cerebrum", however, must not be tied to the physiological structure, which in humans occurs under this name. In birds, this structure is poorly developed, so that their intelligence has been underestimated for long. Instead, they seem to have enhanced the basal ganglia, and the remarkable intelligence of some bird species despite their small brain size suggests (and gives hope) that *this* neuronal tissue – or this kind of "cerebrum" – is more appropriate for thinking than the human one.

And if the mental processes are *thought trains*, then there is only one method to learn something about them, that is: to ask the one who thinks for his/her thoughts.

The extent of mental activity

Mental states are not present in neuronal networks from the beginning. They need to develop.

To a certain extent, this development probably follows from the properties of the neuronal system.

However what goes beyond this minimum depends on whether education and cultural conditions favor the development of mental activities.

The same applies to the freedom of the will. It exists only when the consequences of alternative courses of action can be judged, and this ability presupposes knowledge and discernment.

Whatever one's position is on the current concentration on the material (genetic, neuronal, chemical, etc.) preconditions of the personality and of thinking – it will in any case contribute to reducing the independence of mind. Mind exists only in the degree to which it is understood as an autonomous reality and practiced as such.

With phenomena such as free will or responsibility, it is the same as with other mental features, e.g. language: if they are not acquired – and there are often critical phases, after the end of which the respective ability can develop only incompletely – then they exist just rudimentarily or even not at all.

Closing

As it turned out, philosophers arguing

- that in the mental area reasons apply and not (physico-chemical) causes
- that scientists equating mental and neuronal processes and therefore producing grotesque statements like "the brain decides that ..." are trapped in a categorical failure
- that free will as subjective certainty can never be abolished by scientific argument

have been perfectly right. However, against the raw onslaught of natural science, their true and beautiful assertions oppose just as little as the chant of the druids against the attack of the roman legions. It is simply a fact that hitherto there has not been any possibility to unite those two kinds of phenomena that seem so self-evident to us – the objective and the mental ones – in a single conception of nature.

For centuries the difference between them has appeared as an insurmountable discrepancy.

The historical attempts to solve the contradiction are no longer viable. Descartes' dualism – as well as all other metaphysical or religious dualisms – would simply be absurd, and understanding the contradiction as Kant did – as unsolvable antinomy –, is not acceptable in light of the enormously grown knowledge about nature that urges us to understand nature as a unity.

The consequences are reductionisms and functionalisms based on scientific modeling.

The scientific paradigm is indeed not only enormously successful, but also appears to be of convincing completeness: nothing escapes the laws of nature.

The ideas of mind, ego and free will are in danger to choke on this stranglehold. If even their inner certainty and self-evidence cannot protect them against the infringements of natural science, then any philosophical arguments will not succeed either.

No – if there are any limits for the scientific paradigm, then they must become clear out of it itself.

That is exactly what we achieved. The Physical and the Mental can be understood in a single model based on scientific and formal arguments, and, moreover, not in the form of functionalism or

reductionism but according to our experience, where mental phenomena are given as self-dependent and different from objective phenomena, but nonetheless both in a complex interdependency.

With this, science has lost its claim to be all-comprehensive. We have demonstrated that formal description is not applicable to mental phenomena.

4. The modified Picture of Reality

4.1. Preliminary Note

Reality, as it is presented in this work, appears *deterministic*: everywhere and anytime the fundamental law is in effect.

But at the same time *free will* exists.

According to conventional conviction, these two facts contradict each other.¹²⁷

The arguments, through which this contradiction is eliminated, have been presented in the previous section. Since there, however, they served for the building-up of the specific train of thought that was required at this point – such that they appeared only implicitly –, I will present them now again, but this time more general, more detailed and explicitly related to the contradiction.

Moreover, I will discuss the consequences that these very arguments have for the understanding of reality.

In order to keep the argumentation on free will independent from my own physical and ontological hypotheses, I've avoided drawing on them in the previous considerations. As long as possible, I will continue to act in this way.

Finally, however, it will be necessary to resort to my assumptions, because without them the picture remains incomplete.

¹²⁷ Some philosophers think, however, that this contradiction is a pseudo-problem, which arises only because of the improper confrontation of the subjective and the objective-analytic point of view. Already at the beginning of chapter 2. *Mind and Matter*, I have stated that such a simple separation of the two views cannot be maintained in the face of our increasing knowledge about neuronal networks. It is obvious that we ourselves are part of nature and that our mind must therefore be related to the scientific description of reality. The retreat to the claim of a fundamental separateness of the two views is not a serious position.

On the other hand, most scientists – also brain researchers – are convinced that the phenomenon *mind* can completely be explained by a scientific-technical description. Also this position, however, represents an inadmissible simplification: mental states are *qualia*, and as such they are not contained in any description of reality.

4.2. Free Will and Determinism

In 1814, Pierre Simon de Laplace formulated the deterministic view of reality in his *Essai philosophique sur les probabilités* as follows:

"Nous devons [...] envisager l'état présent de l'univers comme l'effet de son état antérieur et comme la cause de celui qui va suivre. Une intelligence qui pour un instant donné connaîtrait toutes les forces dont la nature est animée et la situation respective des êtres qui la composent, si d'ailleurs elle était assez vaste pour soumettre ces données à l'analyse, embrasserait dans la même formule les mouvements des plus grands corps de l'univers et ceux du plus léger atome: rien ne serait incertain pour elle, et l'avenir, comme le passé, serait présent à ses yeux."

("We ought then to regard the present state of the universe as the effect of its anterior state and as the cause of the one which is to follow. Given for one instant an intelligence which could comprehend all the forces by which nature is animated and the respective situation of the beings who compose it – an intelligence sufficiently vast to submit these data to analysis – it would embrace in the same formula the movements of the greatest bodies of the universe and those of the lightest atom; for it, nothing would be uncertain and the future, as the past, would be present to its eyes. ")¹²⁸

This statement is currently regarded as twofold obsolete: first, due to quantum mechanics, and secondly, due to chaos dynamics. In the case of quantum mechanics – at least in the usual interpretation – it is the objective randomness of the events that makes a precise knowledge about the future impossible, in the case of chaos dynamics, it is the fact that arbitrarily small differences in the initial conditions can result in large differences in the development of a system.

Both corrections of Laplace's worldview are often used as arguments for the freedom of the will, in the sense that they would create room for freedom. But actually, they are irrelevant for the question of free will. In the case of quantum mechanics, for substantiating freedom would have to be assumed that the will itself appears as *hidden parameter*, which need not seriously be considered. In the case of chaos dynamics, the predictability is indeed limited, it may even be completely lost, but for the question of free will, this is irrelevant: If nature *is* an algorithmic system and obeys its law *with infinite precision*, then nothing is won through the appearance of chaos-dynamical instabilities. No room for freedom is created – regardless of whether the law is deterministic or probabilistic. The contradiction persists.

¹²⁸ archive.org/download/philosophicaless00lapliala/philosophicaless00lapliala.pdf. (Translated by Frederick Wilson Truscott and Frederick Lincoln Emory.)

However the argument that has been carried out in the previous chapter is not affected by the above considerations. This means that Laplace's statement must be wrong regardless of whether there is quantum mechanical objective randomness or not, i.e. it must be wrong in another respect.

Thus the question is: *What* is wrong in Laplace's statement?

By assuming that an intelligence of sufficient capacity would be able to derive the future from the present, Laplace postulates – I quote my formulation in 2.2 – that there is "an *algorithm*, that is: a procedure, which permits deriving and calculating future events from the present conditions through the application of defined rules."

But as stated at the beginning of the derivation of free will, already in the case of more than three moving bodies bound to each other by gravitation, it is impossible to specify an *exact* method, because ***such a method does not exist.***

In order to predict the future, however, the method *must* be exact. (Moreover, since nature itself is infinitely precise, only an exact method would be entitled to claim correspondence to the algorithm that nature itself performs.)

Of course one can set up differential equations and plug in initial conditions, but it is impossible to integrate these equations. However analytic integration is the only exact method, i.e. the only one that leads to correct values of variables at a future point in time. Otherwise, there are only approximations, whose results can be wrong in the next moment.

Therefore, without integration, one comes not beyond the present; determining the future fails.

Let us look at the function that represents the path of one of the bodies. Since the movement of each body depends on all other bodies, and because their positions and momentums are altered incessantly, from this function follows actually *nothing at all*. There is no possibility for any precise prediction of the future position of the body. And the same applies of course to all other bodies.

In the general case, there is no exact algorithm that leads from the present to the future, and that means at the same time: there is no method that corresponds to that which nature itself uses to create the future.

How is it then possible that the illusion that such an algorithm exists, could become so powerful? Are there any cases at all, in which it exists?

Yes, there are such ones, even if only as idealizations. It is the cases that lie so to speak at maximum distance from the general case, namely those cases where not all objects move freely and random but where only *one single object* moves and *all other objects* (insofar they influence the body to be measured) are assumed as resting.

Exactly such idealized special cases, however, are the ones through which physical laws can be discovered and tested – and this applies from Galileo's simple pendulums and rolling balls up to the most complex measurements in modern particle accelerators. This is the reason why these laboratory experiments have become paradigms, and in this way the illusion could emerge that the future develops from the present in an algorithmic way

In short: The law can only turn into an algorithm, if *order* is presupposed.

In the general case, however – and this is the one where, except for the order which is already given by the law itself, no further order exists, i.e. in which the initial conditions are random – there is a law, but there is no algorithm.

Now I change over to my own physical system. Here, the just described situation is immediately recognizable. The law that generates reality is

$$\frac{d\sigma}{dr} = \pm \frac{1}{c^2} \frac{dv}{dt}$$

Thus, two differential quotients are related to each other.

One could say: *reality is woven in the infinite Small, or: the meshes of the fabric of reality are infinitely small.*

Here, it is obvious that, in order to overcome the restriction – whether in space or in time – to the infinite Small, it *must* be integrated. At the same time, however, it is evident that it *cannot* be integrated as long as there is no *further information*, that is: *global information*.

For example, consider the description of gravitation in the spherically symmetric case in the Second Part. Here, it has been assumed that $\sigma = \frac{r - m}{r}$ – which means that there is a highly ordered, stationary state (σ is time-independent).

Under this condition, also v can be determined by integration, and statements about a finite spatial area can be derived. They result in the *law of gravitation* (in the spherically symmetric case).

In the general, unordered case, however, the fabric of reality would be represented in the description as *uncountable set* of facts – namely the values of the two variables σ and v (or σ und ζ) at any position of the continuum – which, though they are related to each other by the law, cannot be composed into an algorithm in any way.

Therefore, Laplace was wrong. No matter how powerful the intelligence is that looks at nature – it is impossible for it to deduce the future from the present, because *there is no method* by which this goal could be reached – not even if what happens is determined everywhere and anytime by the law.

As regards the description of reality, we have achieved the desired result. Even if the assumption were permitted that the information that is contained in nature itself could *completely* be transferred to a system of equations¹²⁹, it would not be possible to compress this system of equations to a (finite) algorithm, and the derivation of the future from the present would fail. Thus, the assertion: "The future *follows* from the present" is wrong.

Therefore also the statement: "Everything which happens follows from laws and initial conditions" is invalid, which previously was called the *Completeness Axiom of Science* – and it was exactly this statement that stood in the way of the assumption of free will.

4.3. Why Nature is not an algorithmic System

Nevertheless, the situation is not entirely satisfactory. Due to the fact that in the reality at any point and at any time is determined what happens by a law, the suspicion could germinate that the previously derived result is merely a shortcoming of the description and does not concern nature itself.

Does not this very fact testify that *nature itself* is yet an algorithmic system, in other words: that the future is produced in an algorithmic way?

As starting point of the explanation why this is not the case serves the difference between reality and description, which already has been mentioned several times: any existing object is always *active by*

¹²⁹ This assumption itself, however, already represents an inadmissible idealization, because an uncountable set of facts cannot be contained in a system of equations, not even in an *infinite* one.

itself; in contrast, objects that belong to a description – or to a model, or a simulation – of reality, are lacking this activity; *by themselves*, they are *passive*.

An example: Let us look at the system *sun, earth and moon*. In the reality, earth and moon are moving *by themselves* – gravitation, which causes their motion, is inseparably bound to their existence.

But if a model of this system is made, then it is necessary to install a mechanism that mimics the movement of earth and moon, and to provide it with energy. *By themselves*, the elements of the model do nothing at all – they just stay in place.

The same applies to a description: one can set up an equation, from which the movement of earth and moon can be calculated in any desired approximation, however the future of the system reveals itself only if the calculation is actually carried out; *by itself*, nothing happens.

With the aid of this simple metaphysical distinction can be understood why *a description system* needs an algorithm to deduce the future, and why *nature itself* in contrast does *not* need an algorithm. As follows:

We stick to the assumption that anywhere and anytime the law *acts*. I emphasized the word "acts", because it contains the explanation why reality – in contrast to a description of reality – need not be an algorithmic system in order to generate the future.

Precisely because the essence of reality is *activity*, the assumption that *now* – at the present moment – at each point of the continuum is determined what happens, is not only a necessary but also a sufficient condition for the development of the future from the present. For the reality, it is sufficient that it "knows" *now* and *at any position* how it has to act. It need not step out of the infinite Small and know the uncountable infinitely many relationships between the points of the continuum. If it acts everywhere in the infinite Small according to its law, then it proceeds *by itself* – even without this knowledge – from the present to the future.

But in a description-system of reality, this is not the case. Even if the system could contain all the information about what happens in the reality at a given time at any position, this would not be sufficient for the generation of the future, because these facts lack the crucial feature: *activity*. The system is passive, nothing happens *by itself*, the future does *not* develop.

Therefore, in the description the mere information, what at the present moment happens at any position, is not sufficient for generating the future. The description-system needs an *algorithm* – a

calculation method – for determining the future, and this algorithm must of course contain a procedure by which the restriction to infinitely small space- and time-intervals is abolished.

By this comparison is demonstrated that the *algorithm of the description* takes over the task of the *activity of the reality*. In the reality, the future is generated by *activity*, in the description, an *algorithm* is needed.

Reality, due to its activity, can produce the future solely from the information about the spatial and temporal conditions in differential intervals – which means: without having to leave the infinite Small.

But in the description, if one aims to proceed from the present into the future, one has to know *already now* the relationships between the positions and time points, which are spatially and temporally separated from each other. Expressed mathematically, these relationships must be integrable functions,¹³⁰ which however in general is not the case.

In addition, the continuum exists only *as changing*, and this means that all functional dependencies are changing permanently. Time and space changes are inextricably intertwined. What is valid *now*, can be wrong in the next instant. Thus in the general case, integration is impossible. So, one remains trapped in the infinite Small, and this means: one does not reach beyond the present.

In short:

In order to proceed from the present to the future, we need to integrate, but nature does not need to integrate .

Thus it is the difference between the essence of description and reality from which the explanation follows why reality must not be identified with an algorithmic system.

From this fact, a series of restrictions ensues regarding the applicability of notions to reality.

However it is not easy to understand these restrictions, because *all* our notions are elements of descriptions, such that we are always subjected to the temptation to equate description and reality – and this applies in particular in the field of science.

¹³⁰ By "integrable" is meant: the primitive exists, and the definite integral can be calculated.

So we have to leave the implicitness of our conceptual network – the meanings of the terms and their interconnections – and expose ourselves to the alienation that comes with the attempt to transfer concepts from description to reality.¹³¹

The restriction regarding the term "follows from", which appears in the Completeness Axiom, has already been mentioned: Since nature is not an algorithmic system, it cannot be asserted that the future *follows* from the present. Only the statement is permissible that the future *evolves* from the present.

The same applies to the concept "predetermined". Claiming that the future is determined implies that the future can be derived from the present. This would mean that the future is contained in the present – that, in this sense, it exists already. But this is not the case.

Here is a more detailed explanation to this question:

Let's start with an example: Suppose we have the intention to weave a multicolored carpet. The initial series of meshes lies already before us, and we also have a complete set of weaving-rules. Let us now assume that, at some point during the course of the weaving process, on the carpet the image of a lion arises.

The question is: did this lion already exist before the carpet was woven? If this means that the lion can be produced by the initial series of meshes and the weaving-rules – that, in this sense, it is thus contained in them – then the answer is *yes*.

Mathematicians are confronted with a question of the same kind, when they encounter mathematical theorems during the course of their conclusions. These theorems are obviously not invented but discovered. They are in the same way "contained" in the axioms and rules of the mathematical system as the lion is contained in the initial series of meshes and the weaving-rules of the carpet system.

Let us now turn back to our question: is the future contained in the present?

The decisive difference between the reality on the one side and the carpet-system or the mathematical system on the other side is the fact that in the carpet system and in the mathematical system a *procedure* exists, by which the entity whose existence is the subject of our discussion can be

¹³¹ Since we are *always* caught in the description, it may seem strange to contrast reality and description with each other. However this comparison is justified, because at the limit of describability contradictions occur from which not only follows that description and reality do not coincide but also *how* they differ. The building-up of physics, which has been presented in the Second Part, is based upon conclusions of this kind.

fabricated. In the case of the carpet, this procedure is the weaving in accordance with the rules, in the mathematical system, the method which leads to the discovery of the proposition is drawing correct inferences.

But in the case of the reality, there is no procedure that leads us from the present to the future. There is no path to the future besides the one that reality itself takes. Thus the only possibility, to obtain precise information about the future, is to wait until it occurs.

To say it again in the same way as just before:

Even if a description system existed, which would contain all information about what happens at a given point in time at any position of reality, this would not be sufficient for the generation of the future in this system.

Since the system provides no algorithm for the fabrication of the future, the future is not part of this system – it *does not exist* therein.

And finally: even if it were possible in some magic manner to add to the system the metaphysical quality *activity* that reality possesses, then the future would still not be *contained* in the system – it would just *evolve* from it.

So we have come to the conclusion: ***The future is not contained in the present. It does not exist before it occurs.***

Reality is not an algorithmic system.

This statement is more general than that which was necessary to permit freedom of will:

The statement that was necessary for the existence of freedom was: *Mental states cannot be derived from any given system of initial conditions and equations.*

But that reality is not an algorithmic system means:

No state of any area of reality can be derived completely from any given system of initial conditions and equations.¹³²

¹³² Why, then, exist algorithmic principles at all? This question will be answered in the following sections.

So, in the description of reality, there are only approximations, probability statements and qualitative predictions for reasons *of principle*.

On a readily accessible level of analysis, this appears self-evident. Neither can we measure infinitely accurate, nor encode infinitely exact numbers, nor execute an algorithm with infinite precision.

However all these obvious limitations concern only *descriptions*, and their existence contributes nothing to the elucidation of the question of whether an algorithm *exists*, that is to say: whether *reality itself* performs such an algorithm; In this case, freedom of will would disappear despite the just mentioned restrictions that apply to all descriptions.

The real answer to why there are only approximations lies deeper: it is founded in the fact that reality needs no algorithm. For the development of the future, the differential weaving-rule is sufficient. But this rule is not an algorithm – it can only turn into an algorithm (within a description) in connection with idealized assumptions of additional order.

However if in the reality no algorithm exists, then there is of course no possibility to represent it in the description, and *this* is the reason why any description is just an approximation.

I shall go back to the crucial point of the whole analysis. It is the statement: *The future is not contained in the present. It does not exist, before it occurs.*

Ultimately, only because of this fact it is possible to claim that the will is free. Exactly because a decision *does not exist* before the decision-making process has taken place, it depends on the decision-making process itself and not on any previous state of the neuronal network.

But if reality were determined, then the future – and thus also the volitional decision – would already be given before it occurs. There would be an algorithm that permitted the calculation of the future from the present – precisely the one that nature would perform for generating the future, if it were deterministic – and any decision could be derived from past conditions. (I again emphasize: it is irrelevant that such an algorithm could never be available – the mere assumption of its existence, which would be inevitable in a deterministic view of nature, is sufficient to rule out free will.)

If there is no algorithm, however, then the future does not follow from the past, and then it is not possible, to regard a volitional decision as a result of a previous neuronal or physical state, or of a state defined in any other way. To the question of why a person has decided so and not otherwise, there is then only one permissible answer:

Because he/she wanted it this way.

Note:

Of course this does not mean that volitional decisions cannot be analyzed with respect to their (neuronal, chemical, physical, genetic, social etc.) causes. It means, however, that these analyses necessarily remain incomplete and never lead to a secure result, because mental phenomena cannot be reduced to other layers of reality. The will remains the last authority.

Proposition

Let determinism be the thesis that there is at any instant exactly one future ¹³³. Let indeterminism be the thesis that there is at any instant more than one future. Then the following applies:

The future does not exist before it occurs. Thus there is no time-point where one or more than one future exists. Reality is neither deterministic nor indeterministic.

The alternative deterministic or indeterministic applies only to descriptions, not to reality itself. ¹³⁴

From the scientific view, although reality is not in any case calculable, it is in any case *mappable* to a mathematical scenario. In scientific experiments, the conviction is confirmed that nature behaves according to laws.

From our point of view, both assumptions are wrong.

Uncountable sets, which do not exhibit a mathematically describable order, are not mappable. The *general case*, however, is defined as such a set.

¹³³ According to Peter van Inwagen: *An essay on free will*, 2nd edition, Clarendon Press, Oxford 1986, p. 3.

¹³⁴ Actually, Inwagen defines determinism as the "thesis that there is at any instant exactly one *physically possible* future." However since the concept of "physical possibility" applies only to descriptions and not to the reality itself, the question "determinism or indeterminism" turns into a formal problem. The answer is then: Since there is no algorithm that leads from the present to the future, the question of whether there exists exactly one or more than one future cannot be answered. Thus, from a formal point of view, determinism and indeterminism are *undecidable* hypotheses.

But in the formal view gets lost what *actually* should be said, namely the fundamental metaphysical insight that neither of the two hypotheses is true – or rather, that none can be applied to reality.

Moreover, as described before, it is impossible to map the *activity* of reality. That, what promotes reality, can only be mathematically emulated by an algorithm. The existence of an algorithm, however, presupposes a degree of order which exists only in idealized cases. Every real case, however, corresponds to an uncountable set of facts, and, as such, it is not completely describable.

The second wrong assumption is that nature behaves according to laws. Though this assumption is confirmed in some areas of nature in almost unbelievable approximation, it is nonetheless metaphysically wrong:

Reality is not a system of laws. The *only exact law* is the fundamental law (1). All other laws, also the so-called natural laws, *develop* only in the course of the evolution of nature. And since they are not about unchangeable entities but about attractors – which means: about dynamic states that are *never* completely identical –, they do never apply completely accurately.

Basically, the question of whether laws exist is of the same kind as the question of whether circles exist. In the reality, there are no circles. Each real circle is an approximation. The non-existence of circles is not a matter of probability, but a *metaphysical certainty*. Circles are elements of descriptions, not elements of reality.¹³⁵

If reality as a whole were a mathematical or a formal system S, then states of physical systems would be *statements* in S. With respect to any future state could then be asked if it is derivable in S.

However any S contains a fixed set of rules or laws from which all other laws can be derived, whereas in the reality new non-derivable laws evolve. It is the non-mappable metaphysical quality *activity*, which causes this evolution.

From this follows that reality cannot be understood as a system S. If it would be identified with such a system, then it would permanently generate states that correspond to *undecidable statements* of the system, that is: statements that cannot be derived in S.

The only thing that can be said is that identical circumstances have identical consequences. Usually, this is seen as criterion for determinacy, because it means that there are no bifurcations in the evolution of reality – in other words: if there were another universe whose present is completely identical with that of our universe, then also the future of this second universe would be completely identical with that of our universe.

¹³⁵ All issues that have just been touched on will be discussed later in detail.

Therefrom is then further concluded that nobody would ever be able to "decide otherwise", because in any case the outcome has been "determined" already before.

From the foregoing, however, it is clear that this conclusion is invalid. Here, "being determined from" has the same meaning as "being contained in", and since the future is generally not contained in the present, it cannot be claimed that a decision is determined already before.

This assumption would only be possible if reality were understood as a system S; but then the result of the decision would correspond to an undecidable statement of S, and the claim of an already given "determination" could not be maintained.¹³⁶

Van Inwagen's formulation "There is only one possible future" must therefore be replaced by the weaker statement "Only one future is possible".

The difference to van Inwagen's formulation is that the new formulation does not refer to a *specific* future; e.g. when it is asked whether a specific decision will be made, then this is an unanswerable question,

Is this decision thus a *possible* decision? No, this assertion would be incorrect too. The correct answer is that also the question, whether it is a possible decision or not, is undecidable.

¹³⁶ The assumption of another universe which is identical with our universe is inadmissible, even as gedanken experiment, because it includes the wrong presupposition that it were possible (of course only *in principle*) to reproduce the reality, which means: to transfer all the information that is contained in our universe to another universe. This, however, is impossible; as already mentioned: even if infinitely many equations of infinite length were permitted – they could still not contain an uncountable set of facts.

4.4. *Causality top-down*

The assumption, that everything is determined at the elementary layer of reality, has dissolved, the stranglehold on mind has come off.

Nevertheless, the conclusions of the last two sections – despite the elimination of the contradiction between freedom and determinism – would have no effect, unless they are supplemented by the principle of *causality top-down*.

What is causality top-down? First I will explain it again with reference to the examples I've used in the previous chapter.

Let us first consider a jar made of glass. It is struck and vibrates. Let us take out any molecule. What determines the oscillation state of the molecule?

Obviously not its local environment, but the *form of the entire jar*. It is the form that structures the state space and defines in this way the dynamics of the jar and of all its components. The constant form, which is preserved over time, becomes the basis of a law: the oscillation law of the jar.

In short: *The whole – the jar – determines the movement of the parts (the molecules)*.

The same is true for a *neuron*. Here, however, not only the outward form, but also the internal (physicochemical) *structure* is important: the state space of the neuron is structured by the external form and the internal structure of the neuron. Together, they determine where and in what manner electrical potentials are generated, transported, and finally converted into chemical signals and passed to other neurons.

Here, too, the state dynamics of the neuron is determined by form and structure. In a strictly local view, it would be impossible to predict the activity of a molecule or atom. And also here, constant form and structure of the neuron provide for the occurrence of a law: the neuronal input-output-law.

Also in this case applies: *The whole – the neuron – determines the actions of its elements*.

As final example, we choose mental states. They are global activation patterns of neuronal networks which however, as outlined in the previous chapter, are not determined by the neuronal input-output-law and the architecture of the neuronal network – those neuronal activities, that occur in functionally unbound (associative) areas due to these two conditions, can be regarded, in our context, as entirely by

chance – but are impressed on the network through external conditions (by real objects and processes), such that the patterns can become representations of the objects.

Mental states structure in this way the state space of the network, and the sequence of mental states determines the dynamics of the network. The process is again regular: it follows the respective (individual) mental law, which is based on the (approximate) constancy of mental states – understood as global states of the network – and the transitions between them.

Again, it can be asserted: *The whole – the mental processes, understood as global phenomena of the neuronal network, which represent attractors in the state space of the network – determines the dynamics of the network and of its elements.*

What is true for these examples is also true in general: form and structure of an entity determine its dynamics. The direction of causality is not "bottom-up", but "top-down", or, in other words, the dynamics of an entity depends not (only) on its components and their interactions, but (also) on its form and structure; they are the ones who determine the structure of the state space of the entity and make the selection of possible trajectories.

Here, it is of crucial importance that reality is not an algorithmic system. For if it were, then the causality "bottom-up" would be *complete* and there would be no room for the causality "top-down". It would be enough *once* to enter the correct initial conditions into the fundamental law-mechanism, and then the mechanism would continue for eternity.

Causality top-down would then be no independent phenomenon; each description on a higher layer of being would be nothing more than a simplified representation or summary of facts that follow from the circumstances on the respective deeper layer of being. With this, however, everything would ultimately follow from the deepest layer, and all other layers of being would have lost their self-dependence.

This can be illustrated by the following simple example: The operation $2+2=4$ on a pocket calculator can be described in two ways: on the entry level – as a series of 4 keystrokes – or on the electronic level. In this case, however, it is clear that the causal relationships are to be sought in the logic circuits of the electronic level and not in the key strokes. The result 4 is related with the input keystrokes only via the circuits. Thus the level of the keystrokes is not a self-dependent layer of reality, and the description of the process by the sequence of keystrokes is just a simplified representation that does not contain the causal relations.

If reality were an algorithmic system, then the circumstances would be in all cases equal to those of the pocket calculator. Thus the proof that reality is not an algorithmic system is necessary for the existence of self-dependent, hierarchically higher layers of being.

The thought train, by which this self-dependence can be substantiated and which ultimately leads up to the freedom of will, can be outlined – including the statements of this chapter – in the following way: It begins with the division of the scientific description of reality in *equations* and *initial conditions*, i.e. in mathematical relationships between variables and the values of these variables at a given time.

Due to the assumption that the world consists of a finite number of elementary interacting entities, current physics encourages the idea that initial conditions are the values of the attributes of such entities, and global circumstances can be acquired algorithmically. Though, as demonstrated previously, the assumption of calculability of nature is wrong even under the condition of the existence of elementary entities, still the full significance of the two elements of the description – initial conditions and laws – becomes only clear when viewed from their logical and metaphysical presuppositions, from which in the Second Part the development of reality has been reconstructed.

Here, the deepest layer of reality is *alteration of AGENT*. By determining AGENT as the set of necessary and sufficient conditions of existence, this layer turns into an ever-changing spacetime continuum, which exists only in the form of this change and whose only rule is that the differential alteration of the metric density of space is equal to the differential alteration of the metric density of time.

Thus, in the *origin of everything* there is only one single law, and this law acts in the infinite Small. In general, from this law cannot be derived any algorithm, not even in connection with initial conditions, because these initial conditions vanish into infinity. It would be nonsensical to denote the uncountable many values of σ and ζ as initial conditions. Instead they must be seen as *varying global state*, whose essential characteristics is that its spatial and temporal relations cannot be captured algorithmically – not without the assumption of additional order. Because of this fact, the statement: "The future follows from the present" becomes wrong. The future global state is not derivable.

Therefore, the second element of the description, which is no longer called "initial conditions" but "global state", obtains an *essential independence* that it does not possess in the conventional view.

As has been shown, exactly this independence of the global state is the basis for the proof of the self-dependence of complex being. That, which appears as *form and structure* of being, is indeed nothing other than this very global state: from the conditions which, in the general case, are random and not ascertainable, develop – due to the self-organization of nature – form and structure of being, and this

means: *causality top-down* evolves. Thus the development of being is tantamount to the development of new laws, which determine the inside and outside dynamics of this being. In simple, idealized cases, the global state can be algorithmically compressed, that is to say: it can be brought into the form of solvable systems of equations.

What in standard-physics is seen as elementary layer of being, is – from the position taken here – the first and simplest layer of reality, which evolves from the *origin of everything*, and the so-called *natural laws* of standard-physics turn out to be laws of the kind that in the previous chapter were denoted as *laws of form* or *laws of structure*. (In the Second Part, this has been demonstrated for gravitation, electromagnetism and atomic regularities.)

However the evolution of nature progresses further: the simplest kinds of being unite to more complex entities, and again new laws evolve.

From this point of view, between nature and its description the following relationship exists:

1. No description system can reproduce reality exactly. It is *applicable* for the description of reality, if it contains the objects that occur in reality and represents their behavior in sufficient approximation.
2. Increasing complexity of nature means increasing complexity of description. If structures of higher complexity emerge, then the previously applicable description system must be replaced by a more complex one, which contains the previous one.

If there were a Theory of Everything, it would have to represent the ultimate system, that is: the one that encompasses all the previous systems. But in any case holds that – due to the appearance of mental states – there cannot be a description system that applies to nature *as a whole*, because mind lies outside of the area which can be described by given laws. However, since mind is part of nature, a Theory of Everything cannot exist.

4.5. On Order and Laws

This section contains some notes about the development of order and about dynamic laws.

About the emerging of order, however, I have to say nothing substantial. Nonetheless it seems imperative to me, to present at this point at least the bare essentials, so that they can take their rightful place in the argumentative context.

I avoid the difficulty to define order; for the purposes of the following discussion, it is sufficient to regard order as the generic term for the concepts form, structure, regularity, periodicity, etc.

After the foregoing, the following applies:

The scientific description of nature consists of *law* and *global state*. The law remains always the same. Therefore, the formation of order is always a change in the global state, which develops from random circumstances to ordered circumstances.

The emergence of being is tantamount to the formation of order and of laws of structure, by which this order is expressed. The emergence of more complex being entails additional, higher order and further, hierarchically higher laws of structure.

Now the most important question is undoubtedly: *How* does order develop?

Given the fact that neither the global state itself nor its temporal evolution can be captured algorithmically, it seems at first as if the emergence of order would escape any description.

But this is not true. In many cases it is possible, due to given boundary conditions, to gain information about the structure of the state space of a system – in particular about the attractors therein – and to draw conclusions whether the system will approach an ordered state.

Especially at the beginning of the self-development of nature – that is, where the conditions are most simple because they arise out of mere necessity – and at the (to our current knowledge) most complex (provisional) endpoint of this development it is possible to understand the emergence of order at least in principle.

The insight, how the universe organizes itself at the very beginning, follows – as described at the end of the Second Part – from the assumption that it is a closed metric structure of unchangeable size, which therefore will approach the simplest attractor: the state of standing waves.¹³⁷ (It must be taken into account, however, that this conclusion would only be correct if the universe were an ideal-elastic medium. Since it is a spacetime continuum, which has no absolute density, the circumstances are more complex, and the standing-wave-attractor is presumably only one of several organizing mechanisms.)

¹³⁷ To the unchangeable size of the universe see chapter 8. *Cosmology* in the Second Part. I don't know if the closeness of the metric structure follows from the fundamental law itself, in other words: if the closeness is the only boundary condition that is compatible with the law. I suppose so. Otherwise it would have to be assumed as an additional condition.

At the end of the development, where the order of the realm of mind commands, the emergence of order can again be understood through the assumption that mental states are attractors, which are impressed on the state space of the neuronal network by the perception of objects and events and their connections with inner information.

If the emergence of the mental order is seen in this way, then it corresponds quite naturally with our intuitive notion of the mind.

As chaos dynamics teaches, however, it can be extremely difficult to determine the attractors in the state space of a system and with it the self-organization of the system into organized patterns. Not before the 60s of the 20th century, this kind of processes has come into the view of natural science, and, after a period of media attention, it remains to this day – because of the great mathematical difficulties and the consequent slight chance of quick success – the little beloved stepchild of science, although it seems obvious that the question of the emergence of order would deserve at least the same attention as the currently prevailing investigation of processes that are governed by natural laws – or, from our point of view: by laws of structure.

Are the processes of self-organization not of this kind? No, they are not. The laws which they follow represent indeed a further type of laws that meets two criteria:

1. Self-organization presupposes non-linear feedback. Therefore, the equations are non-linear.
2. The equations contain variables that do not relate to the attributes of single localized entities – rather they are *global* variables, that is: variables that represent attributes of the system as a whole.

The second statement means that also in the laws of the generation of order – as in the laws of structure, in which an already existing order expresses itself – the global state determines the temporal evolution of the system.

In order to understand this as an *ontological* statement, also in this case the (previously demonstrated) independence (underivability) of the global state must be presupposed – otherwise the *global parameters* would be, as in the conventional view, only inaccurate summaries of local circumstances and not an autonomous element of the description.

To illustrate these circumstances, here an example: the first known chaotic system, the "Lorenz system" (named after its discoverer), which describes the dynamics of a viscous incompressible fluid between two plates, between which there is a temperature difference.

The system has 3 variables – let us call them X, Y, and Z – which are defined as follows: ¹³⁸

X is proportional to the absolute value of the convection speed.

Y is proportional to the temperature difference between ascending and descending flow.

Z is proportional to the deviation from the linear vertical temperature profile.

If the temperature difference ΔT of the two plates lies above a certain limit r_0 , then the System behaves chaotically, and in the state space the well-known *Lorenz-Attractor* emerges.

Since the Lorenz-System has only one attractor, for $\Delta T > r_0$ in any case – *independently of the initial conditions* – the system approaches the state, which is represented by the attractor.

Therefore, the behavior of the system is governed by *global parameters* – they determine the pattern which in the state space develops.

In this example, the following characteristics can be found, which are typical for the mathematical description of self-organization:

1. The system is to a certain extent independent of initial conditions of the type, which hitherto has been discussed, that is: from initial conditions in the form of values of variables that represent object-attributes or field quantities.
2. Therefore, not the behavior of the elements of the system is investigated – that would be impossible –, but the global long-term behavior, that is: the patterns which the system will approach. They are attractors of the state space. (For the pattern-formation, in particular chaotic attractors are relevant.)

Thus it is evident that the processes of self-organization represent another, new area of the description of nature, where the goal is not, as elsewhere in science, the most accurate and detailed determination of a future system state, but the attainment of *shape information*. ¹³⁹

¹³⁸ What follows is taken from a work of *Andreas Jung*, which can be found at <http://andreas.welcomes-you.com/research/talks/lorenz/>

The principle of self-organization fits in the following way into the here presented overview of the development of nature:

In the preceding sections of this chapter and in the previous chapter has been shown that, in the general case, the global conditions cannot be used to achieve an algorithm for calculating the temporal evolution of a system. Therefore, it remained unclear how this evolution could be understood.

Here, self-organization by feedback is the necessary complement: If a description by an algorithm, which involves variables that correspond to the attributes of individual objects, is impossible – which applies to the general case, because there such an algorithm simply does not exist – then the analysis of the global conditions takes its place, and the description is performed by means of variables which represent global attributes.

4.6. Some Consequences

The Independence of global Parameters

Though the description of chaotic feedback systems can be deterministic – as e.g. in the Lorenz system –, according to the analyses of the sections 4.2 and 4.3 it would be inadmissible, to infer from the determinism of the description the determinism of the system itself.

I outline the reasoning again:

In a linear system, as would be for example in sufficient approximation a large amount of gas molecules in a closed container, there is – at least in principle – an algorithm through which from the positions and momentums of the molecules the development of the system could be determined.

Of course, given a number of, say 10^{26} molecules, it would be completely absurd to actually try this type of description, but there is nothing against the assumption of the existence of such an algorithm. Therefore, this (idealized) system is deterministic.

In contrast, in a non-linear feedback system such an algorithm does not exist *on principle*. This has been demonstrated in 4.2 and 4.3 for continuous self-organizing systems. But it applies also to systems

¹³⁹ However, in many chaotic systems (e.g. the weather) the patterns are only perceptible in the state space. In the reality, they remain hidden because they lack exactly that, what is the necessary condition of *being*: the *form* that exists in the real 3-dimensional space and is conserved over a certain time period.

that consist of a finite number of bodies that interact with each other, e.g. a system of a large number of gravitating bodies.

What does it mean, then, that the equations, by which a self-organizing system is described, are deterministic? The answer is as follows:

The deterministic equations do not contain all details of the system state. They do not refer to attributes of the single elements of the system, but to global attributes, that is: such of the whole system. The details are ignored.

Thus, it is a "qualitative determinism". Two systems can satisfy the same chaos-dynamical equations, although they differ in the details. They would approach the same attractor, but they would nonetheless be distinguishable.

Local differences remain excluded from this "qualitative deterministic" description, and, therefore, from the fact that the equations of chaos dynamics are deterministic cannot be inferred the determinism of the systems described by them.

One is thus faced again with the *independence of the global state* – and here, this is equivalent to the independence of the *description by global parameters*.

Therefore, such a description cannot be understood merely as an inaccurate summary of local deterministic occurrences. It is independent of these and thus represents a *fundamental level* of description – in the sense that it can *not* be reduced to equations of motion that apply to the single elements of the system, because such equations simply *do not exist*. And this is the real reason that the principles of the description must change, in other words: that one has to switch from the local description to the global analysis of morphogenesis.

All of this is also true in the conventional approach. However, the circumstances will only be completely clear when viewed from the build-up of physics presented here:

Here, there is not a layer of elementary entities, which everything consists of and whose dynamics determines everything. Instead there is a continuum and its differential law. But from this law alone follows *nothing*. In any case the *global circumstances* are required. This means: here, law and (variable) boundary conditions – i.e. *law and global state* – are equivalent. They exist only together. There is always causality bottom-up and top-down at the same time.

The validity of the deterministic equations of chaos dynamics, which contain global parameters, proves that in self-organizing feedback systems indeed the *global state* takes the lead and determines the development of the system.

Objects; Object-Attributes and Interactions

Let us assume that an area of the spacetime continuum has evolved due to certain boundary conditions from a disordered to an ordered state, and there had thus a pattern emerged that manifests itself not only in a state space, but also in the real three-dimensional space. Let us further assume, this pattern remained virtually unchanged over a certain period of time (this can be a billionth of a second or also 100 billion years).

Then *being* has emerged – an object that has form and structure and displays certain attributes.

However it is not *elementary* (in the sense of substantially indivisible and structureless), but a *dynamic pattern*, and therefore its attributes are nothing other than *global parameters*.

While the description of the formation of being requires the use of time-varying global parameters, the entity itself – that is: what appears as (approximately) stationary final product of this formation process – must be described by (approximately) constant global parameters, and these are then obviously the attributes of this being. Examples are *electrical charge* or *mass*, or the properties of states of the so-called *electron shells* of atoms

They serve then as variables in *laws of structure* that describe the interactions between objects with these attributes: electromagnetism, gravity, atomic and molecular dynamics.

With this, the layer of reality is reached that in standard physics is considered elementary.

At this level of simple physical objects and their interactions we meet again the phenomenon, which previously has been determined as essential ontological feature of the dynamics of the fundamental layer (the spacetime continuum that is the precondition of every being). As the continuum itself, also the systems which consist of such simple objects and to which the laws of structure apply that emerged together with these objects, are only then algorithmic systems, if they contain *more* order than that which is given through the laws alone. If this is not the case, then the development of the system depends again on global parameters (of higher order), and, under appropriate boundary conditions again new, more complex objects can emerge, with new attributes and new interactions etc.

How often this step by step upwards moving development can repeat itself depends on the respective conditions. The only system that we currently know, which permits an evolutionary ascent over several stages up to being of remarkably high complexity, is the biosphere of the earth.

The Direction of Time as a fundamental Fact

Due to the considerations of the last sections, the question about the direction of time presents itself in a new form.

The mathematical expression for the process that generates the reality is $\frac{d\sigma}{dr} = \pm \frac{1}{c^2} \frac{dv}{dt}$.

Thus it is a *differential* process, and from this follows that statements, which should correspond to states of reality, would have to comprise an uncountably infinite set of facts and could not be compressed to finite statements.¹⁴⁰ But this means that states of reality cannot be completely mapped by any mathematical system.

From this follows that all mathematical concepts, which the description of reality has hitherto been based upon, have only the status of approximations. This applies e.g. also to the Hamiltonian Formalism, which generally serves as basis for the prove of time reversibility. Even the phase space concept itself is involved – there is no phase space with uncountably many dimensions – and is thus only suited for approximately valid or qualitative statements. (In the following, I will use it in this sense.)

Therefore, the assertion: "Time reversal is possible" or: "In the phase space of a system also the reversed trajectory exists" must be weakened to the assertion: "Time reversal is approximately possible" or: "In the phase space of a system trajectories exist which approximately conform with reversed trajectories".

Also this weaker assertion, however, is only true for systems in which the time evolution can be expressed through equations of motion of the components of the system – a typical example would be a system with a great number of gas molecules in a closed container –, but it is completely wrong when applied to systems which evolve to an ordered state or maintain such a state. As elucidated above, this kind of systems is not governed by laws of motion of elementary objects – such objects no longer exist, as the points of the continuum are not "objects" –, but by equations, through which the time evolution is expressed by global parameters: the non-linear feedback equations of chaos

¹⁴⁰ Presumably applies that they even could not be compressed to countably infinite statements.

dynamics. Time symmetry, however, means reversing the movement direction of *all* components of a system. But since the local regularities of the point-movements obey the global laws, such a reversal is obviously impossible, and this means: the time-reversed development is ruled out.

Therefore, the direction of time is no longer a question of probability: except for idealized special cases, time-symmetry is impossible for reasons of principle, that is: for metaphysical reasons.¹⁴¹

(Further below, in Subsection "[Addition: Proof of the Impossibility of Time Reversal](#)", I will show that the assertion of time reversibility can also be refuted by another argument.)

Being as Attractor

Everything that exists is a pattern of changes of the spacetime continuum. Since every being conserves its form over a certain time period, it must correspond to an *attractor* of the continuum dynamics – and this applies to *every* being, from elementary objects up to mental states. With this, it is clear at the same time that being is never identical with itself at different time points. This can be demonstrated as follows:

There are three types of attractors: fixed points, cyclic orbits and chaotic attractors. Fixed points correspond to static states. In a reality that exists only as changing, such states are impossible. Therefore, our choice is restricted to cyclic and chaotic attractors.¹⁴²

Does being correspond to chaotic or to cyclic attractors? Presumably there are both variants. If, as in quantum mechanics, the possible states of objects and systems form discrete sequences, then they are comparable to standing waves and correspond therefore to cyclic attractors. In this case, in the representation of states and transitions between them the fundamental non-linearity of the real, causal events can be neglected (as is done in quantum mechanics).

¹⁴¹ Ilya Prigogine is known for his intention to derive the direction of the time from the laws of self-organization. But I think that this project is doomed to failure, if not at the same time the assumption is refuted that there are fundamental equations of motion, which contain the dynamics of the elementary components of a system and thereby determine the entire system. It is basically the same facts as in the case of Free Will: The dominance of the Global over the Local can only be asserted if there is no fundamental layer of reality by which the future is generated in an algorithmic way.

¹⁴² In addition, there may be steady states in the form of singularities, as in the case of black holes, where a spherically symmetric, temporally constant metric flow into the center exists.

However states, which correspond to standing waves, are never completely identical with each other. As an illustration, consider again an acoustic scenario for comparison: If two buglers blow the same tone, then the probability that the oscillation states in both instruments are identical is nonetheless equal to zero. The same applies to the oscillation states in the same instrument at two different points in time.

And the same applies also to standing wave states of quantum mechanical systems – and precisely this fact is the reason why for the time points of the transitions between such states only probabilities can be predicted.¹⁴³ ¹⁴⁴ Therefore, in the case that a being corresponds to a cyclic attractor, precisely applies what was initially claimed: It is never exactly the same. This also implies: Two objects of the same type are never completely identical.

Let us now consider the second option. If a being does not correspond to a cyclical but to a chaotic attractor, then the claim follows from the definition of the chaotic attractor: The trajectory never goes twice through the same point, and this means that there is no being that has a completely identical shape at two different time points. And also in this case applies that two objects of the same type are never completely identical.

Are there any objects that correspond to chaotic attractors? Probably yes. The non-linearity of the occurrences within the atomic nuclei suggests that nuclei are such objects. *Mental states* could also be chaotic attractors.

The fact that being never stays identical with itself has the consequence that laws, which contain variables that relate to attributes of being, can ultimately only be *probability laws*, or, if they are not formulated as such – as e.g. in the case of the theory of general relativity – their predictions cannot be completely precise. Complete accuracy would only be achievable if one could penetrate to the deepest level of reality – to the level where reality coincides exactly with the fundamental law. But this is

¹⁴³ Unfortunately, currently prevails the interpretive misunderstanding, they were "objective" probabilities. But actually they are "normal" probabilities whose occurrence can be explained through the existence of a deeper layer – the layer of pattern-formation by feedback and of the continuum flows and waves that cause these patterns and reversely are also structured by them.

¹⁴⁴ Due to its structure in the form of standing waves, the area of atoms and molecules is that realm of reality which comes closest to algorithmic describability. But even if the fundamental non-linearity here seems completely dispelled, this is ultimately an illusion. The restlessness of the continuous background – even if it remains immeasurable – and the inevitable disturbances from outside prevent that any quantum mechanical system can ever reach a dynamic equilibrium and would then be fully linearized.

impossible, because there one would again arrive at the uncountably many values of the two variables σ and v .

The question arises, to what extent it will ever be possible to describe the non-linear processes that ultimately are the prerequisite for the emergence and transformation of being. Undoubtedly, such a description would be much more complicated than the simple assumption that the simplest forms of being are not dynamic patterns, but fundamental, substantial entities.

After all, it should be noted that the current gain in simplicity is bought at the price that, due to false basic assumptions, those processes where the fundamental non-linearity becomes apparent – and such processes exist with certainty – can only be described by formalisms which, though they are indeed quantitative approximations to reality, miss reality completely as regards its actual structure.¹⁴⁵ The hypothesis of elementary entities makes the way to the actual structure of reality completely inaccessible.

But even if the difficulties of non-linear description should prove to be insurmountable: As has been shown in the first part, a significant progress of understanding is already achieved by correcting only the interpretation. Reality opens up to the conceptualizations that are at our disposal, and the absurdities of the contemporary interpretation disappear.

The three Types of dynamical Laws

There are three types of laws that govern the dynamics of systems:

a) A differential law that acts in the infinite Small. It is the fundamental law. The fabric of reality is woven by it. In this sense, it is *THE Law of nature or the universal formula*.

In the general case, the global state cannot be compressed into an algorithm. Exact predictions about finite spatial areas are impossible.

b) The laws of the formation of order. They contain feedback and are non-linear. Their variables correspond to global system attributes.

¹⁴⁵ As already mentioned in the second part, I think that the processes of the so-called strong interaction are of this kind.

The reason for the use of global variables is not the lack of knowledge of the local conditions – even their complete knowledge would not be sufficient to determine the temporal development of the system¹⁴⁶ – but the fact that in self-organizing systems the temporal evolution, that is: the shape formation, is determined by the *global state* and can therefore only be captured by a description through global parameters.

c) Laws of structure.

They exist due to an already existing order. They permit to describe the dynamics of entities and their interactions, which are elements of a higher layer of reality, which means that they have emerged by laws of the second type. All known interaction laws are laws of structure.

All laws of structure are probability laws. If they are not formulated as such, they are not completely exact.

Possible Weakenings of the Conditions; the Issue of Discretization

For the proof that the global state is an independent element of the description – which in turn is a necessary prerequisite of the independence of mind and free will – the basic assumptions of my physical system have been used:

Space and time are continuous; the law that generates reality is differential. Reality is a differential fabric of spacetime alterations.

Noting that the current physics assumes a fundamental quantization, the question is of interest, how far these conditions can be weakened, without the results being lost.

If space and time were discrete, then the universe would be a finite algorithmic system, and everything would be determined.

¹⁴⁶ In the case of the simplest forms of being – those ones which emerge through the self-organization of the continuum – this assertion is evident, because here the totality of the local conditions is an uncountable set. However also in the case of self-organizing processes, where not the continuum but a large number of objects organizes itself into patterns, the existence of an algorithm for calculating future states of the system is ruled out due to feedback. Consider again the example of numerous bodies which are gravitationally bound to each other.

So at least must be assumed that either space is continuous or time. However, they cannot be separated from each other: If one of them is discrete, then also the other. It is therefore necessary that both are continuous.

The simple example of a system of many bodies that are bound together by Newtonian gravitation shows already that, even in this view, no algorithm exists that leads from the present into the future.

So even such a universe is not determined, and therefore all conclusions remain correct, which have been performed here.

This applies also to the case where all interactions are quantized, and where all beings can occupy only a discrete sequence of states: Also here, the assumption of continuity of space is sufficient, because from it follows that there are infinitely many possible positions in space for any being, which again rules out the existence of an algorithm.

However, based on such assumptions it would hardly be possible to formulate and understand the difference between reality and description.

Additions

1. Equation (1) is linear. Why then can self-organization of the continuum by non-linear feedback occur?

The first reason is that the transition from the infinite Small to the Finite is at the same time a transition from the Linear to the Non-linear.

For example, consider waves. Waves are actually *always* non-linear – a fact which in practice may be neglected because either the amplitudes are small compared to the wavelengths, or because the waves behave just due to nonlinear feedback as if they were linear.

What is true with waves, applies also in general: equations that describe the dynamics of the continuum must contain – if they are to apply exactly – nonlinear terms. Taking into account these terms, one is immediately confronted with a complexity that is hardly manageable mathematically.

The second reason is that the non-linear equations of self-organization do indeed *not* follow from equation (1), but represent, as has previously been shown, a second, independent element of the description.

2. I have focused here on the concept of "causality top-down". Of course there is also "causality bottom-up" and "causality at the same level". However, about these two types of causality nothing must be said. The only problem is that currently the tendency prevails to consider them as the only two kinds of causality.

However, in order to justify causality "top-down", which is a necessary prerequisite for the autonomy of mental phenomena, it is required – as has been shown in this chapter – to change the current scientific view of the world.

3. There is another important difference between the laws of the generation of order and the laws in which the dynamics of a system is traced back to the interactions of the elements of the system:

The latter conform to the usual idea of the time-direction of causality: starting point is the present; the future development of the system is deduced from the present conditions.

The laws of the generation of order, however, contain as most important, characteristic element the concept "attractor", that is: a shape into which the system *will* develop, in other words: they relate to an entity that *does not yet exist*.

Thus the attractor concept is similar to the *causa finalis* – though only with respect to the fact that the attractor, understood as *cause*, lies in the future. (As a reminder: it must be seen as cause, because the development of the system does *not* follow from the totality of the local conditions.)

However, there is of course no purpose or intention behind this development. Real final causes exist only in the realm of the mind.

4.7. The altered Picture of Reality in the Overview

Nature unfolds from the present into the future by executing at every position the fundamental law (1).

This temporal progression of the reality cannot be reproduced in descriptions, because descriptions are lacking the metaphysical quality *activity*.

Therefore, in the description it is not sufficient to know the law and the initial conditions. In order to derive the future from the present, additional knowledge about finite areas must be available.

Expressed mathematically: it must be integrated, which, however, is not possible in the general case.

This means: no future state of a system can be completely derived in any description. The future is not contained in any description.

Thus the future does not exist, before it occurs. In other words, at any given time there is neither exactly one future nor more than one – there is no future at all. Reality is neither deterministic nor non-deterministic.

Here, again a difference between reality *in itself* and reality in a description reveals itself:

Descriptions of reality are either deterministic or non-deterministic. But reality *in itself* does not fit into the scheme of determinism and indeterminism. It eludes this alternative. Although the real future emerges from the real present, the description of the future does not follow from the description of the present.

If reality is neither deterministic nor indeterministic – what is it then?

As always, when it is asked about reality *in itself*, this question cannot be answered directly, however one can approach the answer by leaving the differential perspective and turning to the global (topological and metric) conditions.

Since the totality of the differential conditions is not sufficient to establish a procedure to generate the future from the present, the description through global parameters and boundary conditions becomes an independent element of the description.

This kind of description has a twofold significance:

1. The *emergence of order* can be expressed by non-linear feedback equations in which the development of a system is represented by time-varying global parameters.
2. Provided appropriate boundary conditions, in the phase space of such systems exist attractors, which the system approaches. *Everything that exists* corresponds to such an attractor. Therefore, the attributes of being are (approximately) constant global parameters, which relate to how the attractor structures its spacetime environment.

Global conditions are thus responsible for the emergence of order and also for the regularities that result from the order that has developed in this way: finite areas of the continuum organize themselves to entities with certain attributes and to structural laws (interactions) that occur simultaneously with those entities. In this way, a first, elementary layer of *existence* emerges, which consists of objects and laws of structure (interactions).

Also in this layer of elementary objects, however, in the general case the knowledge of the laws and initial conditions is not sufficient for the derivation of the future. Again additional order is required.

How does this order develop? In the same way as before: Provided appropriate boundary conditions, the objects organize themselves into structures and forms, and again a new, more complex layer of objects and structural laws emerges. And to understand this evolution, it is again necessary to change from the local perspective to the global perspective.

The same game can repeat itself several times, whereby again new layers of being develop. At all those layers, reality approaches algorithmic describability, without ever reaching it completely.

Back to the question, what the status of reality is regarding the alternative determinism – indeterminism.

The equations of self-organization by feedback are deterministic, i.e. the time-dependent global variables have distinct values at each time point. The local details, however, are not contained in these equations. This means: the equations do not represent a complete description of the system, and therefore the determinism of the equations cannot be transferred to the system described by them.

So it remains an incomplete determinism, which concerns only the global long-term behavior of the system.

Thus, with regard to the question "determinism or indeterminism", the following picture emerges:

- a) The totality of the local (differential) conditions is not sufficient for determining the future.
- b) The description through global parameters is indeed deterministic, but local differences are not taken into account. Thus only the pattern formation is determined.

The connection of the two statements illustrates, how the metaphysical characteristics of reality *in itself* – that is: to be neither deterministic nor not deterministic – reveals itself on the side of the description:

In the differential approach, the future does not follow from the present. In the global approach, the development is indeed determined, but only with respect to the emergence of form and structure.

Thus, if one wants to grasp reality by means of the scheme deterministic-indeterministic, one can only assign to it a qualitative, so to speak a "soft" determinism.

In this view, there is no longer any contradiction between the assumption of free will and the fact that nature behaves everywhere and anytime according to a law.

Since reality is not determined by the totality of the local (differential) circumstances, the global state, expressed by global parameters, becomes an independent element of the description, and, moreover, it can be asserted that the laws of the respective most complex layer of being, in which the attributes of the elements of this layer appear as variables, are the dominant laws.

This fact enables the justification of the principle of *causality top-down*, through which the dominance of the most complex layer is expressed.

In us ourselves, this is the layer of mental processes.

With those statements, the relationship between local and global description is clarified:

Though they are interrelated, they are still independent procedures. Neither of them is derivable from the other, their relationship cannot be formalized. Only through the combination of both, it is possible to achieve an understanding of reality that escapes the alternative deterministic – non-deterministic and in which the phenomena of mind and free will can take their rightful place.

An Aspect of physical, philosophical and religious Significance

For us, the origin of everything is AGENT that changes.

Brought into the form of a statement, it is the simplest possible fact; expressed as law, it is the simplest possible law.

The essential point is that here the principle of necessity reigns which enforces the greatest possible simplicity.

Therefore, in that, what the *origin of everything* is *for us*, there is nothing except *activity*, the metaphysical principle of the reality. If the necessary conditions of existence, space and time, are added, then the *origin of everything* assumes the form of equation (1).

But in physics, in philosophy and in the various religions, it is usually assumed that the order, into which the universe unfolds, must exist in some form already *at the beginning*.

However, the conclusions of this chapter show that this assumption is wrong. The future is not contained in the past, and the future order is therefore also not contained in the past.

At the beginning, which however is to be understood only as the beginning of the unfolding – or, more correctly, as the beginning of *one* unfolding – of the universe and not as the beginning of its existence, there is only the self-altering AGENT.

This is just it itself and nothing else – not the All-One, not God or however the religions call the primal ground of reality. It is not the "Absolute", it is no will, no intention, no "almighty reason"¹⁴⁷, no organizing principle, no order, also no "state of minimal entropy"; It "contains" nothing of what will be in the future.

It is just AGENT.¹⁴⁸

¹⁴⁷ Max Planck, Religion und Naturwissenschaft, in: Vorträge und Erinnerungen, Darmstadt 1965, S. 331.

¹⁴⁸ Analogously to the definition of the "essence of being" that will follow in section 5.3, the essence of the *origin of everything* is its unity of substance and metaphysical quality *activity*, i.e. its "in-itself-ness", as far as it can be captured conceptually. Therefore at least can be claimed that it lies in the essence of the *origin of everything* to unfold into all those kinds of being which we experience, and also into all those kinds of being which are possible at all.

Due to its differential action, it proceeds into the future by generating ordered global states.

Precisely because the differential law is just the simplest possible equation and nothing else, the greatest possible structural richness can unfold from it and from the respective emerging boundary conditions: Through the simplest possible differential law, the least restrictions are imposed on the global structural evolution.

Addition: Another Proof of the Impossibility of Time Reversal

We look at a planetary system between two instants T_1 and T_2 . Suppose we film the process from a point that lies on the straight line through the center of gravity of the system normal to its plane and is located so far away that the differences of the times, which light needs to cover the distances between the various objects of the system and our camera, nearly disappear and can thus be neglected in the following considerations.

We then play the movie reversed in time. The question is: Does the film now represent the real time-reversed process?

The answer is *no*. As follows:

Let us assume, the process was time-reversible. This means: the backward running film shows the actual backward running process. All objects move along the same paths as before, but in the opposite direction. This assumption is based on two conditions:

1. In the time-reversed process, the velocity of each object is at any point of its path the negative of the velocity that this object possessed at the same point in the original process.
2. In the time-reversed process, the acceleration of each object is at any point of its path equal to the acceleration of this object at the same point in the original process.

Now we proceed as follows: We pause the forward running film at some instant, which corresponds to an instant T between T_1 and T_2 in the real process. We look at an arbitrary object A . At the time T , it is at the position O . Let us call the totality of the positions, where all other objects are at this instant T , the constellation $C(O)$.

However, since gravitation needs a certain time to cover the distance from any of the objects to the object A, the gravitational effect, which the object A experiences in O at the time T, is not determined by the constellation C(O), but by the hypothetical constellation C'(O), which can be obtained in the following way: One starts with C(O) and moves each object on its path backward – precisely by that amount of time which gravitation, starting from there, needs to reach the object A in O at the time T.

Now we look at the backward running film. Again we stop it, when the constellation C(O) appears. However, also here applies that the gravitational effect which the object A experiences at that instant, is not determined by the constellation C(O) but by a hypothetical constellation C''(O). This constellation C''(O), however, is obviously not identical with the constellation C'(O): In order to construct C''(O), the objects must indeed be displaced – again starting from C(O) – on their paths *into the opposite direction* than before in the construction of C'(O)..

From this follows that, in the time-reversed process, the acceleration of the object A at the position O *is not identical* with the acceleration of A at the same position in the original process.

Therefore the following applies:

If the process is time-reversible, then all objects move backward in time along the same paths as forward. This is only possible if the acceleration of any object along its path is – at any point of this path – identical for both time-directions. As has just been shown, however, in none of the points this condition is met. Thus the assumption of time-reversibility leads to a contradiction; the backward running film shows no real possible procedure.

As regards our example, the difference between the actual time-reversed process that starts at T2 and the backward running film can be downright dramatic:

Suppose our system has more than two heavy gas planets. So its stability-level is low. Then it is possible that in the original process between the time points T1 and T2 all planets stay in their orbits, whereas in the actual time-reversed process – in contrast to the backward running film – several planets are thrown out of the system.

Our argument is valid for any interaction that propagates at a finite velocity. Therefore it proves that time reversal is generally impossible. There are no "reversed trajectories".

Notes

1. The proof is only valid for relative movements of the objects of a system. Due to special relativity, however, it does not apply to the (uniform) motion of the whole system, i.e. to the movement of the center of gravity of the system: whether the system *as a whole* is moving or not is physically indistinguishable.

2. Of course, the thermodynamic irreversibility arguments still apply. But they are only suited to specify – under certain conditions – one time-direction as the more probable one, while the argument presented here applies to all systems, such that irreversibility appears as ontological necessity.

3. The most important consequence of the above reasoning is the following:

Contrary to general conviction, from the time-symmetry of the equations that describe a physical process does not follow the time-symmetry of this process itself.

5. Qualia

5.1. Introduction

Now we have finally arrived at the question that contains the real secret of the mind: the question about the reason for the fundamental transformation of a network of information into a world of sensations.

How does information turn into sensation? In which way does the machine turn into a sentient being? What is the difference between the two?

For everything that has been said so far about mind, it was sufficient to regard mental activity as information processing. The autonomy and dominance of the mind, as well as the existence of free will, could be substantiated in this way.

But now, when we ask how a sequence of neuronal patterns can be a stream of experiences, an answer based only on this assumption can no longer suffice. As long as one acts on the assumption that mental processes are nothing but information processing, one remains captured in the area of information processing. It does not change anything, if one networks representations, or forms representations of representations – i.e. higher levels of information processing –, or lets information act back on itself: no matter what function is applied to information – the result will always be just information and nothing else. In this view, no metamorphosis can occur; the information "red" does not turn into the sensation *red*, the information "pressure" does not turn into the sensation *pain*.

Therefore applies:

The assumption that mind is information processing, is necessary and sufficient for the derivation of the freedom of will.¹⁴⁹ But for the substantiation of the qualia, it is only necessary and not sufficient.

In other words: The assumption that mind is *nothing but* information processing, is wrong.

First it must be clarified why qualia are not contained in any description. Thereafter we will focus on the question, why a physical and physiological state turns into a quale.

¹⁴⁹ However, this applies only to information processing in *biological* neuronal networks. More on that follows later.

Meaning

Mental states relate to each other. In the case of notions, this is a matter of course. But it is also true for perceptions: even if they represent an object, their content is still determined not only by this object but also by the relations with other elements of the mental reality.

Representations, which are not networked with each other, are not mental states. The robot *John* (section 2.2) represents the attribute of an object, which we perceive as *red*, but, in the case of the robot, this representation is not a mental state.

Therefore, networking the representation-states is a necessary condition for the possibility that representation-states can ascend to mental states.

In order to discriminate mental states and representation-states, I shall denote the *information content of a mental state* – which, according to the above notes, is not only defined by the represented object or the represented situation but also by the relations with other mental states – as *intrinsic meaning* or just as *meaning*.

5.2. Insertion: strange Conjectures

Lately, during my investigations I ran across two false hypotheses so frequently that I would like to briefly respond to them.

However I see this section not as part of the serious discussion about the topic "qualia", but rather as an entertaining insertion, to which I was seduced by an article that related to these two hypotheses and which I found so amusing that I was overcome by the desire to share my pleasure with someone else. (I'll be right back on it.)

The first hypothesis reads as follows:

If in an animal a neuronal structure is present that resembles a structure, without which humans cannot feel emotions, then there is reason for believing that this animal is capable of emotions.

The error is obvious: a necessary condition is mistaken for a sufficient condition.

Specifically it is about mid-brain structures, especially the amygdala, which is said to provide for the "emotional coloring" of neuronal processes – and this is not meant as a figure of speech, but as an ontological claim, as if emotions were colorful and the amygdala an ink pot.

What is the amygdala? A neural node. If one were to seriously ask what such structures actually can afford, the inadequacy of this paint-box idea would immediately come to light:

What are neural nodes able to do? Three things. They can

1. connect areas of the brain with each other or with other physiological structures (like extremities),
2. process information internally and in this way generate input-output relations,
3. connect the neuronal network with the chemical regulation systems of the organism.

The first two points illustrate what has been said in the introduction. Obviously, they do not lead out of the area of information, and the appearance of sensations remains unexplained.

So we come to the third point. What is meant by chemical regulatory systems? E.g. the transmitter system, or the endocrine system. Through the connection of the neuronal network with these systems, neuronal activities – and, at the same time, the objects or situations that are represented by them – are being *assessed*, in the sense that now certain behaviors are triggered or modified, which basically can be divided into two classes: Strive for or avoid.

Can neuronal structures, which connect information and behavior in this way, cause the appearance of emotions?

If one takes this assumption, one is immediately led to absurd consequences. Indeed such structures are found in every living organism, even in the simplest one, because they are necessary for survival. Each animal must be able to distinguish what is favorable or unfavorable for its survival, it needs to avoid danger and find food.

Thus also a nematode has a so-called "reward system", and according to the aforementioned hypothesis, we would now have to assume that it was capable of emotions. Given its extremely small number of neurons, however, that is not very plausible.

But if anyone nonetheless thinks it would be possible, one could present him/her the following thought experiment:

Suppose we construct a robot – let's call it *Suzy* – who behaves as follows:

If *Suzy* is touched gently, then she generates pleasant melodious sounds and rolls closer. However, if one exerts a stronger pressure – so powerful that a human already would feel uncomfortable – then she remains in place and says "ouch!" And finally, if one presses very firmly or beats *Suzy*, she whines and rolls away, screaming loudly.

It is clear that *Suzy's* behavior can be produced with the simplest means. An optical sensor, a pressure sensor and some electronics and mechanics would be enough.

Thus, *Suzy* has certainly no feelings. But she has a structure that associates information with behavior, so that approach or escape is triggered. In other words, *Suzy* has a reward system!

Therefore, the statement of Victoria Braithwaite, who examines the question of whether fish feel pain¹⁵⁰: "Although the appropriate structures and functions are much simpler than in the human limbic system, the discovery of the fish-equivalent is a most important finding" could be paraphrased by the statement: "Although the appropriate structures and functions are much simpler than in the human brain, the discovery of the *Suzy*-equivalent is a most important finding."

So the first of the two hypotheses which I criticize here is certainly wrong.

Actually, it was unnecessary to explain this in such detail, because it has been clear already before, that, on the basis of the current scientific interpretation of mind, the existence of certain neuronal structures represents only a necessary and not a sufficient condition for the occurrence of sensations or feelings.

(The fact that in the attempts to explain qualia this important difference is frequently not respected enough testifies in a certain way the explanation crisis of natural science, which however is inevitable in the current scientific world view.)

Now to the second hypothesis. It reads:

If an animal exhibits behavior which, when observed at a human, would indicate feelings, then this is a reason for the assumption that the animal feels something.

¹⁵⁰ Quoted (and translated) after Spiegel online, <http://www.spiegel.de/spiegel/0,1518,749108,00.html>

To refute this hypothesis, it suffices to recall the robot John, who behaves *as if* he had the sensation *red*, or Suzy, who behaves *as if* she felt fine or suffered pain.

"The ethologist Robert Elwood of Queen's University Belfast sprinkled the sensitive sensors of prawns with acetic solution. For up to five minutes the crustaceans rubbed their battered body parts – according to Elwood a reaction that reminds of the pain behavior of mammals."¹⁵¹

Yes, that's true, just as the behavior of John and Suzy reminds of the behavior of children. If Elwood thinks, however, his observation was an argument that crustaceans feel something – and probably he thinks so, because why else would he have spoken in this way – then one must inform him that from his observation only follows that prawns rub their sensors, if they have been wetted with acetic solution, and nothing else.

It is rather amazing that such statements find attention at all. Obviously, from the rubbing of the sensors nothing more can be concluded than that a certain stimulus triggers an associated behavior which may then last even longer than the stimulus persists. Everything else is not a conclusion, but the expression of subjective inclinations.

Just to not be misunderstood: If a person – let's call him Robert – prefers to embrace his prawn instead of eating it, or if another person – let's call her Victoria – wants to share her good fortune with a nematode, then I would be the last one who tried to stop them; – and I am serious about that, because I consider the variety and diversity in the garden of humanity a high value, and I think it would be unfortunate if its soil would be so poisoned by our rationalization- and optimization-mania that only the greed for money, power and pleasure could thrive on it.

But I'd suggest Robert and Victoria, to simply follow their inclinations, and not seek to substantiate them in an ostensibly rational manner.

Finally, as funny conclusion, a statement by the author of the cited article himself:

"To many experts [...], the absence of the cerebral cortex alone no longer seems to be sufficient to rule out conscious sensations. Doubts about the old doctrine are not least nurtured by amazing medical case histories: Occasionally, neurologists report on people with only half the cerebrum. Where in others brain cells talk, in them just neural water swashes – and yet they are often highly intelligent and socially inconspicuous."

¹⁵¹ Quoted (and translated) from the same report.

Yes, and if one sees a three-legged dog run, then one wonders involuntarily if the old doctrine that dogs need legs for running shouldn't have been revised long ago!

5.3. Why Qualia are not contained in any Description

Once again: the Problem

The failure of the current scientific view of the relationship between neuronal networks and mind reveals itself in the confrontation of the following two issues. Both are so well secured that they can claim the status of facts.

1. Regardless of how one describes or analyzes the brain or a region of the brain, one will always find just informational or representational states and never a *quale*.
2. The neuronal system brings forth *qualia*. Its states *are* qualia.

The *thing* that can be observed and described is a *dynamic neuronal excitation pattern*. It can be understood that this pattern *represents* something.

But that which this neuronal pattern *actually* is – the *quale* – seems to transcend the physicalness of the described thing in an inexplicable way.

Whence comes this irreconcilable difference between what it *is* and as what we describe it?

I think that through the last formulation it has become clear where the explanation is to be found: In the analysis of the relationship between actually existing things and things in a description, which was carried out in Section 1.3 of the Second Part of this book. The following subsection provides a brief recap with a few additions.

Substance and Accident; the Essence of Being

Reality *for us* consists of *things* that have *attributes*. What remains, if one imagines all attributes removed from the thing?

Obviously *nothing*, because a thing without attributes does not exist.

But *nothing* cannot have attributes. What is to be concluded from this contradiction?

It must be concluded that the actually existing thing, the *thing in itself*, does not correspond to the thing in the description, the *thing for us*.

What is the difference?

An actually existing object cannot disappear if all attributes are removed from it – simply because *nothing* cannot have attributes –, whereas an object, which is only an element of a description, indeed disappears completely if all attributes are removed.

This difference can be expressed in the following way:

Actually existing objects consist of *substance and accidents*. Objects in a description consist *only of accidents*.

Any description consists only of accidents. A description is always a network of relationships between objects that are defined by these relationships. The objects consist entirely of this definition, they *are nothing but this definition*, and therefore they disappear completely if the attributes are removed that are the prerequisites of the relationships.

Thus the substance cannot appear in the description. It is just presupposed through the assumption of the existence of the described thing. This defect of descriptions is irresolvable. It represents an insuperable limit of our thinking.

Yet the difference between reality and description can also be determined in another way:

There is no object that merely exists. Existing means interacting, and interacting means being active. An object that is not *active* does not exist.

Although in the description the *kind* of activity can be displayed through its attributes, the *activity itself* is still lacking. Objects in a description are always *passive*.

Therefore, what descriptions are lacking can be captured by two concepts: *substance* and *activity*.

These two concepts are inseparably connected with each other.

Before there is any being, their connection represents what the *origin of everything* is for us: the *first substance*. I call it AGENT. *For us* its metaphysical quality *activity* becomes the first accident "activity". Both together is activity of AGENT.

On being itself, the substance represents not only the condition for its existence, but also that from which the metaphysical quality *activity* of the being emanates, which drives the respective accidents – but only in the reality; in the description, the accidents lack this quality.

I have already spoken several times of the essence of being. Now I will catch up for its definition

Definition

The essence of a being is this being as unity of substance and accidents. It is the "in-itself-ness" of being, as far as it can be captured conceptually.

The essence of being cannot be thought. At the same time, however, it does not remain hidden. It can be approached conceptually.

I shall demonstrate this using the example of the essence of the physical being.

The first substance is AGENT. Even if AGENT cannot be thought, we nonetheless know something about it: we realize that a thing from which all attributes are removed – though it does indeed no longer exist – is still not just identical with the purely conceptual nothing, because the conceptual nothing could not have attributes.

Thus AGENT must be different from the conceptual nothing.

Now this distinction in turn makes it possible to determine the *ontological status* of the first substance:

The first substance cannot be *nothing*. However, since it lacks all accidents, it can also not be *something*.

Therefore, its ontological status is neither that of *being* nor that of *not-being*, but *necessity* – simply because there is no alternative for its neither-being-nor-not-being: If we thought the first substance as not-existing, then we would have chosen *nothing* as its ontological status, which means: one of the two alternatives that we have ruled out previously.

Already through these first steps it becomes a little clearer what is meant by "conceptual approach" to that which is actually unthinkable.

Let us repeat a few more steps of the derivation, which was conducted in the early chapters of the Second and Third Part:

Activity means change. However in order to achieve a statement from which the description of reality can follow, two different changes are needed.

Since space is a necessary condition of reality, and because without motion there is no change, one of the changes must be a change of space and the other one a change of motion.

Since there is no size, the changes can only be relative and cannot relate to an absolute measure.

Since there is no memory, the temporal change of motion must relate to the respective differentially adjacent preceding moment, that is: it must be expressed by the differential quotient dv/dt .

In this way, one arrives at the idea of a metric continuum, which consists of accelerated flows, where the acceleration depends on the alteration of the relative spatial density (of length or angle).

This means that every being is a pattern of alterations of the movement of the continuum, and, because every being conserves its form over a certain time period, it also means that every being is either an attractor of the local continuum dynamics or a part of an attractor of the global continuum dynamics.

With this, a further approach to the essence of the physical being has taken place. Through the just performed conclusions, the first substance AGENT has turned into a space-time-continuum, and the first predicate *alteration* has assumed the form of equation (1), which represents the law of this continuum and expresses, what the physical reality is *for us*: a fabric of differential spacetime alterations.

Let us dwell a little longer on the concept of the continuum, because by using this concept can be illustrated very clearly how far and to what limit the concept of *substance*, which cannot be thought directly, opens up to our thinking in an indirect manner.

What is a continuum?

For the sake of simplicity, let us look at a one-dimensional continuum. In standard analysis, the points of the continuum are mapped to the real numbers. This suggests that points *exist*.

But points have no existence! So if we say that in the continuum exists an accelerated flow, then this statement is only mathematically meaningful; if it is understood ontologically, then one is immediately confronted with the fact that actually *nothing* moves.

Another question is to *which kind* of numbers the points of the continuum actually can be mapped.

At first, it may seem surprising that the rational numbers do not suffice, though they are infinitely close to each other, which means that between two rational numbers, no matter how close they are, there are always infinitely many other rational numbers. Yet, as is easy to prove, there is still room for uncountably many more, namely the irrational numbers.

And then?

For a long time, mathematicians thought that the numbers would then be complete and that, if they are thought as points on a line, all possible points of the line were captured. But non-standard analysis shows that further numbers can be defined that again lie *between* the previous ones. This process can be continued *ad infinitum*. It is solely our decision when we stop.

This means that the continuum is a limit-concept. Ultimately, we cannot form an idea of it: if we divide it, then we lose it – but to describe it, we *have to* divide it.

Nevertheless, it is undeniable that the mathematical formulation *accelerating continuum flow* contains more information than the verbal expression *change of AGENT*.

And exactly this approach, this increase of knowledge that is connected with the reasoning about the continuum, enables then further conclusions about the reality developing thereof.

If we investigate the continuum, then we learn more about the operations that are possible in it. If there are infinitely many, then, though we will never know them all, there is still no reason for the assumption that any of the accidents remains hidden for reasons *on principle*.

So we can rule out with some certainty that the first substance contains any secret which will elude our understanding forever.

Thus the relationship between our thinking and the concept of the essence of being is determined as follows:

The essence of being cannot be thought *as such*, because neither the substance itself nor the unity of substance and accident – the continuum that exists only as changing – can be thought

On the other hand, the accidents must be regarded as *manifestations* of the substance, and therefore applies:

Whatever *activity* the essence of being contains *must* manifest itself as accident, because otherwise it would not be there. For this reason, it can be asserted that the essence of being reveals itself through its accidents.

Therefore, the essence of being contains no secrets. Everything in it is revealed through its accidents. It is not thinkable, but also not hidden.

Since any being is a pattern of alterations of spacetime – that is: of the *origin of everything* – the question arises whether being possesses also its ontological status *necessity* and its metaphysical quality *activity*.

Obviously, *necessity* is not transferred from the *origin of everything* to being: as pattern, it can dissolve. Every being stands in the alternative *be or not-be*. Necessary is only *that* something exists, but not *what* exists.

However *activity*, the metaphysical quality, is indeed transferred from the *origin of everything* to being. It appears in the form of the respective accidents; it is the *drive* behind the accidents of the actually existing things, that, what distinguishes the accidents of the actually existing things from the accidents of the things in a description.

The Answer

We perceive the table, and we think we know what it is. But if we try, to follow the question of what it is up to its ground, then what it is disappears.

Precisely this disappearance of the substance has been encountered by the natural science of the 20th century, and it has plunged physics – though there is no longer much awareness of this issue – into a crisis from which it has not recovered to this day, because it has failed to capture the facts conceptually.

We perceive the waves moving towards the shore, and we think we know why they move. But the concept of energy is inappropriate for the explanation, because it is defined only mathematically and does not provide any differentiation between reality and description. Therefore, to the question of why anything moves at all, there is no answer before it is realized that the essence of being is *activity* and that this essence gets lost in the descriptions of reality.

This means: Being is always *more* than its concept, more than as what it appears in our perception and in our descriptions. It is always *substance and accidents*, whereas in the perception and in descriptions, *only accidents* appear.

That, what being actually is, its *essence*, the unity of substance and accident, is unthinkable for us. Thus we do not know about *any* being what it is. Only the confusion of reality and description – which, regarding material things is so habitual to us that we do not notice it – gives us the impression that we knew it.

The actually existing table is *more* than the table that we perceive and think. The actually existing wave is *more* than the wave that we describe.

And, with this, we have finally arrived at the answer to the question of why an *existing* neuronal excitation pattern is *more* than a *thought* or *described* neuronal excitation pattern.

According to what has just been said, it is neither surprising nor difficult to understand why states of the neuronal network are not merely that, as what they appear in our description, but rather self-evident and necessary. They *must* be more than that, because their description can only contain that part of the state, which can be captured by a description, that is: the *accident*.

What is in this case the accident?

That what can be conceptualized, that is: the *definition* of the respective object, which, in the case of a neuronal pattern, consists of the information contained therein, i.e. of its *intrinsic meaning*.

This brings us to the following insight:

Mental states have an information content and a feeling content. The information content, the *meaning*, is the accident.

However, as everything which exists, also a mental state consists not only of *accidents*, but also of *substance*. Thus it is *more* than meaning.

What is, in the description, missing of this "more-ness", what is lacking of the whole being, of the *essence* of the mental state?

SENSATION. Therefore, SENSATION is the *substance* of mental states.

Proposition

Mental states are qualia. Meaning is their accident, SENSATION is their substance. As such, it is not contained in any description

The essence of the quale is its unity of SENSATION and meaning.

With this, we have solved the first part of the problem about the qualia: the question of why neuronal patterns as *existing* entities are **more** than the objects, as which they appear in our descriptions, and why this "more-ness", the *quale*, is not contained in any description.

Let us now turn to the second part of the problem: the question of why the substance in the case of qualia is not the same as in the case of other kinds of entities.

5.4. The Transformation of Being from the material Thing to the Quale

First and Second Substance

It has now become clear why we have called SPACETIME the *first substance* and *change* the *first accident* evidently, *mind* is an area of reality, where the essence of being has changed; here, being consists not only of other *accidents* but also of another *substance*.

I denominate SENSATION, the substance of the mental states, as ***second substance***, and ***intrinsic meaning***, their accident, as ***second accident***.

However, the second substance is not to be thought as independent from the first substance or juxtaposed to it; **the second substance emerges from the first substance**.

How this emergence of mind from the neuronal network, this transformation of the physical being into the quale takes place is the subject of the subsequent investigation.

Let us first clarify the question of what is to be expected from such an investigation.

It must be explained *why* a transformation of the substance takes place. But it can *not* be postulated that this explanation contains a derivation of the essence of the mental states; however, this is an obvious limitation, because something that is not included in any description, cannot be derived either.

This restriction, however, does not represent an absolute barrier, because it is possible – as with the physical being – to approach the essence of mental states conceptually, even if it cannot be thought; – or say rather: cannot be *described*, because we actually *know* what qualia are.

Strictly speaking, qualia are in fact the only being, of which we know what it is, because our consciousness is a constant stream of qualia. Not only what we feel, also what we think and what we perceive is a quale. Even the most abstract intellectual activity is carried by an interest and guided by a motive, and both interest and motive are descendants of sensations from which they cannot be separated.

So how does the second substance emerge from the first? Why is the essence of being transformed?

The Reason for the Transformation

We can act on two assumptions:

(1) The transformation of the essence of being from the material object to the quale occurs through the unfolding of nature into layers of increasing complexity, whose governing laws have been described in the previous chapter.

(2) The part of this rise, which is conceptually accessible for us, is the part that occurs on the side of the accidents. Thus, there the argument must take place.

First a designation: To the essence of being in that area of reality in which there is no mind, I'll assign the term "matter". (Thus, this term "matter" does not only contain the accidents – as is usual in physics – but also the substance.)

The point which we must direct our attention to is the question:

Why is the essence of being transformed only concomitant with the development of neuronal networks of high complexity which bring forth mind, while up to that point it seems to be uniform throughout – at least to such an extent that only at this point we are compelled to introduce a second substance?

We manage with some success, to describe the phenomena we find in the material world. Where our knowledge is incomplete, as in the case of the origin of life, this gap can at least be filled by scientific hypotheses. Problems that we meet in the description of nature usually appear as *technical* difficulties, and we never encounter a phenomenon that seems to escape our understanding *on principle* – but that holds true only to the point where the unfolding nature generates neuronal networks of high complexity.

With their development, at the same time a phenomenon appears that eludes not only scientific description but indeed *any* kind of description: *sensation*.

Let us now begin with the train of thought which, at the end, will let us realize the necessity of the transformation of the first into the second substance.

What happens when, due to the unfolding of nature into entities of increasing complexity, the substance changes?

The answer follows from the definition of the substance: substance is a part of the essence of being, and it is that which remains excluded from descriptions.

Thus, if the substance is transformed, then we are confronted with a being whose essence is incomprehensible *in a new way*, a way that seems different from the one of the essence of beings, whose substance remains the same.

However, this may sound strange and vague: How can the transformation of something that does not occur in descriptions manifest itself? Does it make sense to speak of different kinds of the indescribable?

That, what happens when the essence of being changes, and how this change becomes apparent, can be illustrated with reference to that case where it actually occurs: the transition from matter to mind.

As stated above, we can neither think the substance of the material being – the spacetime continuum – nor its essence, that is: matter defined as pattern of spatio-temporal changes conserved over time.

But our inability is a *specified* inability. We have pursued, what is beyond our thinking, to the limit and, in this way, conceptually captured the continuum as far as possible: through the concept *limit* (of a sequence or function), we have made operationally available what we cannot think.

But the methodological approaches to the incomprehensible, in which we were so successful that we could almost forget that, ultimately, it *is there*, fail completely, if we try to apply them on what is inexplicable in that kind of being which belongs to the realm of the mind.

Obviously, we do neither come any closer to the substance of mental entities – SENSATION – nor to its essence – the quale, the unity of SENSATION and meaning –, if we regard them as patterns of spatial and temporal changes.

However this statement has to be qualified: Of course, mental entities *are* patterns of spatio-temporal changes – all that exists is indeed such a pattern – but in this statement the term "are"– unlike in the case of matter – must not be understood in the sense of a definition of the essence. The essence of material things is determined by the fact that they are spatio-temporal patterns, but the essence of mental things is that they are qualia, and not that they are spatio-temporal patterns.

Therefore it can be asserted:

The occurrence of a second substance is revealed to us by the appearance of phenomena, whose essence is inexplicable to us in a new way, such that the hitherto reliable intellectual means of approaching the inexplicable fail.

However the "means of approach" are nothing other than the accidents that are connected with the substance; the substance manifests itself through its accidents, and it is revealed to us through their investigation.

With this, we have determined *one* direction of the relationship between the transformation of the substance and the change of accidents:

If a new substance occurs, then also the accidents change.

Here is a short version of the just performed conclusion:

The accidents of being are manifestations of its substance. As such, they enable us a conceptual approach to that which is actually unthinkable: to the substance.

Now, if a new being with a different substance appears, then the conceptual approaches must aim at another goal, and this means that the thought processes required for approaching the new substance must be different from the previous ones. In other words: the accidents have to change.

What about the reverse? Does a new substance appear if the accidents change?

It can be seen immediately that in general this is not the case. In the evolution of being, in any new emerging layer also new accidents appear, without the substance being transformed.

A transformation of the substance takes place only at the transition to the last, most complex layer of reality, to beings that have a neuronal network that is sufficiently complex to bring forth mind.

With this, we have arrived at the determination of the logical point, where the elucidation of the question of the transformation from matter into mind is to be found:

The answer to the question, why the essence of being changes – such that mind emerges from matter – must arise from the analysis of the difference between the kind of alterations, which occur in the accidents due to the evolution of complex neuronal networks, and the kind of alterations, which occur in the accidents due to the evolution of new layers of reality of lesser complexity.

So, wherein consists this difference?

Let us first consider some of the accidents that occur in the formation of new layers of being.

We start with an accident that occurs even at the simplest being: gravity. If mass is understood as that *from which* gravity emanates, then mass is part of the substance of all material objects.

In the Second Part has been shown that the gravity of an object follows directly from the law of the continuum, if an additional condition is imposed on the metric density of the surrounding space.

This does not mean, however, that any state of a real physical system of the type "material body with its gravitational field" can completely be derived from a state of the universe *before* the formation of particles that have mass and are surrounded by a gravitational field.

Only the much weaker claim applies, that the accident *gravity*, when viewed in an idealized form – i.e. without any interference from outside and in full equilibrium –, appears as ordered state of the longitudinal flow, and that all the effects that this flow-state exerts on other objects, can be traced back to the law from which it arises.

In this sense, then, the accident *gravitation*, which appears in the first and simplest layer of being, can be *reduced* to the underlying layer, that is: the continuum with its law.

On the side of the substance, this reducibility of the accident means that the concept "mass" can be eliminated without loss from the description of nature. It is not necessary to regard mass as a new substance, i.e. as a new inconceivable metaphysical entity.

Let us now consider an accident, which belongs to a much more complex layer of being: as (random) example, we choose the so-called *gluconeogenesis*, which is the formation of glucose in cells. This process – as most metabolic processes – is very complex and consists of a series of individual processes.

In our context, however, only the following is of interest: While it would be impossible to derive the gluconeogenesis from any states of the universe that existed before the evolution of cells, it can still be asserted that all steps, which in cells must be run through for the formation of glucose, can be described and understood as *biochemical processes*.

Thus, in this respect, the gluconeogenesis, which appears as accident of cells, does not differ from gravitation, the accident of all material objects: both can be understood through reduction to the respective underlying layer of reality. They appear as *functions* of this layer.

One last example: processes which take place in neuronal networks that are not capable of producing mind. (That such neuronal networks exist can be presupposed. One could for example model the behavior of the robots John and Suzy by neuronal networks, and these would then be networks of this kind.)

The accidents of such processes can be summarized under the term *information processing*.

Information processing consists of input-output relations. If these relations are not altered *internally* – through networking with other such relations and the feedback resulting thereof – but remain always in (nearly) identical form, they can be regarded as functions of the given architecture of the neuronal network and of outside conditions.

Then also the behavior of animals that have neuronal networks of this kind can be regarded as function of this architecture and of outside conditions.

Thus also in this example holds true:

The analysis of the accidents shows that they can be understood as functions of the underlying, simpler layers of being.

We have thus reached the following insight:

In all evolutionary transitions to new, more complex layers of being – up to and including neuronal networks that are not capable of producing mind – the accidents, which occur in the respective new layers, can be described as functions of accidents of simpler layers of being.

The last example has brought us already close to the realm of the mind. So let us now take the last step. Let us pose the question:

What is the difference between the accidents of mental states and the accidents of other beings?

Does from this difference also follow – as postulated for the explanation of the transformation of the substance – that with the transition from the Material to the Mental another kind of change of accidents occurs as with all the transitions that remain within the realm of the Material?

According to the above, the answer seems obvious:

Let us look at a neuronal network that brings forth mind. As necessary prerequisites that neuronal patterns which represent something – which we have identified as attractors of the neuronal dynamics – can turn into mental states, hitherto two conditions have been determined:

- The existence of functionally unbound areas, the dynamics of which is open for the structuring through such attractors.
- The networking of the attractors with one another.

Representations can relate to external conditions or to body states. But also the information content of a neuronal state itself can be represented. Such meta-representations are, for example, required if alternative courses of action are to be weighed against each other.

The crucial point for our question is this:

From Hebb's law follows that the mental activity acts back on the neuronal structure. Thus the mental activity changes its own neuronal encoding; it changes *itself*.

The postulate that the representation states are networked with each other is tantamount to the occurrence of feedback loops: state A influences state B, state B influences state C, which in turn acts back on state A etc.

On the one hand, such feedback loops enhance already existing patterns, on the other hand, they can also enable connections between patterns which were not connected before. With this, the information content of the neuronal patterns changes: it is increasingly determined by the *internal* relationships between the neuronal patterns, whereas the original functional dependency recedes into the background; representational states develop into intrinsic meanings.

This is true even for perceptions: even if they remain, as neuronal representations of real objects, bound to these objects as regards their information content – in the primary visual cortex, the neuronal image of an object, which is observed twice under identical conditions, will in both cases be almost identical – they are, as *mental states*, by no means limited to this representational function. Perception includes any kind of information processing that occurs in the respective cortical area in addition to the processing of the purely sensory information, and a halo of accompanying associations is also part of perceptions.

In the case of mental states, which are not directly linked to outer objects, there is no principle limitation at all for the changes which they are subjected to in the course of their further inner processing within feedback loops. In trains of thought, surprises occur: new conclusions result, new concept formations are required, fallacies must be corrected. In the area of fantasy, the change of existing and the creation of new intrinsic meanings is even the characteristic feature, and the relation to outer objects fades away or tears off completely.

From this follows the sought differentiator:

Intrinsic meaning, the accident of mental states, cannot be understood as function of accidents of simpler (atomic, molecular, biochemical, neuronal etc.) layers of being.

A mental state gains its meaning through its position in the network of mental states, i.e. in the network of meanings. Although perceptions and judgments remain bound to the real world, it is – due to the permanent change through feedback loops – impossible to assume any kind of functional dependence of the meaning of mental states.

Shortly before we had found:

In all evolutionary transitions to new, more complex layers of being – up to and including neuronal networks that are not capable of producing mind – the accidents, which occur in the respective new layers, can be described as functions of accidents of simpler layers of being.

So this is the difference, which is the reason that the substance of being – and hence also its essence – changes only at the transition from matter to mind, whereas it remains unchanged at all other transitions from one layer to the next higher one.

But does this criterion also provide an *explanation* as to *why* the substance of being changes at the transition from matter to mind?

Yes. As follows:

Substance and accident are *inseparably bound* to each other: a thing without attributes – physically spoken: an object that does not interact with anything – has no existence.

The *first accident* is bound to the *first substance*. What can be said about complex accidents and their substance?

If complex accidents can be described as functions of simpler accidents, then follows that, ultimately, they can also be reduced to the first and simplest accident. *For us*, however, *reducibility* means *ontological identity*: If B can be reduced to A, then B *is* ultimately A. Thus, if a complex accident can be reduced to the first accident, then it *is* ultimately the *first accident*, and then it is also inseparably bound to the *first substance*.

This means: As long as the accidents are reducible, the substance remains identical. Likewise applies: As long as the substance remains identical, the accidents are reducible.

And from this follows:

If accidents appear that cannot be reduced to simpler accidents, then their substance must have changed.

Therefore, with the emerging of these accidents, also a transformation of the substance must have taken place.

Proposition

As long as accidents of higher complexity can be described as functions of accidents of lesser complexity, the substance remains the same.

If this functional dependence disappears, then the substance changes. *For us* it appears then as a new, second substance.

In the area of matter, the first condition is met. Each material being can be understood as attractor of the dynamics of AGENT, as pattern of spacetime alterations. This is the essence of the material being.

In the realm of the mind, the second condition is met. Intrinsic meanings, the accidents of mental states, can in no way be understood as functions of accidents of the underlying layers of being.

Therefore, the essence of the mental being is different from the essence of the material being.

With this, the question is fully clarified, why the emergence of mind from matter also leads to a transformation of the essence of being.

Notes

1. The core of the argument, with which the transformation of the essence of being is substantiated, is the interruption of the connection between the mental accidents and the first accident. With this, also the connection between the mental accidents and the first substance tears, whereby the assumption of a second substance is forced.

Here, I have presupposed that "connection" is equal to "reducibility" (of the accident, not of the given state of the system).

It would also be possible, however, to replace the assumption of reducibility by the weaker assumption of *explicability*. Also explicability could serve as differentiator between the accidents of the qualia and accidents of material beings, because the intrinsic meaning of mental states can only be explained through mental relations and not through any material accidents.

Although the weaker assumption would be logically preferable, I have decided for reducibility as the distinguishing criterion, and here is why:

The connection between substance and accident is of a metaphysical kind: *inseparability*. Therefore, if complex accidents remain connected with the first substance, because between them and the first accident a connection is mediated by the accidents that lie in between, then, accordingly, this connection must be the closest connection possible between accidents of different hierarchical layers in a description of nature, and that is indeed reducibility.

2. The content of the just derived proposition can also be expressed in the following way:

What in the description of reality appears as reducibility of the attributes of complex objects to the attributes of simpler objects, manifests itself in the reality as identity of the substance: the substance remains SPACETIME, and what happens can (ultimately) be seen as *physical process*.

What in the description appears as formal independence of attributes, means ontologically the change of the substance and the transformation of being: the substance becomes SENSATION, and what happens must be seen as *mental process*.

3. The reason for the transformation of being can also be understood in a simple and intuitive manner:

If the functional dependencies of neuronal states from their material preconditions fade away and disappear ultimately, then this means that, here, an area of the universe decouples from the rest of the universe. Thus a new, separate universe emerges, a *universe of qualia*.

Meanings are the accidents of the entities of this universe. They must be connected with a substance, and their separation from the rest of the universe and its substance SPACETIME suggests that to these accidents a new substance belongs.

Substance is that, which provides the accidents with the metaphysical quality *activity*. So one can ask: what is it, which provides the entities of the universe of the qualia with *activity*? Whereupon is the dynamics based in this universe?

The answer is SENSATION. SENSATION is what drives the qualia. Therefore, SENSATION is the substance of mental states.

By contrast, meaning – that, which is subject of descriptions, i.e. the formal definition of mental states – is *passive*. Meaning is *information*, and information processing alone – as everything that is just an element of a description or of a model – does never occur *by itself*. It requires activity from outside.

But it need not be specifically emphasized that this universe of qualia is an *inner* universe, a universe *in the head*. The functional decoupling, which manifests itself in the free flight of thoughts and ideas, does not mean, of course, that the mind, as esoterics and members of various religions believe, can in fact liberate itself from its spatial and temporal boundedness. It is brought forth by the neuronal network, and thus it remains bound to material conditions and captured in space and time.

4. Since substance and accidents always belong together, it is unsatisfactory to assign different accidents to different layers of being, but still to assign to them the same substance.

However, there a conceptual problem emerges. More complex accidents can be reduced to simpler ones and finally to the simplest accident. But, in the literal sense, this cannot be said about the substances that belong to these more complex accidents, because the substance can not at all be captured conceptually, such that the notion of a "deduced substance" in its literal meaning would be nonsensical.

However, it is possible to *define* such a notion and, in this way, to discriminate it from its literal meaning.

So we define:

Deduced substance is a substance, which is connected with a deduced accident.

Thus each being, which is not a mental being, consists of a deduced substance and deduced accidents. Only the *origin of everything* consists *for us* of the first substance and the first accident.

Since we understand only the accidents of being, not only a part of the essence of being remains withdrawn from our concepts, but also a part of the change of the essence of being, which occurs during the rise of being to ever more complex forms. All we can do is to conclude from the side of the accidents to the substance and its changes.

It is important to keep in mind that also the substance SPACETIME of the physical being cannot be thought, and that already for this reason alone it is impossible, to conceive its transformation into the second substance SENSATION of the mental being. As has just been demonstrated, however, it can be proven that this transformation must take place.

5.5. Criterion for the Occurrence of Sensations

The considerations of the previous section result in a criterion for the occurrence of qualia.

The existence of a quale implies that its meaning cannot be read from its material structure. This condition is satisfied if and only if neuronal states that represent something or produce input-output relations are networked with each other. Then feedback loops occur in which the information encoded in the neuronal states is determined to an increasing extent by the mutual relationships of the neuronal states, while the original dependence from outer conditions diminishes. That, which initially has been *representation*, turns into *intrinsic meaning*.

There is no way to determine what a neuronal pattern means. This is even true for perceptions: here, it can at most be determined what they represent, but not what they mean. Contrary to the high hopes of neuroscience, it will never be possible to eavesdrop on someone's mind – unless he voluntarily tells what he thinks and thus allows the identification of the individual neuronal encoding of these thoughts. But, with certainty, even that will be possible only for simple, standardized mental processes.

As already mentioned several times, the just described process of the emergence of intrinsic meaning – and thus also the formation of qualia – can take place only if there is a neuronal structure that is not functionally predefined.¹⁵²

In humans, this structure is the cerebrum. Its functional independence becomes apparent through its plasticity: if areas fail which, over the course of the individual development, have taken certain tasks, then these tasks can be adopted by other regions.

But also other brain structures can meet the criterion of functional independence. The brain of octopods is structured very differently from our brain, but most likely it contains neuronal areas of this kind.

On the other hand, the neuronal structures of the diencephalon are not suited to network representations in such a way that they can detach themselves from their original function and develop into intrinsic meanings. Regardless of whether this function is part of a genetic program or imprinted by external conditions – the behavior remains schematical and always related to the triggering stimulus. Representations that are integrated into such functional sequences can change only within narrow limits.

¹⁵² Such structures appear when a mutation causes the enlargement of an already existing neuronal structure, e.g. of an area of the diencephalon.

Therefore, in brains which – in addition to the evolutionarily even more ancient neuronal fields – contain only structures similar to those of our diencephalon, most likely the emergence of qualia is not possible.

Thus the necessary condition for the occurrence of qualia is:

Qualia occur in a neuronal network if the network contains functionally unbound structures, which permit the networking of neuronal representation states.

However this is only a necessary condition. Can also a criterion, i.e. a necessary and sufficient condition, be formulated?

I think yes. It reads:

Any animal that has a neuronal network which contains functionally unbound structures, experiences qualia.

It must be emphasized that this statement applies only to an animal and not to a robot. We could provide the robot Suzy with the luxury of an additional neuronal module, which we simply connect with the already existing neurons, without specifying its functionality. Nevertheless, it can be excluded that Suzy will have feelings.

In an animal, however, it can be presupposed that its species has already proven its viability, and this is a very strong condition. It includes a lot of technical requirements, of which we know only a few *exactly* and most *not at all*.

The claim that an animal with such a neuronal network experiences feelings is based on the following argument:

There must have been viable progenitors of this species, in the brain of which the neuronal structure similar to the cerebrum has not yet been present at all or only to a very small extent. Presumably, the organism we are looking at would thus be viable also without the "free" neuronal structure, and the neuronal network would contain all functions, which are necessary for the appropriate regulation of its behavior.

But if now this new, initially function-free structure is added, then *inevitably* meta-representations and networked representations will arise, because the information about the environment and the body *must* in some way arrive in the new structure and there be processed further – but again only if the

neuronal extension is a continuation of a neuronal tissue, which has already proven its ability to function correctly and is not just a bunch of neurons.

This condition, in which again many technical prerequisites are summarized, is certainly met in an animal.

With this, however, it is already proven that this animal has feelings.

A simple additional Argument

The existence of feelings presupposes that there is *somebody who* feels

Consider the sensation *pain*: the sensory information can only turn into the sensation *pain* if there is a *subject* who takes note of the sensory information.

It is not necessary to determine more precisely what is meant by the terms "somebody" or "subject". It suffices to realize that in a neuronal network, in which only automated processes that are either genetically programmed or imprinted by environmental conditions, there is no room for this postulated subject.

The assumption of a subject presupposes that stimulus and behavior are not in any case in a fixed connection with each other, like in the case of a reflex or of a learned program. There must also be cases, where the sensory information does not lead directly to the stereotype behavior but *further processing* is applied. Therefore, the neuronal network must be capable of *meta-representations*.

But obviously, a single meta-representation alone does not suffice to substantiate the assumption of a *subject*. For that, it is required that the meta-representations are stored as memories and networked with each other.

Only then is it justified to assume that there exists *somebody who* feels.

So this simple argument leads again to the necessary condition, which has just been derived: For the appearance of feelings, the existence of a functionally unbound neuronal structure is required, which enables the networking of the neuronal representation states.

It must be noted, however, that this is a *structural* argument, and therefore it is, like all structural arguments, inappropriate to substantiate the *metaphysical fact* of the transformation of neuronal states into qualia. It can only serve for the determination of necessary conditions

5.6. Who or What has Sensations?

The above formulated criterion for the occurrence of sensations permits drawing a boundary between *machine* and *sentient being*.

The actual classification, however, requires precise knowledge of the structures of the respective neuronal network and their performances. As mentioned, the intelligence of birds has been underestimated for a long time, because it is not located in the same neuronal area as in the case of mammals. By now, however, it is well known that some birds are highly intelligent. Birds undoubtedly have sensations.

What about fish? The discovery of structures similar to our diencephalon does *not* represent an indication of feelings. But the question arises whether the complex behavior and learning ability of some fish species suggest the existence of neuronal structures that meet the criterion of *functional independence*. Perhaps there are fish species in which this is the case.

Some questions, however, can be decided unequivocally using the criterion:

Do bees perceive colors? No. Although different colors are differently represented in their neuronal networks, the representation remains pure information. A transformation into SENSATION does not take place.

Do Crustaceans feel pain? No. They are not sentient. The relationship between Robert and his shrimp will remain one-sided.

On this side of the border, which is drawn by the criterion, there are no sensations. But what is on the other side? What if the initial function-free cerebral-like structure is *very small*?

Are then feelings somehow "paler"? Is *red* less reddish? Is *pain* less painful?

On the one hand, it must be remembered that the indescribability of feelings is transferred to their gradations. It is not possible to describe gradations of something that is not describable.

On the other hand, with feelings we have this special relationship that, though we cannot capture them by descriptions, we still know exactly what they are because they are *directly* – as they themselves – given to us.

Therefore I think that the idea of "paler" or "weaker" emotions and a "dull" or "vague" consciousness is a suitable approximation to the nature of those qualia, which animals experience, in which the functionally unbound neuronal structures required for the emergence of qualia are less pronounced.

An important aspect of the conclusions of the previous section is that – also in neuronal networks which are capable of forming qualia – qualia are not present from the beginning. The transformation of matter into mind, of representations to intrinsic meanings, of a neuronal pattern into a quale is a development process.

From this follows, for example, that infants do not *perceive* colors after their birth; even later, when they are already able to *distinguish* colors, initially they cannot have any color sensations – just because the information did not have time to develop into a quale.

5.7. Attempt of a conceptual Approach to the Transformation of the Substance

The fact that the first substance SPACETIME is transformed into the second substance SENSATION is at first disconcerting – even if the necessity of this transformation can be realized. This irritation can be reduced in various ways.

First approach

The first step is certainly the realization that here the concept SPACETIME is not identical with the mathematical-physical concept "spacetime". This concept is only *defined*, which means: it consists only of the accidents by which it is defined, whereas the substance SPACETIME denotes that, which *has* these attributes, that is: that what the physical spacetime "is" *without* these attributes, where the quotes indicate that the ontological status of SPACETIME cannot be "existence".

Therefore, that which is transformed is not the physical "spacetime" – this idea would be outright absurd – but the unthinkable first substance SPACETIME.

Second approach

If we try to think *spacetime* as substance, it turns into AGENT. What we know about it is that it has in it the metaphysical quality *activity*.¹⁵³

Material objects are spacetime patterns. Therefore it is possible to define their substance by the concept-pair [spacetime, activity]:

Material substance := [spacetime, activity]

Mental states are also spacetime patterns, however it must be kept in mind, that in this statement the notion "are" is not meant as definition, as is the case in the statement "material objects are spacetime patterns".

Therefore, the second substance can be defined by the concept pair [spacetime, sensation]:

Mental substance := [spacetime, sensation]

Here, the transformation of the essence of being appears as transformation of the metaphysical quality: *activity* turns into *sensation*. The first substance is that, which makes the accidents of matter *active*, the second substance is that, which makes the accidents of the mind *active*.

It is readily apparent that *sensation* does exactly that: meaning without *sensation* is indifferent. *Sensation* is the basis of any assessment and any motivation. It is what drives us.

Third approach

In order to understand the cosmic evolution within the scheme of substance and accidents, it is necessary to determine the relationship between derivability and non-derivability on the one hand and essence-equality and essence-transformation on the other hand.

First, an outline for an overview:

¹⁵³ I point out once again that *activity* is not an accident. If we divide the *origin of everything* into substance and accident, in order to make it accessible to our thinking, and denominate it as activity of AGENT, then now *activity* appears indeed as accident, but from this follows that the difference between the accident "activity" and the metaphysical quality *activity* is shifted into the concept of the substance. Then, substance is what makes the accidents *active*.

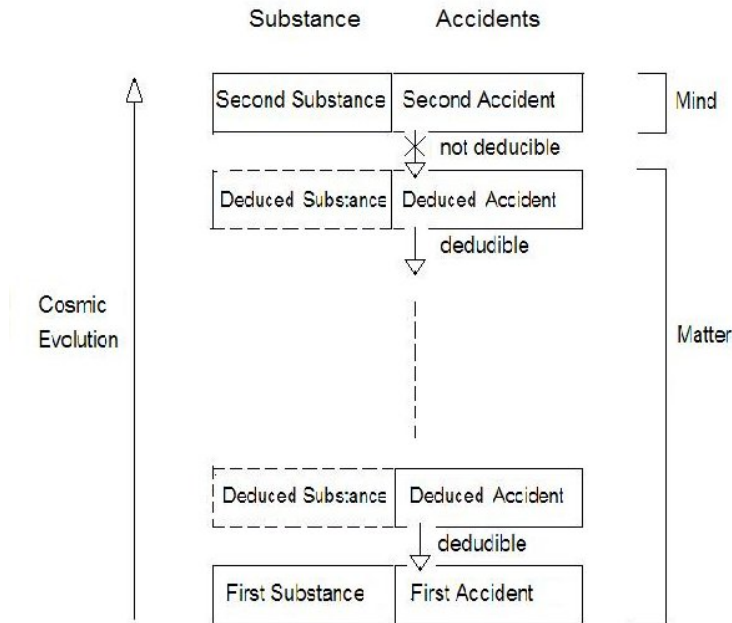

In this outline, only the right side is accessible to us, that is: the side of the accidents. The left side is about what in all descriptions is missing and cannot be thought: about the substance.

Therefore, *for us* the relationship between any layer of reality and the respective underlying layer is given exclusively through the alternative *derivable* or *not derivable*, that is: through the relationship of the accidents.

Derivability, however, is such a close relationship between that which is derived and that from which it is derived, that *for us* it seems as if the derivative and the original were *actually* the same. But this identity applies only to descriptions. In the reality, any accident is inseparably bound to an associated substance, and in the area of the substance there is no derivability. The notion *deduced substance* can only be understood as defined in 5.4 under Note 4: as substance that is associated with a deduced accident.

Being is always accident *and* substance. If now the concept of derivability is not admissible in the area of the substance, then, at the same time, the idea is canceled that being, whose accidents are derivable,

is a derivable being. The identity between that which is derived and that from which it is derived cannot be transferred to reality. It proves to be a deception, which only *for us* exists, and to which we succumb when we equate reality and description in the same way as it is done in present science.

Reality and description differ from each other, and, in the same way, also evolution and derivation are different. So it would be quite appropriate to assume that the essence of being is changing in each evolutionary step to a more complex layer of being.

However it remains true, that *for us* the substance does not change as long as the accidents are derivable, and that it appears transformed only if the accidents are not derivable. Therefore it is justified to divide reality into a material and a mental area.

Fourth approach

Finally, to some extent it is also possible to reconstruct the concept of the mental substance directly. As follows:

A concept of the substance of a mental state is needed, which does not relate to the physical or to any other layer *below* the mental layer, but which proves to belong to the mental state itself and which appears appropriate to provide the accidents of the mental states – the intrinsic meanings – with *activity*.

Of course we already know which concept is suitable: *sensation*. But the question is how far the substance SENSATION can be conceptualized, in other words: how far could we understand SENSATION – so to speak – *from outside*, if we would not know it *from inside*, from our own experience.

So let us then imagine, we knew everything about neuronal networks, but we did not know what SENSATION is, and our task would be to figure out what the substance of mental states is. How far would we come?

We have to start on the side of the accidents. What do we find? Intrinsic meanings. They follow one another in time and are networked together in a virtual space. (I avoid the expression state space because I think that the ever-changing dynamics of the interconnected meanings cannot be transferred to a state space. There is no lawful relationship between the physico-chemical and neuronal parameters on the one side and the permanently altered meanings of the patterns on the other side, because in this scenario local and global laws complement each other in a not-formalizable way. More on that later.)

The question is: what provides the meanings with *activity*? The answer must be a concept that belongs to the same layer as meaning, a concept which forms a pair with the concept meaning in the same way as the concept mass forms a pair with the concept gravity.

In considering the question: "in which systems can occur feelings?" we have stated that there must be *someone who* feels. The same applies to meanings: speaking of meanings only makes sense if there is someone *to whom* they mean something.

With this, on the side of the accidents we have the following preconditions:

The accidents of mental states are meanings. What they mean, is meant *for a subject*. To this subject, they must be given directly and as a whole, not in the form of sets of values of variables.

How could a substance-concept be constituted, which is appropriate to form a pair with this accident-concept – an inseparable unity like mass and gravitation?

What we already know is that in any neuronal network, which belongs to a viable living creature, there is a system that *assesses* neuronal states. From this system, the regulation of the dynamics of the global neuronal states must have emerged, before they turned into mental states and regulated their dynamics themselves.

For the subject, the assessments must be given as directly as the meanings, that is: again not in the form of sets of values of variables, but in the form of *qualities*.

What is a *quality for a subject*?

If we would not already know the sought concept, then we would define it precisely as *such*: as "quality for a subject".

Quality for a subject is appropriate for forming an inseparable unity with the accident *meaning for a subject*.

Quality for a subject is the substance of the mental being.

I think with this the maximum possible conceptual approach to the ultimately inconceivable substance SENSATION is realized.

5.8. *Philosophical Zombies*

"Philosophical zombies" are hypothetical beings devised for the purpose of illustrating the question of the relationship between neuronal states and qualia and thus also the problem of distinguishing between machines and sentient beings.

The physiology of philosophical zombies resembles that of humans. Zombies have therefore the same brains as humans. But they lack sensation. They do not experience qualia.

Is it possible that such zombies exist?

From our point of view can be seen immediately that their existence is impossible:

The condition that a zombie brain is identical in physiological respect to that of a human includes the identity of structures *and* processes. This means that in the zombie brain the neuronal states are networked with each other and also being changed by interaction in the same manner as the states of a human brain.

From this follows, however, that the process of transformation from a *physical being* into a *quale* must have taken place.

Therefore the neuronal states – the spatio-temporal excitation patterns – of the zombie brain are also qualia.

If it were assumed the zombie had no sensation and the neuronal patterns of the zombie brain were *nothing but* information processing, then this would be as absurd as the assumption that the Earth could exist without gravity. It would mean to remove from being its substance, i.e. that which provides the accidents with the metaphysical quality *activity*. But substance and accidents are always inseparable, they are always *one*. In the case of the earth, this seems obvious to us; in the case of the qualia, however, such absurd conceptual constructions as "neuro-zombies" seem possible – but only as long as one has no concept of what qualia are.

If a neuronal excitation pattern, which has become a quale, could be *removed from the network of meanings*, which it owes its existence to, then it would actually be *nothing but* a neuronal pattern. *As mental being*, it would then be destroyed, it would have turned back into a physical being.

But it is clear that a *global* neuronal excitation pattern cannot be separated from its neuronal environment without also changing it physically. Perhaps the structure could be conserved for a short time, but not the dynamics. It would instantly – starting at the moment of separation – change and, after a short time, break down.

5.9. Artificial Intelligence

Understanding

Can a machine that converts character strings into other character strings according to certain rules *understand* something?

This question can be answered with amazing clarity through a thought experiment by John Searle that bears the name "Chinese Room". The following abbreviated version was formulated by Searle in 1999:¹⁵⁴

"Imagine a native English speaker who knows no Chinese locked in a room full of boxes of Chinese symbols (a data base) together with a book of instructions for manipulating the symbols (the program). Imagine that people outside the room send in other Chinese symbols which, unknown to the person in the room, are questions in Chinese (the input). And imagine that by following the instructions in the program the man in the room is able to pass out Chinese symbols which are correct answers to the questions (the output). The program enables the person in the room to pass the Turing Test¹⁵⁵ for understanding Chinese but he does not understand a word of Chinese."

If one accepts that this procedure is possible – and one is forced to do so, if one considers *artificial understanding* possible – then this is a valid argument against the Turing test. Indeed, the Chinese Room *is* a version of the Turing Test: Although here the unknown communication partner is a human, he still does not understand Chinese. However, as he passes the test, the ability to understand Chinese must be attributed to him.

¹⁵⁴ John Searle, *The Chinese Room*, in R.A. Wilson and F. Keil (eds.), *The MIT Encyclopedia of the Cognitive Sciences*, Cambridge, MA: MIT Press, 1999.

¹⁵⁵ In this test, which is named after its inventor Alan Turing, people must realize by written communication with an invisible partner whether that partner is a computer or a human. If a decision is not possible, to the partner human abilities will be assigned.

Searle then adds: "The point of the argument is this: if the man in the room does not understand Chinese on the basis of implementing the appropriate program for understanding Chinese then neither does any other digital computer solely on that basis because no computer, qua computer, has anything the man does not have."

In this form, however, the argument is not correct: If the Chinese Room is regarded as computer analogy, then the man represents obviously not the whole computer, but takes over only the tasks of data transport and data transformation. Even the toughest defenders of the existence of artificial intelligence, however, would hardly claim that processor and motherboard alone could understand something.

Therefore, it was argued against Searle¹⁵⁶, that not *the man*, but *the system* understands Chinese.

Searle countered with the argument that the man could learn the data and the program, and then he would *be* the system.

I break the discussion of the thought experiment at this point, because I am convinced that the latter variant provides the proof that computers do not understand what they are doing:

The actions of the man correspond exactly to those of a computer – he transforms character strings into other character strings according to predefined rules¹⁵⁷ – and he does *not* understand, what the strings mean.

Any doubts that the thought experiment would be feasible at all, are not directed against the argument, but in any case only against the assumption that understanding can be simulated. The strength of the argument lies precisely in the fact that the maximum, which is achievable in a simulation, is presupposed: it is assumed that the answers, which the man writes down without understanding them, cannot be discriminated from the answers of a man who understands what he writes.

This means: Even if artificial intelligence had reached its goal, to simulate communication in such a way that it could not be discriminated from human communication, the simulation would lack understanding.

¹⁵⁶ Among others, by Georges Rey: *What's Really Going on in Searle's "Chinese Room"*, Philosophical Studies 50, 169–185. 1986.

¹⁵⁷ In order to take into account also the possibility of a learning program one can simply add that the man transforms also the strings of the rules in his "book of instructions", depending on the respective input.

Another strength of the thought experiment is that it provides a simple and intuitive discrimination between understanding and not-understanding: you can talk with the man in English *and* in Chinese. He understands English, he does not understand Chinese. Understanding is that by which the two activities differ from one another. Each of us knows this difference. We *understand* it.

Thus Searles argument proves that even a perfectly successful computer simulation of human communication lacks understanding of *what* is simulated.

The argument, however, provides no answer to the question of why this difference exists between humans and computers. And particularly because of the clarity, with which the lack of understanding is displayed in Searle's thought experiment, the explanation of this matter appears urgent and long overdue.

Why Computers cannot bring forth Mind; the *formal* Reason

In chapters 3, 4 and 5, mind was defined in a scientific manner, its existence justified by scientific methods and the transformation of the essence of the physical being into a quale explained by metaphysical arguments.

So the answer to why computers do not understand what they are doing must be contained in the conclusions of this chapters. This will now be demonstrated.

First we clarify a question that arises immediately: *When humans communicate verbally, are they then not also machines transforming strings according to certain rules?*

The answer is *no*. In Chapter 3. *Free Will* was shown that mental activity does not follow fixed rules or rules that vary according to fixed meta-rules.

(In Chapter 4. *The modified Picture of Reality*, I substantiated that this claim does not contradict the assumption that it is determined everywhere and anytime by the fundamental law, how the future emerges from the present.)

The following thought experiment is meant to serve for highlighting precisely *that* difference between humans and computers, from which follows why computer simulations of mental performances do not contain understanding.

Let M be a human neuronal network. The combination of all variable values of M at a given time point is a *state* of M .

We look at a sequence of states of M in a time interval Δt , which begins at $t = 0$ seconds and ends at, say, $t = 1000$ seconds. We call this sequence D .

The duration of the time steps between two consecutive states can be chosen at will. We assume their length as 10^{-24} seconds. Thus the sequence D contains 10^{27} states of M . (Since this is a thought experiment, however, the duration of the time steps can be further reduced.)

We specify that the variable values are represented with a precision of 1024 bits. (Also this accuracy can of course be assumed as desired.)¹⁵⁸

As a prerequisite for the following argument, the conclusions are needed, which were developed in the chapter on free will. Here's a short summary:

The neuronal network is made of several superimposed layers of increasing complexity, each of which consists of entities that interact with each other. Therefore, the natural laws are not sufficient for the description of the dynamics of the network. Further laws – so-called laws of structure – must be factored in.

The laws of the hierarchically highest layer, that is: the mental laws, are dominant, which means that the dynamics of the mental states determines the neuronal and molecular dynamics to a greater extent than the reverse is the case (In the 4th chapter, this fact was denoted as *causality top-down*.)

The laws of the mind, however, in contrast to the laws of the other layers, are not fixed. The mental activity acts back on itself: it changes its own neuronal encoding and, with this, also the network of meanings, and from this follows at the same time a change of the transition rules of the sequences of mental states.

Now we introduce the following Turing machine into our considerations:

¹⁵⁸ The reason for the introduction of D is that D can directly be compared with a computer or a Turing machine.

(I will not give here a definition of a Turing machine. To understand the following, it is sufficient to know that a Turing machine can calculate everything which any arbitrary computer can calculate.)

Let T be the Turing machine that *exactly* reproduces the state sequence D within the time interval $\Delta t/2$ which starts at $t = 0$ seconds and ends at $t = 500$ seconds.¹⁵⁹ (The existence of T can be presupposed.)

Thus, within the interval $\Delta t/2$, the states of T are identical with the states of M (according to the chosen approximation).

The dynamics of T is computable. Therefore a function – say f_T – exists which permits calculating the whole sequence of states of T within the interval Δt from the initial state of T – this is the initial sequence of the characters 0 and 1 on the tape of T, which represents the state of M at the beginning of the interval Δt .¹⁶⁰

Our first question is: *What happens after the end of the interval $\Delta t/2$?*

The answer follows from the difference between M and T:

According to our presuppositions, the network M produces out of itself – in feedback loops – new rules of the transitions from one state to the subsequent state. Therefore, what happens *after the end of $\Delta t/2$* is not contained in the rules applicable *until then*.

In contrast, the rules of T are fixed. The Turing machine T is bound to the previously determined rules.

From this follows, that after the end of $\Delta t/2$ – if we let the Turing machine T continue to run – the states of T will no longer correspond to the states of M that are contained in D. Rather from this moment on an increasing difference must occur between the states of M and T.

Let us now again turn to the problem of the simulation of understanding. It has now assumed a clearer form:

¹⁵⁹ Each state of M which is simulated by T is a sequence of the characters 0 and 1 on the tape of T. I shall call such a character sequence – if it represents one of the states of D – a *state* of T, and that, what usually is called "state" of the Turing machine, I shall call *internal state*.

¹⁶⁰ Here, the question could arise, why not – instead of the function f_T – digitalized versions of the natural laws are used for calculating the state sequence of T. However that is impossible, because the non-linear feedback prevents calculating *exactly* any later states of M through initial conditions and such laws. (I remind you of the comparison with a great number of gravitating bodies: there is no exact procedure for calculating the future from law and initial conditions.)

The system M brings forth mind, M understands what happens. However, the sequence of states of the system T is – in any desired approximation – identical with the sequence of states of M in the time period $\Delta t/2$. Thus T is a perfect simulation of M, which can reproduce the states of M – e.g. also the states that control the speech output – during this period.

Does this mean that also T understands something in this time interval?

At first, the following must be cleared up:

What does the identity of the states of the two systems M and T actually mean? Is T just a digitalized version of M? Are M and T – in this sense – identical except for the different physical realization?

If this were the case, then to the Turing machine would have to be assigned understanding, which, however, we have excluded previously (in the discussion of the Chinese Room).

Moreover, this assumption would contradict the fact that, after the end of $\Delta t/2$, the states of M and T differ increasingly. If T were just a digitalized version of M, then M and T would continue to correspond with each other.

Therefore, though the states of M and T are identical within $\Delta t/2$, T is still not just a digitalized version of M.

However, "state" is defined as the set of *all* variable values of the system at a given point in time. From this follows that the structural difference between M and T must be attributed to the *transition rules*, which apply to the state sequences of the two systems.

What do we actually know about *this* difference between M and T?

In M, there are several layers of interacting entities. All layers have their own dynamics, and between all layers there is a complex interdependence. In different situations, the dynamics of a certain layer can take the leadership: e.g. in reflex actions the dynamics of the neuronal layer, in the case of defects of the transmitter system the dynamics of the chemical layer. Of interest to us, however, is the dynamics of the attractors of the network, which we have identified as mental states.

By contrast, in T the sequence of states is generated step by step, one character after the other, by the operation [read, write, move tape, change internal state].

With this, we have arrived at the precise formulation of the question of whether computers can simulate *understanding*. It reads as follows:

Can the dynamics of a neuronal network, which is based on the interaction of the attractors of the network, be simulated by transformations of values of variables which are performed step-by step and according to given rules?

As expected, the answer is *no*. The reason is that the description of the formation and alteration of order is performed through *global variables*, and that this description, as was shown in chapter 4, cannot be reduced to the description through *local variables*. The same, however, is also true vice versa. The relationship of the two kinds of description is *not formalizable*.

As mentioned, the mental activity acts back on its own neuronal encoding, which in turn affects the mental activity. This means; the dynamics of the global variables changes the dynamics of the local variables and vice versa.

If the Turing machine T is supposed to produce a complete simulation of the human neuronal network M – in other words, if M and T should indeed be isomorphic –, then T must reconstruct both the global and the local dynamics. This, however, is impossible, because, though both are interconnected, this interconnection can still not be expressed by an algorithm. But if they are reconstructed separately, each on its own, then the reconstruction fails, because the effects of the other dynamics are not factored in.

Thus, the interaction of attractors cannot be simulated through a step-by-step calculation of variable values, as it is the case in Turing machines. In order to generate the according state dynamics, the attractors – the mental states – must be present *as such*. In other words, only the neuronal activity patterns *as a whole* can produce the dynamics of the neuronal network. Their existence is a necessary condition of this dynamics.

But in a Turing machine or in a computer, they *have* no existence. And this holds true regardless of the possibility of parallel processing or the assumption of multi-layered hierarchical program structures.

Regardless of how complex (future) computer simulations of mental performances might be, how many levels of meta-representations they may contain or how many processors work in parallel – there remains the unalterable fact that all changes take place step by step and separated from each other and can therefore never form a *whole autonomous entity*.

And this means that the dynamics of mental processes – i.e. the dynamics of the attractors of the network – cannot be reconstructed by a computer.

I summarize: The attractors do not exist in a computer. Their simulation is not possible, because the dynamics of their interactions represents an *autonomous element* of reality and its description and cannot be reduced to the dynamics of local entities. Therefore, the interdependence of the dynamics of the local entities (the neurons), and the global entities (the attractors, that is: the mental states) cannot be mapped to a sequence of transformations of variables.

Ultimately, this argument means that a mental state is *an indivisible being*. Mental states are unities of *meaning and SENSATION*. As such, they are indivisible and can only interact with each other *as a whole*, and this precondition is transferred to their physical form, to the neuronal excitation pattern, the attractor, which is the necessary condition for the existence of the mental state.

With this, it is also cleared up, why M and T are not isomorphic. The entities, by which the dynamics of M is *actually* determined, do not at all exist in T, neither as they themselves nor in a simulated form. Thus also the transition rules of M cannot exist in T.

Therefore, even if the transition rules of T permit a complete and arbitrarily precise simulation of the states of M in a given time period, it is still true that these rules do not contain the *causal connections*, that is: those relationships which the development of the actually existing system M *in fact* depends upon, like e.g. *reasons*.

From this follows that the dynamics of a system must not be equated with a function, by which a state sequence of the system in a given period can be calculated. Between the two there is an inescapable ontological difference.

So this is the reason why, on the one hand, in T an algorithm can be implemented that generates a sequence of states which correspond to the states of M within a given time period, and why, on the other hand, this algorithm does not apply beyond this time period: The structure of the state space of the neuronal network M is determined by the mental states and their relationships, and this structure cannot be reproduced by an algorithm, because the relationships of mental states are not formalizable at all.

This statement is also the first step of the substantiation of the metaphysical assertion that T does not understand what happens.

The second step is the following statement, which has been derived in sections 5.3 and 5.4 of this chapter:

The transformation of physical states – neuronal patterns, which are attractors of the global neuronal dynamics and represent something – into qualia can only occur, if these patterns themselves are again networked with each other to such a high degree that their information content is determined by this internal networking and cannot be regarded as function of other – inner or outer – circumstances.

However, if this ever-changing network of attractors does not exist in a computer, because its dynamics cannot be simulated by transformation of variables, then from this follows that a computer cannot produce mind. Its states are not qualia. Its dynamics remains pure information processing and will never turn into mind.

Understanding, however, is a mental process. Therefore, computers cannot understand.

Still, it remains open how far it is possible to reconstruct mental performances by (mindless) simulations. The realm of possibility, however, seems to be, in almost all cases, much smaller than the extent of the hopes – only rarely the initial optimism proves to be true beyond the initial stages of implementation. As soon as leaving limited formalizable sub-worlds, the performance of the simulations usually decreases to an unacceptable level.

At last the question remains, whether at all there can be mind, which has not evolved naturally but is created by us. Thus the question is not about the possibility of artificial *intelligence* but about artificial *mind*.

I see no reason *on principle* to exclude the existence of a mind created by us.¹⁶¹ At present, however, it is unclear how a system that brings forth mind can be realized other than biologically.

In addition, it can hardly be estimated how much evolutionary know-how – which would have to be technically implemented in the production of artificial mind – has entered into the chemistry and structure of a human neuronal network and the body that belongs to it.

It is very likely, however, that it is much more than currently assumed by those who are considering the optimization of humans.

¹⁶¹ A fundamental restriction, however, will follow in the next section 5.10. *The metaphysical Difference between Reality and Simulation.*

Note:

Ultimately, all formal and technical arguments, why the dynamics of natural systems cannot be simulated exactly, are based upon the fact that nature is not an algorithmic system: it produces the future from the present not through the application of an algorithm, but alone through the differential conditions given at any point.

As discussed in chapter four, the way in which nature generates the future cannot be transferred to a description or to a model. For this reason, an exact and complete description or modeling of reality is impossible.

This represents an insuperable limit for simulations.

In those areas of reality, where nature approaches algorithmic describability through the formation of order and the according laws of structure, this limit is irrelevant. A known example is atomic and molecular processes. Here, in some cases a description is possible which does not differ measurably from reality.

But there are also areas, which elude describability.

And in the case of mind, exactly that what should have been simulated will be lost.

Why Computers cannot bring forth Mind; the *metaphysical* Reason

The metaphysical explanation, why computers cannot produce qualia, is much shorter than the formal explanation:

States of computers are strings of the characters 0 and 1. Thus, a computer state is a *number*, and the dynamics of a computer is a sequence of transformations of numbers.

A necessary condition for the transformation of a physical state into a quale is that its accidents cannot be understood as functions of simpler accidents or as functions of outer or inner (non-mental) circumstances. Only then the second substance SENSATION can emerge.

This statement must be adapted to the conditions in the computer.

The accidents represent what constitutes the dynamics of the system. In the case of a computer, this is the program or the transformation rules. If the program is capable of learning, then the transformation rules change. In any case, however, there are no "simpler" rules but only "earlier" ones.

With this, the necessary condition for the occurrence of qualia in a computer can be formulated:

The transformation rules must not be functions of earlier transformation rules, earlier states and the current input.

But any state of the computer is a function of the input, the previous state and the transformation rules applied to it, and the same is true for any set of transformation rules. There is a chain of functional dependencies, which is never interrupted and leads back to the initial state and the initial program.

And from this follows that the transformation into a quale never happens.

There is no *mind in the machine*.

5.10. The metaphysical Difference between Reality and Simulation

All previous arguments about the limitations of our simulations were at least partially formal.

However there is also a purely metaphysical argument, which is based on the difference between reality and simulation and from which a fundamental barrier for simulations can be derived.

It reads as follows:

Reality consists of *substance and accidents*. Substance is that, from which the effects of a being emanate, and at the same time that, which provides the accidents with the metaphysical quality *activity*.

From an actually existing system, however, *only the accidents* can be transferred to a description or a model of the system. For this reason, the descriptions and models lack this activity; *by themselves*, or *out of themselves*, they are *passive*. They consist only of accidents.

A simulation, however, is nothing other than a model of reality, which is *activated* in some way. Thus, also a simulation is not active *by itself* but needs activation from outside.

For illustration, let us consider the system Sun, Earth and Moon:

A model can be produced, a so-called *tellurion*. Through suitable mechanical devices (gears, shafts, chains etc.), the movement of earth and moon can approximately be imitated – however only if the model is provided with *activity* from outside, e.g. by a crank or an electric motor. *By itself*, it is *passive*.

The movements of the bodies can also be calculated in a computer and then projected onto a 3D-screen. But also the model, which is implemented in the computer in the form of initial conditions and equations and the according numerical approximations of solutions, is *passive*. Only if the power is turned on, the simulation begins to run.

Thus we define:

A simulation is the reconstruction of the dynamics of a system A in another System B, which differs from A in the following way:

The dynamics of A results from the substance and the accidents of the objects in A, which means: the objects in A are active by themselves and according to their essence, and, in this way, produce the dynamics of A.

The dynamics of B, however, does not accrue from the substance and the accidents of the objects in B, but from the construction of B, which is designed and implemented by us.

Metaphysically spoken: the objects of B serve only as material basis of constructed accidents which, accordingly, have no associated substance. Since these accidents lack the substance, they are not active out of themselves. Thus the system B needs to be provided with activity from outside.

This definition can again be illustrated using the example of the tellurion:

In the real system sun, earth and moon, the objects move *by themselves* and according to their essence, that is: through their gravitation.

In the simulation, however, the activity according to the essence of the model bodies is indeed present – as gravity which manifests itself through the weight of the bodies –, but it contributes nothing to the dynamics of the simulation. For that, the design of the tellurion – just the gears, shafts, chains etc. – is responsible, which *we* have created. And the simulation is not moving *by itself*, but only if it is driven. Only then, the model bodies imitate the movements of the celestial bodies.

From the just defined difference between reality and simulation follows the important

Proposition

In the simulation of a being, the essence of this being is lost.

A tellurion imitates the movements of the celestial bodies, but *not through gravitation*. The metaphysical unity of the substance *mass* and the associated accident *gravitation* – the essence of the beings in the actually existing system – disappears in the simulation. Here, the movement is the result of constructed, *mass-less* accidents.

A computer program can imitate mental performances, but *not through mind*. The metaphysical unity of the substance *SENSATION* and the accident *meaning* – the *quale* in the actually existing neuronal network – disappears in the case of the computer. The imitation takes place through constructed, *sensation-less* accidents.

So if we aim at creating a system that brings forth mind, this system cannot be a *simulation* of mind.

To say it even more clearly:

There is no simulation of mind, because in the simulation the essence of being is lost. From the quale, whose essence is the unity of SENSATION and meaning, in the simulation remains only the meaning, i.e. the information content.

Through the layer of the constructed accidents, the metaphysical unity of substance and accidents – which is not contained in any description – is abolished, and upon the dynamics of the reality, which *as such* cannot be captured completely, an algorithm is imposed, a layer of reality that consists *only of accidents*. Here, there is no room for the substance SENSATION.

In the case of gravity, the fact of the disappearance of the substance seems self-evident:

Regardless of how perfect the connection between the objects may be constructed, which are supposed to imitate the gravitational dynamics – what drives them *is not* the (deduced) substance *mass*. The cause of their dynamics is not gravitation, and it can also never turn into gravitation. The simulation does not contain gravitation.

In the case of mind, the same applies:

Regardless of how precise the simulation is – what drives the entities of the simulation *is not* the substance SENSATION, and it can also never turn into SENSATION. The simulation does not contain *sensation*. It does not contain *mind*.

Corollary

The simulation of mind is impossible.

In the evolutionary development of nature, the metaphysical quality *activity* is transferred from any layer of being to the next-higher, more complex one. At the last step, mind emerges through the transformation of the first substance into the second substance.

But this transformation of the substance occurs only *for us*. *In themselves*, substance and accidents are *inseparable* in any layer of being, and they evolve *as unity*.

In a simulation, the accidents, by which the dynamics is formed, are substance-less. But in order to bring forth mind, it would be necessary that there is a substance that belongs to this accidents and could then turn into SENSATION. This substance, however, cannot simply "emerge". Thus, a necessary condition for the transformation is that the substance to be transformed is already there.

But the substance which *in fact* is present there – the one of the elements of the simulation – is not the substance that belongs to the accidents which form the dynamics of the simulation, and therefore it cannot turn into SENSATION and be transformed together with its accidents into a *quale*.

Thus, the simulation cannot bring forth sensations, in other words: *it does not feel anything*.

Sensation is not an accident, i.e. not an attribute of the system or of its elements. It cannot be *constructed* but must result from the activity of being according to its essence.

This means: For the creation of mind, it is necessary to avoid the layer of substance-less, constructed accidents. The objects, whose dynamics is supposed to lead to the emergence of mind, must act according to their essence, that is: through their own accidents and through the activity that is provided by their associated substance.

It is therefore impossible, to generate mind on the basis of silicon or other materials with similar attributes. Mind can be created by us only in the form of an "artificial evolution". Thus the creation of mind is shifted into a far distant, perhaps unreachable future.

Addendum

The hope that someday in the future computers might be able to feel something is based on the confusion of an *actually existing system* with the *time-dependent evolution of its state*.¹⁶²

This confusion becomes apparent already in the term itself: in everyday language, the term "state" relates to something that exists. The physical "state" of a system, however, is just a string of numbers – the values of the system variables –, and a computer simulation is the successive transformation of this numbers. It is irrelevant how the numbers are encoded and which storage medium is used. And it is equally irrelevant how the transformation is performed and in what kind of machine it takes place. In

¹⁶² As a reminder: The *state* of a physical system is the combination of all variable values of the system at a given point in time.

any case, it is still a *sequence of states*, which means: a list of numbers which change with time, and it will never be identical with the *actually existing system*.

The definition of a simulation as dynamics of constructed accidents without substance, which has been presented in this section, is concretized and illustrated by this image of a computer simulation. Here it becomes understandable, what *constructed, substance-less accidents* are, which need a material basis, and what it means, on the contrary, that the actually existing system develops due to the *activity* of its elements *according to their essence*, which emerges from the *inseparable unity of substance and accidents*:

In the simulation, the values of the variables are stored on a material basis. They are transported to a calculating unit, re-calculated and then transported back to serve as output for one image (frame) of the simulation. Here, the variables do not stand for the accidents of the storage medium or the calculating unit – they can be separated from them and form with them only a temporary combination for the sole purpose of the simulation. Thus, calculating unit and storage medium do not represent the substance that belongs to these variables, but only their material basis. A material basis, however, cannot turn into SENSATION – this can only occur with a substance that is inseparably bound to accidents from which more complex, non-derivable accidents emerge.

The actually existing system is not just a list of numbers that changes with time. In the real system, there are no numbers, which can be written into a memory, transformed and be removed, but *attributes of things*, which are inseparably bound to these things and from which the dynamics of the system unfolds. In the case of human neuronal networks, this leads to the development of non-derivable accidents and to the transformation of the according substance and, with it, to the emergence of mind.

Existence is more than a *sequence of strings with transformation rules*. Presumably, (almost) any human being knows that intuitively. If the confusion of reality and description were not already so far advanced, then the idea of the computer simulation could actually serve as paradigm for the insensitiveness of simulations, because it is so obvious that the totality of the acts of calculation and storage of variables can never produce a sensation or a feeling.

However as long as one has no concept of this intuitively evident fact, it is ultimately *unjustifiable*. Hitherto, exactly that has been the case, and this lack of conceptualization resulted in the unclearness and confusion regarding the question of whether simulations can feel and understand.

Clarity is achieved only through the conceptual determination and analysis of the difference between reality and simulation, which has been carried out here. From this difference follows that computers

are not capable of feelings and that they will never bring forth mind, regardless to which extent their performance can be enhanced.

At last a note about artificial neuronal networks. If they are realized on conventional computers through *software*, then everything just said holds true. But what about artificial networks that are already constructed as such, that is: which are realized through *hardware*? Can they break through the previously determined boundary for simulations? Are they capable of producing mind?

No. Also in this case, our metaphysical argument holds true. Whenever the elements of a system are *constructed by us*, a layer of *substance-less accidents* is created. Thus, the substance is lacking which could turn into the second substance SENSATION. The emergence of sensation and mind does not take place.

This is a purely metaphysical argument. Can it be interpreted also *formally*? I think *yes*:

Reality is not determined, the future is not contained in the present. For this reason, *causality top-down* exists, and this means, that through self-organization complex, autonomous entities can evolve, which form a new layer of reality, with a dynamics of its own that is not derivable from any layer that lies below. Therefore, these complex entities can be regarded as *causes* of what happens – just as is the case with *mental states*.

In contrast, in a system constructed by us, the dynamics is always determined through *causality bottom-up*. The temporal development of the system states is completely determined by rules. Complex entities do not form a new, autonomous layer of the system. Their dynamics is determined by the dynamics that *we* constructed. *Mind* as autonomous phenomenon cannot develop. It is not possible to *construct* mind.¹⁶³

The transition from an actually existing system to a simulation, i.e. to a constructed system, is tantamount to a *depletion* of the system. The richness of the possibilities of shape formation that lies in the *essence of the reality* – that is to be substance *and* accident – disappears in the construction. It consists *only of accidents*, such that it lacks the metaphysical quality *activity*, and this means that a construction – as well as a description – cannot imitate the way in which reality generates the future.

The fabric of reality is of infinite subtlety. It cannot be replicated by our constructions.

¹⁶³This remains true if the construction is non-algorithmic. Even then, the emergence of mind is ruled out through the metaphysical argumentation. The metaphysical argument is therefore stronger than the formal one.

6. Reality and Mathematics

With the conclusion of the chapter on qualia, the project of this book is completed: to develop a concept of reality, which permits to treat "what is" and "why" questions not only formally but to follow them up to their metaphysical ground and from there to give the correct answers, and which makes it possible to think reality closed in itself and complete, including all phenomena that belong to it.

However, there is still something to be done: in 1.4, I have announced an explanation of why mathematics and logic do not exist "outside" the universe, but emerge from this universe and are part of it. This is the subject of this chapter.

6.1. Introduction: The Connection between Reality and Mathematics

What is mathematics? The science of relations between objects and the structures evolving thereof.

What is reality *for us*? Relations between objects and the structures evolving thereof.

With this, most directly a close connection between mathematics and reality becomes apparent, which however only at first glance appears as possible identity of reality and a corresponding mathematical structure, because already the next intellectual step proves – as elucidated at the beginning of the Second Part – that there is an insurmountable difference between reality and its descriptions:

The objects of reality *exist*, whereas the objects of descriptions are only *defined*. Therefore mathematics lacks – as well as any other description system – the *substance* and, accordingly, the metaphysical quality *activity*.

However this does not mean that the just determined close connection between mathematics and reality is canceled. It only means that reality can never be identical with a mathematical structure, and that the necessary remaining difference is of a metaphysical kind.

But even if this difference is a metaphysical one, it must still manifest itself also formally: if it remained formally invisible, then *for us* the difference between mathematics and reality would be without consequence, and then it would not make sense to claim such a difference.

How the difference between mathematics and reality manifests itself as limitation of the formal describability of real systems has been one of the subjects of the previous chapters. Here is a short summary:

Every mathematical system consists of *a given set of axioms and rules*.

By contrast, the reality – due to its metaphysical quality *activity* – permanently produces *new rules* that cannot be derived from the given ones. So if one tries to map the reality onto a mathematical system, then the reality will incessantly produce states, which – expressed as propositions of the system – correspond to Gödel propositions, i.e. to non-derivable propositions.

This means: *the reality transcends every possible mathematical system*.

However, we know that many areas of the reality can be described by a mathematical system with great accuracy. Can we assume that we will – ultimately – find the best mathematical approximation? Or is it possible that the description of reality requires a mathematical structure which – given from where we have to start – is not accessible to us?

This seems unlikely. The kind of the connection between mathematics and physics on the one hand and reality on the other hand speaks against it: Mathematics begins with counting, and physics begins with measuring. Reality is countable and measurable, and in many cases the measuring values exhibit regularities. Why this is the case, has been elucidated in the initial chapter of the Third Part: Reality *emerges* from a law, it *is* the law – insofar the term *law* is understood not only formally but metaphysically, i.e. as *that which executes itself*. (On the question of countability, I'll be right back.)

In summary, it can be stated:

On the one hand, it is by no means mysterious or surprising why mathematics is suitable for the description of reality, but evident. On the other hand, there are also limitations, which, in the view of the reality presented here, ultimately go back to the fact that it is impossible to imitate through mathematical methods how reality generates the future, because it is performed in a non-algorithmic way, which presupposes the metaphysical quality *activity*.

Nonetheless, among all possible descriptions, mathematics is the one that represents the accidents of the objects of reality – i.e. the *structure* of the objective reality – most accurately, as long as the described entities and processes belong to the realm of *matter*.

Also the *origin of everything*, which *in itself* does not divide into substance and accident, can, as that what it is *for us* – as ever changing continuum –, be captured mathematically through the concept of the mathematical limit.

For an understanding of *mental phenomena*, however, a description which is adapted to the essence of the mind – the unity of SENSATION and meaning – is far more suitable. Here, mathematics and natural science have only assistive function; the attempt to capture mind in a scientific way reveals immediately the metaphysical shortcomings of mathematical and scientific concepts and methods.

6.2. Short Excursus: the three Worlds

I consider the division of the realm of the existing into the world of material objects (world 1), the world of the mind (world 2) and the world of intellectual products (world 3) right and necessary.¹⁶⁴

As long as it is a mere enumeration, however, it is unsatisfactory.¹⁶⁵

With the concepts developed here, it is easy to transform this list into a structural hypothesis about reality by answering the following questions:

- Which reasons compel us to divide the world in this way?
- How are the three worlds interconnected? How can worlds 2 and 3 act on world 1?
- How do the objects of different worlds differ from each other?

All three questions have already been answered here, however without having been mentioned explicitly.

In our terminology, world 1 is the world of the *first substance*, world 2 is the world of the *second substance*, and world 3 is the world *without substance*.

¹⁶⁴ Short and concise in: *Karl R. Popper: Three Worlds: The Tanner Lecture on Human Values at the University of Michigan, April 7th, 1978*

¹⁶⁵ Popper's arguments for this classification are not compelling, because all his statements can easily be transformed into reductionistic statements. They simply lack a *systematic* justification.

Is this not just another enumeration? Not at all! As a reminder, here is a quick recapitulation of the thought trains that contain the required answers:

The introduction of the concept *substance* is necessary in order to do justice to the obvious fact that objects of reality – as opposed to objects in a description – are *active*, and that this activity must come *from something* that does not appear as such in the descriptions.

This can be grasped conceptually through the statement that objects of reality consist of *substance and accidents*, whereas objects of descriptions consist *only of accidents*. They are substance-less.

In objects of the reality, substance and accidents are inextricably linked with one another. This follows immediately from the fact that it is impossible to deprive real objects of their *activity* – obviously it is impossible to separate the earth from its gravity.

Nature unfolds to ever more complex structures. As long as the more complex accidents can be described as functions of simpler accidents, these accidents remain connected through a chain of functional dependencies with the simplest accident – the first accident – and therefore also with the according substance – the first substance.

But the accidents of mental entities – intrinsic meanings – cannot be regarded as functions of simpler accidents. Therefore, their connection with the initially introduced substance is interrupted, and this enforces the introduction of another substance or of a transformed substance, with which the accident *intrinsic meaning* is inextricably linked.

This second substance must be exactly that, what descriptions of mental entities are lacking, and that is *sensation*. Through the emergence of mental beings, the first substance AGENT or SPACETIME transforms into the second substance SENSATION.

As can be seen, all these statements are direct consequences of the insight, which stood at the beginning: the insight that objects of reality are *active*, and that this activity must emanate *from something* or belong *to something*; thus, everything follows from the assumption of the *substance*.

The definitions of the three worlds, however, are already contained in these statements.

This means: The classification of the world into a material world, a mental world and a world of the products of the mind is a direct consequence of the (necessary) introduction of the substance. The connections between the three worlds as well as their differences are explained by the above conclusions in a simple manner.

Further important points are the following ones:

In order to justify the introduction of worlds 2 and 3, it is necessary to refute the hypothesis that mind can be reduced to matter. The according argumentation has been carried out in chapters 3. *Free Will* and 4. *The modified Picture of Reality*.

Moreover, the assertion that world 2 and world 3 can act causally on world 1, presupposes the concept of *causality top-down*. This concept has been introduced through examples and analogies in chapter 3 and justified systematically in chapter 4.

With this, everything of importance about the introduction of the three worlds and their interconnection has been said.

Regarding world 3 – the world of the products of the mind –, however, hitherto only some examples have been discussed. (One of these examples was *descriptions of reality*, another one, which has been described in more detail, was *simulations of actually existing systems*.)

Therefore now, before we come (in the next section) to the actual topic of this chapter – the question of the kind of existence of mathematical objects and propositions –, some general remarks on the entities of world 3 shall follow.

The main features of the entities in world 3 are exactly those which have been named in the section on simulation: The entities in world 3 differ from the entities of the other two worlds in that they have no substance and consist only of accidents. Therefore they cannot exist independently; they require a *material basis*.

These accidents can be mental or material. Examples of the first kind are books, compositions, or sanctuaries, examples of the second kind are apparatus, cars, or rockets.

Why have the entities in world 3 no substance? Because they lack *activity* or *sensation*. If they are constructed systems with their own dynamics, like a tellurion or any other technical device, they must be provided with *activity* from outside; if they *mean* something, like artworks or temples, then they enter the connection with the according substance SENSATION only if they are perceived and understood by an entity that possesses mind.

A necessary condition for a world 3 object is that it owes its existence to an *intention*.

Is this condition also sufficient? What about objects that have no dynamics, but merely fulfill a purpose, such as tables? Do they too belong to world 3?

This is a question of definition. But since the introduction of world 3 is inevitable and its existence is thus secured, it seems reasonable to class all objects that owe their existence to an intention under the objects of world 3.

6.3. Which Kind of Existence have mathematical Objects and Theorems?

Mathematics begins with counting.

The fact that the numbers, with which one counts, are called natural numbers, however, is misleading, because they are certainly not *natural*. There are no numbers in nature, or, more exactly: in world 1. *We* are the ones who count, in other words, numbers belong to descriptions of the material reality and not to the material reality itself.

If one considers the numbers with which to count as natural, then, after a series of steps that appear evident, one is faced with the imaginary unit, seeking in vain for its ontological status.

If, however, it is clear from the outset that there are no numbers in nature, then the difference between natural and complex numbers is only that the relationship of the natural numbers to elements of the physical reality is simpler than that of the complex numbers.

Numbers can appear in world 2 and in world 3:

- They can be elements of mental processes, in which they appear as mental entities or as accidents of mental entities.
- If they are elements of descriptions, which are attached in some way – e.g. printed – to a material basis using any kind of code, then they are entities of world 3.

World 1 does not contain numbers, but it is countable. Why is it countable?

The first prerequisite lies in us ourselves. As was shown in 3.4. *Organized States in Neuronal Networks*, we can neither think nor perceive the Individual, but only the General.¹⁶⁶

Natural numbers are such Generals, through which we perceive and think reality.

The second condition is that nature generates *objects* – stationary states of the continuum dynamics – which are sufficiently similar to each other to enable the formation of neuronal attractors that represent them, or, in other words, which fall under the same concept. Since at first the universe organizes itself *globally*, such that everywhere similar conditions for the local self-organization develop, this assumption seems plausible. Moreover, we can simply *see* that it applies.

Initially, the development of mathematics follows the path that is determined by the natural numbers and the well-known arithmetic operations. Thereafter, however, it turns into a free play of the mind with objects and structures, which is a characteristic of world 2.

Mathematics is the most outstanding example of a special kind of mental activity: the invention and elaboration of systems, which consist *firstly* of a number of defined objects, and *secondly* of rules how additional objects can be constructed from existing objects. These systems are then at the same time objects of world 3.

An example of such an entity is the carpet which was mentioned in section 4.3. *Why Nature is not an algorithmic System*. There stood the following: (I repeat the whole passage, because it illustrates the essential point of the question of what kind of existence mathematical objects and theorems have.)

"Suppose we have the intention to weave a multicolored carpet. The initial series of meshes lies already before us, and we also have a complete set of weaving-rules. Let us now assume that, at some point during the course of the weaving process, on the carpet the image of a lion arises.

The question is: did this lion already exist before the carpet was woven? If this means that the lion can be produced by the initial series of meshes and the weaving-rules – that, in this sense, it is thus contained in them – then the answer is *yes*.

¹⁶⁶ As a reminder: Patterns, which represent something, are attractors in the state space of the network. Attractors have a basin. Points in the basin correspond to stimuli that are triggered by an individual case, and the basin as a whole corresponds to all possible individual cases, which lead to the same attractor. The attractor itself is therefore the representation of the general over these individual cases. Thus, understood as a mental entity, it is not an Individual but a *Universal*.

Mathematicians are confronted with a question of the same kind, when they encounter mathematical theorems during the course of their conclusions. These theorems are obviously not invented but discovered. They are in the same way "contained" in the axioms and rules of the mathematical system, as the lion is contained in the initial series of meshes and the weaving-rules of the carpet system."

Therefore it is clear which kind of existence mathematical objects and theorems have: they are elements of systems, which are devised in world 2, i.e. by entities that possess mind.

If in the system a procedure exists, through which one can, after a finite number of steps, arrive at such an element, then it can be *discovered*, and therefore it seems justified to claim that this element has existed already before its discovery.

Thus, mathematical objects and theorems exist if and only if a system exists, according to whose axioms and rules they are formed. Through application of the rules for constructing new objects and propositions they can be discovered.

So the following can be asserted:

Mathematical entities are created in world 2 and exist then in world 3. Therefore, mind is a necessary condition for the existence of mathematical entities – as it is for all entities of world 3. In short: without mind no mathematics.

Some mathematicians and philosophers believe, however, that mathematical objects and statements have a Platonic existence, i.e. that they exist entirely independently, in the form of an autonomous reality.

The reason for this believe is that mathematical propositions seem to be true regardless of their material realization. The ratio of circumference and diameter of a circle will always be π – and one is tempted to say, no matter what universe one is in or even whether a universe exists.

So why is that the case? To investigate this issue, we first focus on the question of whether numbers and basic arithmetic operations are *invented* or *discovered*.

The answer follows from the just mentioned fact that the mind contains not individuals but only generals. Any object that appears in our perception or in our thinking is a *universal*. It can only be understood as individual by assigning to it a name, or a position and a point in time, or through a sufficient number of characteristics, which however, considered alone for themselves, are again universals.

From this follows that, for entities that possess mind, the world is divided into *sets*.

Numbers, however, are nothing other than properties of such sets. (E.g. the number 5 is that property which is common to all sets that contain exactly as many elements as I have fingers on one hand.) In other words: counting is a fundamental act of any sufficiently developed mind; therefore it appears *with necessity* in such a mind.

The next step: The elementary operations with numbers originate from experiences made through the handling of objects: 2 sheep plus 1 sheep equals 3 sheep, and this is a law that applies regardless of whether there are sheep, and even regardless of what is being counted, i.e. regardless of its material realization.

Does this law possess a platonic existence? No. It can only occur if the natural evolution has produced beings with mind, who understand the world conceptually and divide it therefore into sets of objects.

Did this law exist, *before* it appeared in the mind? No. Nothing exists before it emerges. Also mind does not exist, before it evolves, and this assertion would hold true even if it could be demonstrated that the evolution of mind *is necessary*, in the sense that every possible evolution of the cosmos must bring forth mind. Also in this case, it would not be reasonable to claim that the mind existed before it actually appeared.

The same applies to mathematical objects and theorems. They appear as necessary consequence of the relationship between mind and material reality. Only with the appearance of mind they can exist; before that, they have no existence.

Thus, the question of whether numbers and arithmetic operations are invented or discovered, can only be answered with "neither-nor".

Are they *discovered*? No. They did not exist before. Are they *invented*? No. The development of mind led to their appearance *with necessity*.

So even if one assumes that *any* being that has mind and is to a sufficient degree capable of thinking, must arrive at the numbers and at mathematics, this does not prove their independent existence. Rather it is the *interaction* of world 2 and world 1, which necessarily leads to mathematics, and not the platonic existence of mathematical concepts and propositions.

Numbers are elements of the worlds 2 and 3. In world 1, the material world, there are no numbers. Neither are there circles, circumferences or diameters. Also the lion, that appears on the carpet, is not a

materially existing lion, however the assertion that it appears *if* the carpet is woven is true, regardless whether it is actually woven or not.

None of the objects of world 3 is identical with an object of world 1. This applies also in those cases, where the temporal development of an actually existing system can approximately be represented by a mathematical system. Also the objects of such a mathematical system have no material existence. The mathematical system *is not* the real system, and the objects of the mathematical system *are not* the real objects.

From this *metaphysical* difference follows a *formal* difference. Objects, which exist in a mathematical system, are generated by the axioms and rules of the system in an algorithmic way. Actually existing objects, however, evolve from the fundamental law and the global conditions in a non-algorithmic way.

As stated before: during its unfolding through self-organization, reality sometimes approaches algorithmic describability – then mathematics and reality seem to touch each other –, but without ever completely reaching it. And at times real structures or paths of real objects resemble mathematical figures, like circles or ellipses, without ever entirely conform to them, and actually existing systems occasionally resemble physical systems that obey a law.

But ultimately, all natural laws – except the *fundamental* law, which however remains limited to the infinite Small – are about idealized systems, which are never completely realized. Therefore, natural laws, not other than circles or ellipses, are elements of devised worlds, which are only simulating the real world and which, for metaphysical reasons, can never fully conform with it.

6.4. The Source of the General

How does the General come into the world? In two ways:

1. Reality is generated from a single rule, which is fact and law at the same time.

The universe develops from this differential rule through self-organization. First, a global spacetime pattern is formed whose individual areas represent boundary conditions for the emergence of local spacetime patterns. These local patterns ("elementary particles") are sufficiently similar to each other so as to act as objects of natural laws. They in turn form patterns of higher order to which the same applies. This process is repeated a few times.

The objects, which develop in this way, present themselves to us as that what is the case, as the respective *Individual*. As individuals, however, they could not behave according to laws – for that the *General* is required which they are made from and which they carry in themselves.

So this is the first way in which the General enters reality: The rule which reality is made from is itself a General, and its general validity is inherited to the laws of the relationships between the spacetime patterns (objects) emerging from it – but only *approximately*, since there are only objects and circumstances that are *similar* to each other, and none that are *identical*; For the exact validity of such laws, however, identity of the objects and circumstances would be required.

In order to be able to formulate this fact at all, however, the General must already be present in the mind. It comes into the mind in the following way:

2. In the mind, all objects and all facts are represented by *attractors* of the dynamics of the system (the neural network) which generates the mind.

Attractors, however, cannot represent individual objects but only sets of (similar) objects: from the fact that each attractor has a basin of attraction follows that *similar objects* are represented by the *same attractor*. Thus, every perception, every concept is a *Universal*.

Since all (mental) objects and facts are Universals, the mental reality contains exclusively statements about Universals. Therefore, in the realm of what is perceived and thought, laws can be perfectly accurate, and true statements are possible. Applied to the material reality, however, they remain true only as long as the actually existing differences are disregarded – as e.g. when counting objects or performing calculations with objects. But in the description of the dynamics of real systems, it is neither possible to disregard the existing differences, nor can they be fully covered. So there are only approximations *on principle*.

To understand the relationship between natural laws and reality, both sources of the General are needed:

Without the knowledge of the fundamental law that creates reality, it cannot be understood why reality behaves according to laws and repeatedly approaches algorithmic describability; Hume's problem of the justification of laws is then unsolvable.

Without the knowledge that objects and facts are represented by attractors, the origin of the General remains hidden.

If the knowledge of one of the two sources was missing, then the adoption of a separate, Platonic existence of the General would be inevitable. However, like any kind of dualism or pluralism, this assumption would fail due to the unsolvability of the problem of the interaction: The question of how laws and objects are interrelated – that is: how the General *acts on* the individual being, or how it *is in* this being – could not be answered.

6.5. The Origin of Reality and of Mathematics

Everywhere and anytime the fundamental law is in effect and, by its action, generates the ever-changing fabric of spacetime. Simple objects emerge in the form of spacetime patterns. They join together to form objects of higher complexity. This process is repeated several times. Finally, objects evolve that are capable of replicating themselves. With this, the biological evolution starts. At last, it leads to objects that are equipped with mind. These objects – or let us better call them *beings* – capture the world through concepts which are universals. So they are led to the world of numbers. There, they discover the infinitely Small and grasp it through the concept of the mathematical limit. Equipped with this knowledge, they turn to the *origin of everything* and understand how reality unfolds by changing from instant to instant according to the fundamental law.

So this is the short version of the story of the emergence of mathematics and how it arrives at the *origin of everything*.

Reality itself does not apply mathematics. Just as the blade of grass does not calculate where to move but simply follows the wind that touches it, also the reality does not calculate its next step, but simply follows everywhere and anytime the differentially adjacent spacetime changes.

We, however, need mathematics to understand and describe how the fabric of reality unfolds, because, due to the lack of the *substance* and, with it, of the metaphysical quality *activity*, our descriptions are inappropriate to imitate directly what reality does.

Closing

I conclude with the famous aphorism of Zni Kiprot, the great sage of K-Pax:

*Tni bandan znu tirak – banorki,
Anzan tai kiprot
Bnurch taka znatorat.*

The (free) English translation is:

*The fox hangs its tail into the water,
but the wise man smiles to the horizon.*

P.S.:

Fnurxtix and *Srunkitax* – members of a species that has evolved from the Keas of the present and lives on Earth in 2 million years –, two gay archaeologists who, because of their passion for Germanic history, have adopted the artist names Hunobold and Haunohild, tell their friends that they like this book.

My dear Hunobold, my lovely Haunohild! Thank you so much for your positive assessment.



Summary

Each time I've come to the end of a chapter, I was chased by the idea I should have explained some things in an easier way. In some chapters I tried it, but I didn't succeed.

So I decided to place at the end of my work a summary which does not contain the full descriptions and explanations of the respective scenarios but only the basic concepts.

However there is also another reason why I think that such a list of the ideas that form the basis of the hypotheses presented in Parts 1 to 3 is important:

Compared with the established view of the universe, everything I have to say on any of the presented topics seems disconcerting or even absurd – even if *per se*, considered as single hypothesis, it appears reasonable and consistent. Only within the new global context, as part of a universe with different basic elements and connections between these elements, the various hypotheses prove their strength, by confirming each other and leading from different starting points independently from one another to the same results.

Therefore, the overall view is very important – and it is much easier to achieve it by a short summary than by a detailed text of several hundred pages, in which the completeness of the explanations is one of the main criteria.

Wouldn't it have been possible to present such an overview already in the introduction? No. As introduction, a new narrative about the universe would appear bizarre. As a postscript to a series of argumentations that have been designed as stringent as possible, however, it can serve to organize what has been read and to put it in a clear context.

Where to start then? With the *origin of everything*? That would be the perfect start if there were not already an interpretation of the universe. But since there is one, and because it has conquered its place as a fundamental explanation of the world – even though it explains actually nothing *fundamental* – I'm going to follow the order of the main text also in this summary: *First*, the path must be cleared, which leads to the *mechanism of the universe*. The omissions, errors, and, to say it openly: the crazy ideas, which now for more than a hundred years have been distorting the thoughts of all involved and have been causing the wildest speculations, must be corrected. Only then it is possible to begin with the intellectual adventure at the end of which one can understand what that, which exists, actually is.

So we start again with that fact, which seemed to prove the inconceivability of what happens at the bottom of things: the correlations between measurements on spatially separated quantum mechanical systems.

What is it about? In short about the following:

Be A and B two objects that interacted in the past and must therefore be described by a common function Ψ .

We want to determine the value $E(A)$ of an attribute E of A by a measurement. Ψ does not specify a definite value $E(A)$ but only a probability distribution, and the same applies to $E(B)$.

However, Ψ contains the prediction that $E(A)$ and $E(B)$ in any case meet a condition Z (this could e.g. be $E(A) + E(B) = 0$), such that after the measurement on *one* of the objects also the measuring value of the *other* one is known.

Now we perform a measurement on A. Then we know $E(A)$ and, because of Z, also $E(B)$. There are then two possibilities:

- (1) The measuring value $E(B)$ was determined already before the measurement on A.
- (2) *Before* the measurement, the measuring value $E(B)$ was not determined, *after* the measurement, it was determined. Thus, the measurement changed the state of B.

In the first case, the probability, which Ψ gives for $E(B)$, is a *normal* probability, that is: $E(B)$ has a definite value before measurement, we simply do not know it.

This would mean that quantum mechanics is *incomplete*.

In the second case, a *non-local* connection between A and B must be assumed, i.e. a connection which either is mediated by faster-than-light signals or exists without any mediation at all.

In this case, the probability, which Ψ gives for $E(B)$, is a so-called *objective* probability, that is: $E(B)$ does in fact *not* possess a definite value before measurement.

At first, it looks as if the choice was very simple: (1) appears reasonable and evident, (2) enforces the assumption of non-local connections and "objective" probabilities.¹⁶⁷

¹⁶⁷ Through the assumption of "objective" probabilities, the concept of probability is deprived of its logical basis. In the case of "normal" probabilities, the distribution depends on the (unknown) values of some variables. But *what* should it depend on in the case of an "objective" probability? *How* should nature comply with the predicted

So we decide – as did Einstein, Podolski and Rosen in their famous paper – for (1).

Now, however, an unexpected complication occurs through which our reasonable intentions seem to come to naught:

Under the assumption that (1) applies – i.e. that $E(B)$ is determined already before the measurement –, cases can be constructed that contradict quantum mechanical predictions. Thus it can be tested by experiment whether (1) *or* quantum mechanics applies.

The experiments clearly decide for quantum mechanics.

So (1) must be wrong, and (2) must be right.

Is that really true? Is the existence of non-locality and objective probabilities thus proved? Is reality actually that crazy?

Fortunately for us, the answer is *no*!

Indeed, the construction of the cases that contradict quantum mechanics – the so-called Bell's inequality – presupposes not only that $E(B)$ is determined already before the measurement on A , but it also contains *another precondition* which, because of its ostensible self-evidence, so far has escaped the attention of the physicists – the prerequisite, that is, that the measuring value depends *exclusively* on the object that was underway to the measuring apparatus prior to the measurement.

This additional precondition is needed, because the inequality contains also statements about *further measurements on the same objects*. Without such statements, there would only be the results of the measurements which *in fact* have been carried out, and no further conclusions could be drawn.

Now, if $E(B)$ simply represented an attribute of B , which B possessed already before the measurement, then of course it could be predicted which results *further* measurements on B *would* lead to.

But if $E(B)$ *additionally* depends on the time-varying state of the measuring apparatus, then such statements are not possible without involving this state.

distribution, if such variables do not exist at all? That would only be possible if nature could indeed "remember" the past events!

With this, the seemingly immovable logical scheme has changed: the previously determined case distinction in (1) and (2) is incomplete. Case (1) must be further divided, namely into:

(1.1) The measuring value $E(B)$ was determined already before the measurement of A *and* it depends only on B .

(1.2) The measuring value $E(B)$ was determined already before the measurement of A *and* it depends not only on B , but also on the time-varying state of the measuring apparatus.

(1.1) leads again to Bell's inequality and can therefore be disproved by experiment.

Thus the new alternative we are faced with reads:

Either (2) applies – the world is crazy, it is non-local and contains objective probabilities – *or* (1.2) applies.

What kind of cases should there be in which the measurement also depends on the time-varying state of the measuring apparatus?

First, it should be noted that these cases are by no means of an exotic or remote type, but indeed very simple measurement events. I remind you of the example from 1.3 in the First Part:

Here, balls with different weights are distributed into containers to the left and right. The value 1 is assigned to a measurement where the weight in at least one container reaches or exceeds 5 grams or multiples of 5 grams; otherwise the measurement value is 0

In this simple scenario, the measurement result is of course already determined before the measurement. Yet nothing can be said about the result of another measurement on exactly the same objects – the balls that have been distributed –, because this measurement depends not only on *these* balls, but also on the balls, which had been in the containers already *before*.

The example is particularly instructive, because – in spite of its simplicity – it contains everything which is needed for illustration:

The scenario is (of course) entirely *local*. The measurement results are determined already before the measurements. However, they are not only dependent on the measurement objects, but also on the time-varying state of the measuring apparatus – and, in the case of a whole series of measurements,

this means: on the *specific course* of the respective series –, and from this follows: *Nothing can be said about the results of further measurements on the same objects.*

Moreover, the scheme of the example can directly be transferred to the EPR scenario:

In the case of two entangled photons, for example, it must only be assumed that the measured transition is not caused by a "photon" but by the accumulation of wave intensities – completely analogous to the accumulation of the balls in the example.¹⁶⁸

However, it must be ensured that the condition Z, which is contained in Ψ , is met in each case during a measurement series. But that's easily achieved. (E.g. by expressing the probabilities of the measuring results through the covariance of the wave intensities, as demonstrated in 3.11 in the First Part.)

In this way it is possible, first to free the EPR scenario from the grasp of Bell's inequality, and then – after the path to local interpretations has been cleared – to reconstruct the quantum mechanical predictions for the measuring values in a completely local manner.

Thus it is by no means proven that reality is crazy; Rather there is reason to hope that reality is reasonable and just some of its interpreters are crazy, and this is – provided you are not one of these interpreters – certainly a very encouraging finding! Let us raise our glasses and drink to the reasonable reality!

Now, however, exactly that occurs, what I pointed to at the beginning of this summary:

For itself, the train of thought just conducted may appear consistent, but in the whole context of the interpretations of physical theories, it seems completely absurd. Since more than a hundred years, it is proven that transitions between different electron-states are caused by *photons* and not by waves. The wave-model is inappropriate for describing the interaction between radiation and matter. There is no "accumulation" of waves; photons are *indivisible* entities.

This certainty, and other ones, seem to prove that the local alternative I propose cannot be true and is simply absurd – *unless* the fundamentals of the whole network of physical interpretations are flawed.

Who would seriously take into consideration that this could be the case? And yet it is true, exactly this is the case: The entire physical interpretation network must be changed.

¹⁶⁸ The quantum mechanical formula for the event probabilities contains indeed *wave amplitudes*. However, they are simply not considered as amplitudes of existing waves but as square roots of probabilities.

Thus we state:

(A1) *A necessary condition for the local explanation of the measurement results in an EPR scenario is the assumption that the measurement events (the measured attribute values) are caused by the accumulation of wave intensities.*

*The discontinuous changes, which quantum theory owes its name to, must therefore be interpreted as transitions between (short term) stable local wave-states. Thus, only the observable transitions between the local wave-states are discontinuous and may appear like "jumps", but the causal process itself is continuous.*¹⁶⁹

Before we carry out, step by step, the transition from the concept "particle" to the concept "transition between stable local wave conditions" caused by wave accumulation, we first turn – as in the main text – to the interpretation of special relativity.

In the building of current physical theories, the special theory of relativity is the simplest component. It is confirmed many thousands of times and correct without a doubt. So what else should be said about it?

Only, that it is *un-interpreted*, and what I mean by that is that the fundamental insight from which the fact of special relativity arises *as a conclusion*, until now has remained undiscovered.

To elucidate what insight that is, I shall begin with a note of Einstein. In the book "Relativity: The Special and General Theory", he puts the reader the following definition of simultaneity of two events into the mouth:¹⁷⁰

"[...] the connecting line AB should be measured up and an observer placed at the mid-point M of the distance. This observer should be supplied with an arrangement (e.g. two mirrors at 90°) which allows him visually to observe both places A and B at the same time. If the observer perceives the two flashes of lightning [note by the author: which strike at A and B] at the same time, then they are simultaneous."

¹⁶⁹ An illustrative analogy are the transitions between the states of standing air-waves the in a wind instrument. Hearable (observable) is only a discrete sequence of tones that seem to change abruptly, whereas the actual causative process is continuous.

¹⁷⁰ A. Einstein, *Relativity: The Special and General Theory*, Really Simple Media, London, 2011, p 22f.

Einstein now argues against the reader that, in order to establish this definition, it would have to be *presupposed* that the light travels from A to M with equal velocity as from B to M.

(Of course the argument is aimed at the question of how this definition of simultaneity can be valid also for other observers moving relative to the first observer, for whom the velocities of light into different directions would apparently no longer be identical.)

Einstein then allows the reader to end the discussion victoriously by having him say:

"I maintain my previous definition nevertheless, because in reality it assumes absolutely nothing about light. [...] That light requires the same time to traverse the path $A \rightarrow M$ as for the path $B \rightarrow M$ is in reality neither a supposition nor a hypothesis about the physical nature of light, but a stipulation which I can make of my own free will in order to arrive at a definition of simultaneity."

Is that really true? Not at all! This "stipulation" has namely *consequences*, e.g. the slower passing of time in moving systems, and the question is whether nature is willing to comply.

In 2.4 of the First Part, I've presented a definition of time by sound signals, which is logically consistent and unambiguous, but still nonsensical, because nature does not care: observers who move with almost sound speed do *not* age more slowly according to the time defined by sound signals. And the reason for that is that the speed of the sound *is* in fact *not* equal for all uniformly moving observers, although I have *defined* it as equal through the definition of the time by sound signals. Nature, however, does not care about my definition, and therefore this definition applies only to sound and to nothing else.

This means: I can *not* stipulate the time at my discretion. I would *not* be able to *make* the speed of the light equal for all observers, if it *were* not equal – as opposed to what is the case with sound speed.

But then the question arises:

Why does nature obey the spacetime conditions defined by light signals?

To concretize this once again: according to the above definition, two events, which are simultaneous with respect to a resting observer X, are *not* simultaneous with respect to an observer Y who moves relative to X. Say, Y observes the event in A one second earlier than X, the event in B one second later.

For example: if for X both events occur at 12:00:00, then for Y the event in A occurred at 11:59:59 and the event in B will occur at 12:00:01.

But this means that, for Y, in A and B *is* another time as for x, and that *all possible processes that take place in the system of Y, must obey this changed time.*

All pairs of signals that are emitted from A and B at the same time as the light signals must, provided that they belong to the system of Y (that could e.g. be a spaceship), arrive at Y with a time difference of 2 seconds. And exactly that will be the case. But why?

Why, by the holy enlightenment – should the signals comply with this requirement?

Or: persons traveling with Y must age according to the time defined by light. And they will do so. But again the question is: why?

Why does reality comply only with the light-time and not with the sound-time or any other time?

Of course one can say it is simply that way – as indeed has been done up to now. With this, one identifies the relativistic formalism with reality. But reality is *obviously* not four-dimensional – it is a three dimensional space in which objects move.

And the fatal consequence of equating formalism and reality is that it prevents the fundamental insight that results from the answer to all these why-questions.

Which insight is meant? This ensues from the following train of thought:

Everything which happens, any change, is a *change of position*, which takes place at a definite velocity. If the time is determined by light signals, then *all these velocities* must comply with this time-definition.

If there were any processes that had no connection with the speed of light, then there would be no reason why these processes should conform to the time determined by light.

Thus any process must be related to the speed of the light. What kind of relationship could that be?

Evidently, the only way in which the adaptation of the velocity of the respective process to the time defined by light could be substantiated is that *ultimately* this process can be traced back to another, fundamental process which propagates at the speed of the light.

Therefore can be asserted (I quote from the main text):

There is in fact no difference between light and sound regarding the area of validity of the measurement systems based on them: both systems apply only to phenomena that can be derived from the respective kind of waves.

Therefore, the only possible reason why all existing processes comply with the time-determination through light, is:

Nature conforms to the measurement system of space and time determined by light because there is only light speed and phenomena derived from it.

From this follows in turn:

(A2) *Everything which exists and which occurs is an **interference phenomenon**, a pattern of superpositions of waves with light speed.*

In 2.6 of the First Part, I have shown that there is a direct connection between this assumption and the quantum mechanical description of material objects. Section 2.7 contains the proof that from this very assumption the relativistic spacetime conditions can be derived *directly* – without any further presuppositions and, as it should be the case with such a fundamental hypothesis, without any physics. The relativistic world is built anew from scratch.

As can be read from (A1) and (A2), both the restoration of the locality of the world and the explanation of special relativity lead to *waves* as basis of what exists and what happens.

Let us now turn again to the quantum mechanical phenomena.

The hypothesis (A1) now has to survive a first test. Is it possible to describe the phenomena that occur in the interaction between light and matter, which, at the beginning of the 20th century, defied all attempts at explanation by the wave model of the light – the Photoelectric Effect and the Compton Effect – on the basis of a pure wave model?

As it turns out, it is not only possible but incredibly easy. Again, the derivation succeeds without any physics. The only requirement is the Lorentz transformation, which has been deduced in the reconstruction of the relativistic spacetime conditions.

Since the desired results – in accordance with the assumption that a superposition of waves takes place – follow *exclusively* from the frequencies and lengths of the interaction partners light and electron, while any other physical concepts – also the particle concept – at this point prove completely

superfluous, here the concepts "frequency" and "wave-length" must be understood as *fundamental*, whereas the concepts "energy" and "momentum" have to be regarded as *derived*.

However, the defining equations $E = h\nu$ and $p = h/\lambda$ contain the quantity h , which presupposes the concept "mass" and is commonly considered to be just the one natural constant that connects the two aspects of existence – the corpuscular and the wave aspect.

Therefore, in order to justify the assertion that energy is derived from frequency and momentum from wave-length, the concept "mass" must be eliminated, or, to put it correctly: it is necessary to transform the concept "mass" from a basic concept into a derived concept.

This, however, can only be carried out later, in the context of the build-up of a metric-dynamic universe.

(A3) *The Photoelectric Effect and the Compton Effect can be derived on the basis of the assumption that the interaction between light and matter is a wave superposition. The derivation follows from this assumption alone; no physical concepts and relations are needed.*

The short version of (A1), (A2) and (A3) is: *There are only waves.*

Equipped with this assumption, we are now prepared to face the innermost sanctum of quantum theory, the *reduction of the wave function*.

The enigma we are confronted with reminds of the riddles known from tales and legends. Many who tried to solve it have lost their mind. In our civilization, their symptoms are revered as manifestations of the Holy Spirit of quantum mechanics and considered as alternative interpretations. I name only two of them: the assumption that the consciousness of the observer effects the reduction and the assumption that in each measurement the universe splits into some – or infinite many – copies of itself which differ from each other only with respect to the value of the just performed measurement.

To wrest the secret from quantum theory, we step up to the altar where many generations of physics students have sacrificed their thinking ability and spoken their *credo quia absurdum*, in order to be accepted in the circle of the initiates: to the *double-slit experiment*.

The following diagram shows what is supposed to be inexplicable:

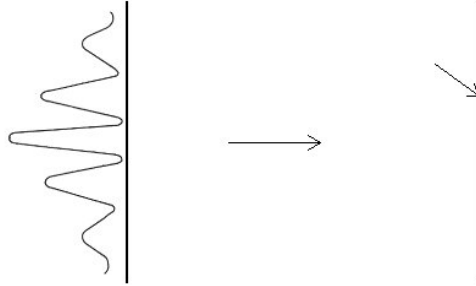

Left, the quantum-mechanical description of a particle at the moment of impact on a detector plate: *an extended wave* caused by diffraction at the double slit and subsequent interference.

On the right – at the position which the small arrow points to – the same particle at the next instant: *a microscopically small object*. The extended wave has disappeared.

Since the explanation in I, 3.6 is simple and understandable, I can be very brief.

The assumption (A1), through which the non-locality of the EPR scenario could be eliminated, already contains the answer to the question of what *actually* happens:

(A1) says that material objects – comparable to standing waves – can only exist in certain states which are defined by wave lengths. Waves that hit such objects cause *transitions* between these states due to the accumulation of their intensities. These transitions appear like jumps and are regarded as *particles*.

Thus the wave, which is depicted on the left in the above outline, does not disappear at all. Instead it permeates *everywhere* into the material wave-field – the detector plate – and, where the wave amplitude is not equal to zero, the wave intensities will cause transitions at later points in time, if further "particles" follow. And of course the rate of the transitions will depend on the magnitude of the quantity by which they are caused, that is: on the local intensity or the local amplitude square – exactly as prescribed by quantum mechanics.

The particle, which appears to the right in the outline at the position designated by the arrow, is therefore *not* identical with the wave on the left side of the outline. It contains also waves, which *previously* have arrived there.

And that's about all. With this, the quantum mechanical probability distribution of events in the double slit experiment is explained in the most simple way. Everything is local and objective, nothing disappears, there are no objective probabilities.

The secret has dissolved.

The choice of the double-slit experiment as example for elucidation, which physical process lies behind the quantum mechanical formalism, is basically arbitrary. The quantum-mechanical measurement scenarios are in fact all of the same kind: what is measured is always a wave or a wave packet, and only the type of waves, into which the packet is split, varies. It depends on the attribute whose value is to be determined.

Instead of a position measurement, one could, for example, analyze a momentum measurement. The momentum is assigned to the wavelength of sine waves. So the wave packet, whose "momentum" is to be measured, must be decomposed into sine waves with different wavelengths.

Formally, this decomposition is effected by the application of the momentum operator. One obtains then a distribution of amplitudes of sine waves with different wavelengths, which form the package. The amplitude square is interpreted as probability density of the possible events – i.e. measurements of momentum values that belong to these wavelengths.

Experimentally, the decomposition could be carried out through scattering on a crystal surface. The wave packet is *actually* split into sine waves with different wavelengths, which now propagate in different directions. Obviously, the distribution of the amplitudes of these waves must be the same as before the split when the waves still formed a wave packet, and, just as obvious, the probability of an event – that is: of a transition – in a detector which is brought into a beam path, must be proportional to the square of the amplitudes of the waves which enter into this detector.

In this way, the probability distribution of the events at a momentum measurement is explained completely and comprehensibly.

The same scheme can be applied to all quantum mechanical measurements. Each attribute corresponds to a particular type of waves.

In order to calculate the probability of a specific value of an attribute to be measured, it is required to decompose the wave packet into partial waves of the type that belongs to this attribute, and to determine the amplitude with which the wave that corresponds exactly to this value is contained in the

whole wave packet. The square of this amplitude must then be proportional to the probability of a measurement of this value.

In summary, it can be stated:

(A4) *In a world that consists exclusively of waves, all physical attributes must be traced back to wave-attributes. The quantum mechanical formalism is nothing other than a wave analysis, which serves for determining the amplitudes of those waves, whose intensities cause the transitions that are observed as measuring events through the accumulation of their intensities.*

The scheme is always the same as in the double slit experiment: No wave disappears, each makes a contribution to future measuring events. The "reduction of the wave function" is a normal physical process.

Also the so-called uncertainty is cleared up: it is a fact which, in the case of wave packets, is a matter of course.

So we have arrived at a local, objective world. The seemingly impenetrable fog that concealed what actually happens has lifted.

Having freed our mind from deceptions and prejudices, we can finally start thinking of what the world actually consists of.

This fundamental issue has even assumed a concrete form:

If there are only waves – what oscillates then? What is the law of this oscillation?

And furthermore:

Formally, an oscillation is the periodic change of the value of a variable. Which variable is it? In what context does it change? Is it really possible to trace back the whole physics to *one* such context?

The current physics does not contain any references to the sought answers. In this framework, there is not even an awareness of their absence. The retreat into mathematics, into the formal scheme is just too complete. That, which is being treated mathematically – the waves – is deprived of its existence, and it cannot be asked what that which exists *actually* is.

Therefore, in order to answer the "why" and "what is" questions, the project *cognition of nature* must be started again from scratch – not with the intention to change everything hitherto achieved, but to put it on a new basis.

So what is the primal ground of reality?

This time I will dedicate myself to this question a little more detailed. In its first presentation in the main text (in II, 1.3), I confined myself to the bare essentials, in order not to overload the train of thoughts metaphysically and instead let the concepts unfold over the course of the further conclusions.

However now, in retrospect, I'll try to say everything important already at the outset.

Let us first ask: How to arrive conceptually at this primal ground of reality?

On a very short path. One starts with some objects and asks what they consist of. If they are composed of simpler objects, one asks what *those* consist of. Thus finally one arrives at objects that cannot be further decomposed.

Is then the end of possible questioning reached? At first glance it may seem so. Although one can list the attributes of an indecomposable elementary object, still there seems to be no answer to the question of what e.g. an *electron* or a *string* consists of.

However, it is immediately evident that each object *must* consist of something: the assumption that it consisted of nothing would obviously be absurd.

So what does it consist of? Let us start with a definition. Let us call the attributes of an object its *accidents*, and that which it consists of its *substance*. The substance is then also that, what is left when all attributes are (mentally) removed from the object.

Just before, we noted that the substance cannot be *nothing*: an object cannot consist of nothing.

At the same time, however, it is obvious that the substance also does not meet the criterion of existence: something that has *no attributes*, does not exist. Having no attributes means not being able to interact with anything else, and to an entity that does not interact at all cannot be assigned existence.

Therefore, the substance can also not be *something*. Thus it is neither nothing nor something. It does neither exist nor not-exist.

This means:

Prior to any existence, there is not the alternative something or nothing, but there is that which is neither something nor nothing.

But that which neither exists nor not-exists is *necessary*, because for its kind of "being-present", there is no alternative: if it were removed mentally, then it would *not-exist*, it would be *nothing*.

Everything which exists, can also not-exist, every being stands in the alternative *be or not-be*. But that, what neither exists nor not-exists, has no alternative – it cannot not-exist, it is necessary.

With this, we have determined the ontological status of the substance: not as existence, not as non-existence, but as *necessity*.

At the same time, the *first and most fundamental question* is answered:

Why is there anything and not nothing?

The answer is:

There cannot be nothing, because prior to any existence, there is not nothing but that which is necessary.

For the further definition of what the substance is serves the difference between actually existing objects and objects that are elements of a description of reality.

Actually existing things are always *active*: the earth always exerts gravitation, the electron always carries electric charge.

However the things in a description are *passive*. I can attribute gravitation to the earth and charge to the electron, but without my intervention these accidents are not active; in the description, nothing happens *by itself*.

As opposed to an actually existing thing, a thing in a description does not consist of *substance and accidents*, but *only of accidents*. It is *defined* by its accidents, and it is *nothing but* this definition. Without this definition, the thing in the description disappears. There is nothing which it consists of, it does not exert any effects, which would have to emanate *from* something.

In short: the thing in the description has no substance.

Thus, substance is that, what provides the actually existing things with *activity*, that, what makes their accidents *active*.

So this is the metaphysical quality of the substance: *activity*

The question could arise whether the concept "substance" is in fact an *ontological precondition* of being or just a *logical precondition*.

A "logical" condition of an object represents something which is logically necessary for its existence. But an "ontological" condition of an object is something from which the object has *actually originated*. In the reality, the respective simpler, which a more complex object consists of, is always the ontological precondition of this object.

Therefore, in order to be able to apply this principle also to this Simplest and most General which our train of thought has led to – to the substance – it must only be recognized that *everything that exists has originated*.

This insight, however, is a matter of course. Assuming non-originated being means setting it as *absolute* and ascribing to it an ontological status that does not belong to it.¹⁷¹

Let us therefore assume that the substance of a being is not only the logical but also the ontological precondition of this being, such that the being has emerged from it.

By definition, the substance is that which has no attributes. This means: it is *indistinguishable*, and from this follows that it is not only the condition of *one* being but of *all* beings.

Therefore applies:

¹⁷¹ Moreover, due to this assumption *unsolvable* problems occur. Together with the absolute entities, natural constants appear, whose values are then unexplainable *by definition*. From this follows in turn the problem of the so-called "fine-tuning", i.e. the question of why the natural constants are tuned in such a way that a universe evolves which can bring forth life and, finally, mind. This question leads then to the so-called "anthropic principle" etc. It can be seen how a fundamental error continually produces nonsense.

However, the really fundamental problem of the assumption of non-originated being is that all "why" and "what is" questions are then *unanswerable*.

The substance is the *origin of everything*. I call it AGENT.

Why does the *origin of everything* unfold to being? Why does it not just remain what it "is"?

Because its metaphysical quality is *activity*. To remain identical, however, would be *inactivity*. Making a difference, however, means nothing other than ascending into existence.

Now the question is: *How* does being emerge from the *origin of everything*? ¹⁷²

As that what it is *in itself*, it cannot be thought. In order to be able to think it, we must ascribe to it a predicate.

Its metaphysical quality is *activity*. So this is the first accident: "activity". It must be kept in mind, however, that the concept *activity* as metaphysical quality is *more* than the concept of "activity" as accident. This "more" remains within the concept of the substance.

Due to this mentally performed division, the concept *substance* has changed. The substance that is connected with the accident activity is not identical with the *origin of everything in itself*.

In itself, it is undivided; it is *pure substance* and at the same time *pure activity*.

This first intellectual step – the division of what *in itself* is undivided – is precisely the act where *in itself* and *for us* separate. However, it concerns not only the *origin of everything* but also every being. Also on being, substance and accidents *in themselves* are *inseparably connected*, and only *for us* they appear divided. This unity of substance and accidents is the *essence* of being.

For example, consider the earth: it is inextricably linked with its accident gravitation; the *real* earth continually determines the orbit of the moon. For the *thought* earth, however, this is not true; in thought, the moon can be stopped at any time.

It is even easy to understand why this is the case: indeed the things of reality do not appear "as themselves" in our perceptions and thoughts, but in the form of representations, which result from the influence that the things exert on their environment, i.e. from their attributes or interactions.

¹⁷² This is to be understood *ontologically* and not *temporally*. It did not happen at some point in time, it is *always* the case. The *origin of everything* is what unfolds into being; it *is* this unfolding.

Therefore, of that, what existence is *in itself*, we experience only that part, which reaches us via our senses – either directly or mediated by technical devices –, and that part we call *accidents*.

Of that, what existence *additionally* is, we experience nothing. This part of existence is unthinkable. We only know that it is there, and call it *substance*.

On being, we are used to such an extent to presuppose the substance, that this fundamental deficit escapes our attention. At the *origin of everything*, however, the scheme of substance and accident collapses, and the *metaphysical difference* between that, what *is*, and that, as what we perceive and think it, is revealed.

It appears through the fact, that that, what every being consists of, disappears, if one tries to think it.

In itself, the *origin of everything* is undivided. It is *pure substance* and, at the same time, *pure activity*.

For us, the *origin of everything* divides into substance and accident. It is activity of AGENT.

AGENT is the *first substance*, activity is the *first accident*.

Activity means change. What changes? AGENT.

The indivisible unity of *substance* and *activity* expresses itself *for us* through the fact that AGENT exists only *as changing*. Without the accident change, there would be nothing.

If the change of AGENT remained without consequences, then there would again be just nothing – in contradiction to the necessity of the *origin of everything*. Thus, from the change must follow something, and this consequence must again be a change of AGENT.

Therefore, there must be two different changes.

Previously, we have realized that the *origin of everything* is *necessary* and that it must unfold into existence. Therefore, we can presuppose existence, and this means that, in order to determine these changes, we can use the necessary conditions of existence: space and motion.(alternatively: space and time).

With this, the first substance AGENT turns into SPACETIME.

Thus we have arrived at our first statement:

The change of space causes the change of motion.

But only if also the reverse is true, the perpetual chain of changes is created, which is necessary to prevent that there would again be nothing. Therefore, it must also apply:

The change of motion causes the change of space.

– And from this follows:

The change of space is equal to the change of motion.

I shorten the rest of the thought process that leads to the first equation:

There is no memory. This means, that changes can only take place from instant to instant. So they must have the form of differential quotients. Moreover, from that follows that there is no absolute size, which the changes can relate to. Therefore, they must be *relative* changes. These assumptions lead to the first equation

$$\frac{d\sigma}{dr} = \pm \frac{1}{c^2} \frac{dv}{dt} \quad (1)$$

– where σ is the metric density of the length (or the angle), and v is the velocity of the longitudinal (or transversal) metric flow. c is the (later) speed of light.

With this, we have reached the basis of the physical world. Now the metaphysical train of thought, which has led us to equation (1), must prove to be valid, which means: this equation must enable the derivation of known physical facts and theories and possibly also of new physical insights.

If these attempts are successful to a sufficient degree, then from equation (1) follows, that *everything which exists is a pattern of alterations of the metric density and the velocity of the metric flow.*

This is the right point to pause for a moment. Although already the new interpretation of relativity and of quantum theory may have seemed strange and disconcerting, and the tedious progress in rough metaphysical terrain may have caused consternation – the difference between my statements and those of standard physics is nowhere larger than here.

According to the convictions of most theoreticians, standard physics comes closest to the origin of being in the so-called M-Theory, which represents a unification of the different string theories. If this were true, then the fundament of the universe would be 11-dimensional. The according mathematics is so complex that hitherto no testable predictions could be deduced.

It seems unlikely that this is in fact the necessary condition for a universe. Much rather such assumptions have to be considered as symptoms of the decline of the paradigm, within which the physical progress has taken place up to now. This paradigm is no longer prolific.

Physics has begun with the observation of material objects, and it has never freed itself from the concepts that belong to these objects. They continue to exist as residual waste and, where physics approaches elementary facts, lead to absurd conclusions – I remind you of the reduction of the wave function. In this context, the assumptions of the string-theoreticians appear as last link in a chain of misguided interpretations, which, as long as the mathematics connected with them enabled verifiable predictions, remained in touch with reality, but which now, due to the abandonment of this criterion, are completely lost in an ivory tower.

The equation, which in this treatise represents the *origin of everything*, is not the final consequence of observations on existing things, but the first consequence of insights about this origin, which have been recognized as necessary. It is the *simplest possible* expression of them.

Precisely because of its simplicity it enables the maximum possible structural richness, and its purely differential form turns out to be the necessary condition for the existence of freedom.

This brings me to another important point that should be mentioned here: All concepts, which belong to the just performed metaphysical derivation, prove not only to be appropriate for the build-up of the physical world, but represent also the basis of the integration of mind into the reality built upon them.

Back to the physics that can be deduced from equation (1).

The first result is, that *in the metric flow* **waves with light speed** occur: longitudinal waves (later, they are associated with gravitation) and transversal waves (they belong to electromagnetism). Both kinds of waves appear in two forms: in the one, the periodically varying quantity is the metric density (of the length in the longitudinal waves and of the angle in the transversal waves), in the other one, it is the velocity of the metric flow (parallel to the direction of the flow in which the waves exist or normal to it).

With this, the fundamental conclusion is confirmed, which formed the central point of the interpretation of special relativity: *There are only waves with light speed. Everything which exists and which happens is an interference phenomenon, a pattern of superpositions of these waves.*

Now the knowledge is added, that the waves exist *in the metric flow*.

From this follows that in this universe there are only two basic quantities: metric density and metric flow. All other quantities are derived. The system of units consists only of two basic elements: a length-unit and a time-unit. It is a **metric-dynamic universe**.

The second result is the derivation of the **gravitation of a central mass** from equation (1). Both the Newtonian approximation and Einstein's version can be reconstructed.

For that the following metric assumption is needed:

Be R^3 an empty, flat continuum. Be r the distance of an arbitrary point P from a given point O . If in O a geometric mass m exists ($m = MG/c^2$), then the distance PO is reduced to $r - m$.

This means: Each point is m units closer to the center O than before. *The continuum lacks m units in every direction.* To the metric density σ applies then $\sigma(r) = (r - m)/r$.

Combined with equation (1), this results in Newton's gravitational acceleration $dv/dt = -MG/r^2$.

Before I continue with the representation of gravitation, I want to point out that, in the metric-dynamic view, electromagnetism is based on a metric deformation, which is completely analogous to the metric deformation in the case of gravitation:

In the case of gravitation, all distances from a central (geometric) mass m are m units smaller than in a Euclidean continuum. This results in an accelerated radial flow towards the center. In the case of electromagnetism, all circumferences of circles, in the center of which there is an electric charge μ (μ is the geometric charge), are by $2\pi\mu$ units smaller than in a Euclidean continuum. This results in a metric flow that rotates around the center.

This is a downright marvelous connection! Both interactions are explained in a way which reveals the underlying mechanism, and both prove to be direct consequences of the two interpretations of the fundamental law (1), with σ as metric density of the length or of the angle – thus being consequences

of a law, which *for us* represents the *origin of everything* and which has been derived in a purely metaphysical manner and without any regard of its possible physical usefulness!

Back to gravity. We interrupted the discussion of the Newtonian approximation.

From the point of view adopted here, the reason, why the application of the equation $dv/dt = -MG/r^2$ leads only to approximately correct results, is that it is not taken into account that the acceleration does not *act upon objects* but must be taken as an *accelerated metric flow*.

Exact results are obtained through the following model assumptions:

Gravitation of a central mass is a stationary metric flow, which is accelerated towards the center. *The continuum itself* flows towards the center. In the flow, waves with light speed exist. Objects are interference phenomena, patterns of superpositions of these waves.

Under these conditions, e.g. the light deviation or the perihelion precession can be calculated. Those who know the derivation of the perihelion precession by means of the general relativity theory, will be astonished that here it is done in a few lines.

Just as astonishing is that the representation is non-relativistic; It seems as if the true simplicity of the mechanism of the universe would reveal itself only to the absolute view from the outside!

Also the transition to the relativistic view is easy. Since the velocity of the metric flow and its differential length-measure are known, one can, at any point, transform to a local relativistic reference system. The totality of those systems is then the Schwarzschild metric.

In this definition of gravitation, at first the question remains open, *by what* the spherically symmetric metric defect is caused. I suppose that the superposition of waves, which the material objects consist of, leads to a metric densification, such that the exterior metric density will be lower.¹⁷³

The idea that a gravitating material object corresponds to a metric defect suggests the assumption that a gravitating object, which consists of **antimatter**, corresponds to the opposite metric defect. It would then be evident why matter and antimatter annihilate each other.

So if, in the case of matter, the continuum lacks m units in all directions, then, in the case of antimatter, there must be m units too much in all directions. Therefore, the metric density σ is not

¹⁷³ That would be a *non-linear* wave-effect.

smaller but greater than in the Euclidean continuum, and it applies $\sigma(r) = (r + m)/r$ or $\sigma(r) = (r - (-m))/r$.

Thus the geometric mass – and with it also the "normal" mass – of antimatter has the reverse sign: it is negative.

This means: If in O there is a mass $-m$, then any point is m units farther away from O than in the flat continuum.

The resulting metric flow is imaginary.¹⁷⁴ The Newtonian approximation remains identical; in the exact description, however, gravity is not greater than in the Newtonian approximation (as is the case with matter) but smaller: the perihelion rotates in the reverse direction – it is not a precession but a retardation.

Near antimatter, time does not slow down but accelerates. Nonetheless the acceleration is directed towards the center.

In the case of antimatter, the metric of spacetime is not the Schwarzschild metric. Instead of the correction factor $(1 - 2m/r)$, the factor $(1 + 2m/r)$ appears.

An important difference between matter and antimatter is that in the gravitation field of antimatter – i.e. in the accelerated metric flow – there are no longitudinal waves that are associated with gravitation, or, to say it more precisely: these waves disappear after a short time.

To derive further physical relationships, the following assumption is required:

The light-speed waves, which occur in the metric flows, form standing waves, whose wavelength is equal to the Planck length.

As was to be expected in a universe where there are only waves, the fundamental length is a wave length.

Therefrom now the following can be deduced:

¹⁷⁴ Since the energy of the field contains the square of the velocity v of the metric flow, also the energy is negative if v is imaginary.

Let there be in O a (geometric) mass m . It generates a spherically symmetric, stationary metric flow towards O. In the flow, there are standing waves with Planck length.

Because of the relativistic time-shift, for an observer resting relative to O the phase coincidence of the countermoving Planck-waves is canceled. Thus he does not observe standing waves but phase waves, to which the following applies:

The wave length of the phase wave is equal to the Compton wave-length λ_C of a particle with the mass m . Therefore, on a spherical surface around O with this radius an in-phase oscillation exists with the frequency of the particle.

The relation between the geometric mass m , the according wave-length λ_C and the Planck (wave-) length λ_{pl} , which follows from this metric-dynamic structure, is

$$m \lambda_C = \lambda_{pl}^2$$

Thus, the Planck-length is the geometric mean of geometric mass and according wave-length λ_C . This means there is a Z_m such that

$$m Z_m = \lambda_{pl} \text{ and } \lambda_{pl} Z_m = \lambda_C .$$

(E.g. in the case of an electron, $Z_m = 5.990 \cdot 10^{22}$)

The equation $m \lambda_C = \lambda_{pl}^2$ bridges over more than 40 orders of magnitude and provides a metric-dynamic substantiation of the relation between these fundamental quantities. Moreover, as will turn out subsequently, it is the gravitational analogue to the relation which is known from the atomic structure

$$r_e r_B = \tilde{\lambda}_{Ce}^2$$

where r_e is the classical electron radius, r_B the Bohr radius and $\tilde{\lambda}_{Ce}$ the Compton wave-length. Here, $\tilde{\lambda}_{Ce}$ is the geometric mean of r_e and r_B , and the factor, by which the quantities differ, is the fine-structure constant $1/\alpha$:

$$r_e \frac{1}{\alpha} = \lambda_{ce} \quad \text{and} \quad \lambda_{ce} \frac{1}{\alpha} = r_B \quad (\text{with } 1/\alpha = 137.036)$$

In the following, also this relation will be substantiated in a metric-dynamic way.

Let us look again at the equation

$$m \lambda_C = \lambda_{pl}^2$$

Since the Compton wave-length λ_C times the particle-frequency ν_m is equal to light speed, i.e. $\lambda_C \nu_m = c$, it follows

$$m c = \lambda_{pl}^2 \nu_m$$

This equation is the metric-dynamic equivalent to $M c^2 = h \nu$ or $E = h \nu$ and $E = M c^2$.

I summarize the basic metric-dynamic facts. (To be able to refer to it later, I call the following statement P1.)

(P1) In the metric flow caused by a central mass m , standing waves with Planck length exist. In a reference system that rests relative to O , phase waves occur. Accordingly, in this system, on a spherical surface around O with the radius of the Compton wave-length, an in-phase oscillation emerges with the frequency that belongs to m .

Of course this is not yet a model of the metric structure of a particle, but it is a reference to such a structure. And it is the first step of the metric-dynamic build-up of the atomic structure.

Before that, however, **electromagnetism** must be defined in a metric-dynamic way. Like gravitation, electromagnetism is a metric defect. Gravity is an alteration of the length measure, electromagnetism is an alteration of the angle measure. Compared with a Euclidean continuum, the metric density of the angle is altered.¹⁷⁵

In this way, electric charge is geometrized analogously to mass. The geometric charge has the dimension length. It is defined by the metric fact that the circumferences of circles, in the center of

¹⁷⁵ This metric "coexistence" of gravitation and electromagnetism can only be recognized in the flow-image of the two interactions, because only in this view, gravity relates exclusively to the alterations of the length measures in the flow-direction. Here, the universe consists therefore of *flow-lines*.

which there is a geometric charge μ , are by $2\pi\mu$ units different from those in the Euclidean continuum. Thus they are $2\pi(r - \mu)$.

In the case of positive charge is $\mu > 0$ (at the distance μ the circumference is 0), in the case of negative charge is $\mu < 0$ (at the distance μ the circumference is $4\pi\mu$).

The alterations of the lengths of the circumferences cause a metric flow. At gravity, the flow was radial, at electromagnetism, it is tangential, which means it rotates around the center. Both directions are possible. The velocity of the flow depends on the extent of the change in the arc differential in the same way as the gravitational flow depends on the extent of the change in the radial length differential.

In the case of positive charge, the flow is real, in the case of negative charge, it is imaginary.

Thus, positive and negative electric charges are related to each other in the same way as the gravitational "charges" of matter and antimatter.

Like the mass m , also the charge μ changes the time. With positive charge, time passes slower, with negative charge, it passes faster.

At first, this metric-dynamic scenario is again non-relativistic (like the gravitational one). However one can again change over to the relativistic view in the same way.

What immediately stands out is that the metric changes occur *in any plane* through the center. In each plane, the circumferences lack $2\pi\mu$, and therefore in any plane a rotating metric flow in both directions exists. These are precisely the facts that characterize the quantum-mechanical spin and make it appear as if it could not be interpreted in a realistic way.

But this applies only as long as it is seen as an attribute of an *object*. In the metric-dynamic view, however, the spin appears as an attribute of the *continuum*, and as such it is geometrically obvious because it is certainly possible to compose the continuum of planes and to assign to these planes attributes such as rotation.

That to a point must then be assigned the same velocity (of the rotating flow) *in any direction* on a plane (which lies tangentially to a sphere around the center), is not a contradiction. In the case of an *object*, it would be contradictory to assume that it moves in more than one direction, but not in the case of a point of the continuum – *actually* nothing moves. Here, the point is just a position and not an abstraction of anything existing.

From this metric-dynamic model of the electromagnetism can now be deduced the quantum mechanical **build-up of the electron shell**. As follows:

Let us assume, in a point O there is a geometric charge $\mu > 0$ (μ has the dimension *length*). It causes a rotating metric flow in any plane through O.

Now we imagine an *electron* positioned into this rotating continuum.

According to the arguments of the First Part, however, the electron is not a *particle* but an *oscillation state of the continuum*. And according to (P1), due to this oscillation state called "electron", an in-phase oscillation on a spherical surface around O with radius λ_c exists.

With respect to a plane that *rotates with the flow*, the phase-coincidence is canceled, and a phase wave emerges. (Note that this is only true with respect to the rotating plane. In the non-rotating system still a spherical surface oscillates in-phase.)

The attributes of the ground state of hydrogen can be derived from the condition, that the phase wavelength is equal to the circumference. From this follows first the Bohr radius, and then the frequency can be determined using the alteration of the time.

The values calculated in the metric-dynamic model correspond to the known values if the geometric charge μ is set equal to the classical electron radius r_e . Then the according rotation speed ensures that the above condition is met at the distance of the Bohr radius. With this, μ is identified as *geometric elementary charge*.

Therefore $r_e r_B = \lambda_{ce}^2$ turns into $\mu r_B = \lambda_{ce}^2$

Then applies $\mu / \alpha = \lambda_{ce}$ and $\lambda_{ce} / \alpha = r_B$.

Thus also these well-known relations are explained in a metric-dynamic way.

For a better overview of the whole scenario, which is composed of the condition of stationary phase waves in the radial flow $v(r)$ and in the rotating flow $w(r)$, here again the outline (S21) of II, 5.8.

(In spite of the logarithmic scaling, the proportions are not correctly reproduced. The actual values differ by 47 orders of magnitude: $m_e = 6.763 \cdot 10^{-58}$ meter, $r_B = 5.2918 \cdot 10^{-11}$ meter.)

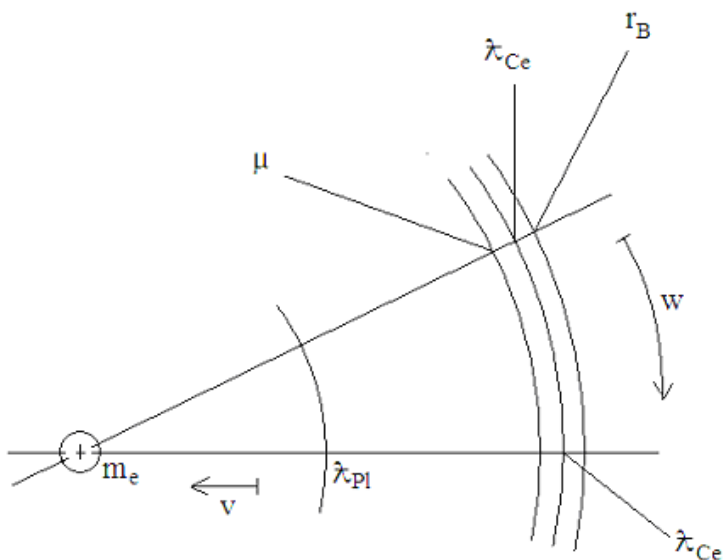

In the same way as the ground state, also the other states can be derived. It is indeed possible to derive all orbitals of the quantum mechanical description from the just presented simple metric assumptions – not only the orbitals of the hydrogen atom but also of all other atoms; including the orbitals with angular momentum $\neq 0$ – by regarding them as *oscillation states of the continuum*.¹⁷⁶

Precisely this assumption has been necessary for a local and objective interpretation of quantum mechanics. It has now been confirmed. Electrons are not "particles"; an additional electron simply means an additional nodal surface in the overall oscillation state.

So much for the reconstruction of the atomic structure.

Now sufficiently many known and unknown relationships have been derived in a simple and insightful way to provide the metric dynamic view the status of a plausible alternative to the usual interpretations. Its main advantage is that it combines gravitation and electromagnetism, matter and antimatter, positive and negative charge and some other hypotheses in a single geometric picture.

¹⁷⁶ That in the main text they appear as approximations is caused by the fact that I performed the calculations only with respect to plane sections through the spatial oscillation states. For this reason, the results correspond to those of the "old" quantum mechanics, which has been based on the assumption of particles that rotate in a plane.

Moreover, all results are in accordance with the new interpretations of relativity theory and quantum theory, which have been derived in the First Part.

(It is clear that a fundamental new approach cannot be subjected to the postulate of completeness. Still, I shall say something about the absence of the other two interactions:

The so-called shell-model of the nucleus can be reconstructed by applying the method, to derive from the rotation speed those radii where standing phase waves of the Compton wave-length of the electron exist, to the Compton wave-length of the proton.

Since the Compton wave-length of the proton is smaller than the geometric charge, this method leads inwards, into an area where the flow velocity is greater than the speed of light, or – in the relativistic description – where the metric becomes complex. This suggests that to a certain extent the weak interaction can be defined analogously to the electromagnetic interaction, with the difference that – compared with the geometric charge $Z\mu$ (Z nuclear charge number) – the one is directed *inwards* and the other one *outwards*.

Regarding the strong interaction, the following can be stated: if, as assumed in the metric dynamic model, the waves of quantum mechanics are *actually existing waves*, then somewhere – i.e. at a certain order of magnitude – a limit of linearity must be reached. Presumably this is the case in the order of the atomic nuclei. If so, then the strong interaction must be understood as non-linear phenomenon that relates to equation (1) with σ as angular density parameter.)

As mentioned, in the metric dynamic universe the only basic quantities are metric density and metric flow. All other quantities are derived.

Therefore, the basic quantity "mass" must be eliminated by *replacing* it with the quantity "geometric mass" wherever it occurs, which means: in all physical quantities which contain the unit kg, and in all equations which contain such quantities.

Then mass has the dimension length, and accordingly the dimensions of all quantities change, which contain the unity kg.

E.g. the dimension of force changes from kg m s^{-2} into $\text{m}^2 \text{s}^{-2}$, and the same transformation – division by [kg] and multiplication by [meter] must be performed with all mass-containing quantities.

With this, the transition to a purely geometric universe is completed, and now it can be claimed rightly – as announced already at the Photoelectric effect – that the quantities energy and momentum are derived from the quantities frequency and wave-length.

The gravitational constant G loses its status as independent natural constant:

$$F = G \frac{M_1 M_2}{r^2} \quad \text{turns into} \quad F^* = c^2 \frac{m_1 m_2}{r^2}$$

Analogously, Coulomb's law that describes the force between two charges Q_1 and Q_2 at the distance r (β is a dimensionless constant)

$$F_E = \frac{Q_1 Q_2}{4\pi\epsilon_0 r^2} \quad \text{turns into} \quad F_E^* = \beta c^2 \frac{Z_1 \mu Z_2 \mu}{r^2} \quad (\mu > 0, Z_1, Z_2 \in \mathbb{Z}, \beta \in \mathbb{R})$$

Finally, as in the main text, some remarks about cosmology.

It is well known how the idea that the universe is expanding has originated. On cosmic objects, a red shift has been observed, which increases with distance. It has been concluded that the objects are moving away from us, and therefore also from each other.

However there is also another explanation for this redshift: The objects do not move away from each other but the scales with which we measure decrease with time.

Since the length-measure is defined by a wave-length, and because we could indeed use any wave as measure, this means that all material wave-lengths decrease with time.

In other words: Not the universe expands, but we shrink – and, of course, at the same time all other material objects.

At first sight this hypothesis seems crazy – but only as long as the currently believed prerequisites are taken for granted. The redshift itself does not permit a decision between the two hypotheses – both are suitable for its explanation. Therefore the decision depends entirely on the view of the universe that one has *before* one decides for one of the two hypotheses.

In a universe that consists of elementary particles and fundamental constants related to them, one will decide, of course, for the expansion hypothesis. But actually, this statement is not correct, because there has never been a decision, the alternative has never been considered.

However, if there are no particles but only *metric changes* and nothing else, it's much more plausible to assume a reduction of the wavelengths.

Within the framework of standard physics, it is assumed that the ratios between the physical quantities remain constant *and* that these quantities themselves remain constant too.

In the alternative model, the assumption of constant ratios is sufficient.

Thus the standard interpretation requires *more* preconditions.

What about the various connections between physical quantities? Is it not absurd to suppose that they are preserved during such a contraction?

No. Due to the previous conclusions it has become clear why a reduction of wavelengths concerns *all* waves: all wavelengths are interrelated. The just performed geometrization of the atomic structure demonstrates that in an impressive way.

Yet also another reason speaks for the alternative assumption: size is a *relative* concept. It can be applied to everything that exists. But the universe as a whole does not "exist": the criterion for existence is interaction. With what should the universe interact?

The universe as a whole is *not relational*. So if there is an equation in which the size of the universe is related to the size of an existing object, then a change in this relation must always be attributed to the change of the object size.

In short: There are only relative sizes. The *additional* assumption of absolute size is logical luxury which falls victim to Occam's knife.

With the assumption that the universe is not expanding but the wavelengths are decreasing, the vexing problem – not to say the annoying nonsense – of the so-called *dark energy* disappears immediately: If there is no expansion, there is no "dark energy".

Also the logical and ontological absurdity of the assumption of a "Big Bang" is then finally removed.

Last but not least, also the assumption of *dark matter* can be dispensed with. According to Newton's or Einstein's view of gravitation, the observed gravitational effects of galaxies cannot be caused solely by the known (visible) matter. Hence one is forced to assume the existence of additional (dark) matter or to change the gravitational law. In my own view of gravitation, however, this ostensibly "additional" force results directly from the theory: here, gravitation is understood as *metric flow* that is caused by mass. This means: space itself "flows" toward the masses, it "pursues" them.

From this follows: If the majority of the gravitating masses rotates, then space rotates too. To an external observer, stars that are *at rest* in this rotating space would then appear as *moving*. Therefore, if one wants to calculate the rotation speed resulting from that part of gravitation that directs toward the center of the galaxy, the rotation of space must be *added*.

How does this alternative universe develop? Basically in the same way as the standard universe – with one notable exception: the alternative universe is *closed*, and *one* form of self-organization is therefore the formation of standing waves. The vast cosmic voids are likely such waves, and the clusters of galaxies are the "nodal surfaces".

With this, the brief introduction of the metric dynamic physical universe is complete.

Its basis is not observed facts, but metaphysical considerations, whose consequences, however, must conform to the observational facts. All physical statements follow from the fundamental equation and some additional metric assumptions.

There are only two basic quantities: metric flow and metric density, and hence only two fundamental units: meter and second.

Reality is a differential fabric of spatial and temporal changes.

When I created the metaphysical scenario that forms the basis of my physical hypotheses, I did not in the least expect that the notions and concepts, of which it consists, could carry that far.

Likewise, I was surprised when it turned out that in the reality which unfolds from it – as opposed to the current scientific reality – also the existence of mind and free will can be substantiated.

Observational facts, which are present in large numbers, permit only one conclusion: mind is brought forth by neuronal networks of sufficient complexity. To separate it from such networks and assign to it independent existence, lacks any justification.

The only reason for fantasies of this kind is the fact that the attempt to integrate mind into the scientific world view so far has failed due to two contradictions:

First, the assumption of free will contradicts the universal gapless validity of the laws of nature

Second, mental states are *qualia*: they are not only *information* but also *sensation*. It can be ruled out, however, that a physical state can become a sensation.

What can be observed in a neuronal network, is a neuronal excitation pattern. It can be described and understood as representation of internal or external circumstances.

But the sensation connected with it is not included in this description. What this pattern *is* – the quale, the unity of information and sensation – seems to transcend what can be observed in an inexplicable manner.

I start with the contradiction between natural causality and free will.

How does the causality of nature express itself in the description? Through natural laws and initial conditions. Laws are quantitative relationships between variables, i.e. equations, initial conditions are the values of the variables at a given time.

There are two types of systems: those in which the dynamic equations of the elements of the system are solvable and permit accurate prediction of the future, and those where these equations are unsolvable and the future is either not at all or only for a short time and approximately calculable on the basis of these equations.

An example of the first type would be a system of two bodies which are bound to one another by gravitation and isolated from the rest of the universe, an example of type two would be a system of thousands of such bodies.

Type two, however, must again be divided: there are systems with a large number of elements in which the equations of motion are not solvable, but where a prediction for the evolution of the system is still possible, because here, in addition to the natural laws, another law occurs, which owes its existence to the form or the structure of the system.

A simple example of such a law is the *oscillation law* of a jar. This law can be formulated independently from the physical structure of the jar. It is a law which is not derivable from the laws of nature, and which therefore must be added to the laws of nature in order to be able to describe the

dynamics of the jar.¹⁷⁷ This *law of structure* is the dominant law: it determines the global *and* the local dynamics, i.e. the movement of the individual elements.

Thus the form and structure of the object, its global attributes, determine the dynamics of the components and not vice versa. The concept of *causality bottom-up* must be complemented by the concept of *causality top-down*.

Another example is the *neuronal input-output law*. Through the form and structure of a neuron is determined how the electrical stimulation is generated, conducted, accumulated and eventually transmitted.

This law too is independent of its physical implementation. Precisely for this reason it is possible to replicate the neuronal dynamics by computer simulations.

Moreover, the neuronal input-output law also determines the dynamics of the neuronal network. The network thus forms a separate layer of reality which must be described as such. From this perspective, the neuronal network is a cybernetic system whose elements are neurons, the interaction of which obeys the neuronal input-output law. This law is a *law of structure*, and it can be regarded as interaction law of neurons.

As with the gravity scenario with thousands of bodies, we are confronted here with such a large number of elements (neurons) that interact with each other either directly or over a small number of intermediate steps, that it is impossible to predict the temporal development of the network, *unless* the circumstances are not as in the gravitational scenario but as with the jar, where, due to the occurrence of another law, the motion of an enormous number of particles is organized in a simple manner.

Is there such an additional law in the neuronal network? The answer is *yes*. As follows:

The neuronal input-output law determines the dynamics of a network only as long as this network is not connected to the outside world. However once such a link exists, the neuronal excitation patterns depend on external circumstances. They are then caused by information that reaches the net via the sensory organs, and *represent* something.

If a pattern exists for a certain time, then the neuronal connections that are active are amplified. Thus the pattern becomes an *attractor* in the state space of the neuronal network.

¹⁷⁷ If it were supposed, however, that from a state of the universe follow all subsequent states, it could still be argued that the oscillation law is derived. This assumption will be refuted subsequently.

The sequence of such patterns is at first determined by the sequence of events, the elements of which the patterns represent.

However, since the patterns are indeed attractors of the neuronal dynamics *itself*, there is the tendency that the network will produce them also *independently of external circumstances*, and that also their sequence is controlled internally by enhanced neuronal connections, i.e. by *associative* links.¹⁷⁸

The state space of the jar, which has previously served as example, is structured by a few attractors, that is: by the possible oscillation states of the jar. Causality works top-down: the global conditions are the cause of the movements of the particles.

In the neuronal network, the situation is analogous: here, in the state space a large number of attractors exist. The entire dynamics of the network runs from attractor to attractor.

Again, causality acts top-down: global conditions – the structure of the state space, i.e. the attractors themselves and the transitions between them – determine the temporal evolution of the network and thus the local neuronal processes.

We now identify *mental processes* with the just described dynamics; thus we have determined *mind* as an autonomous layer of reality. It is dominant in the neuronal network, which means: it causes what happens.

It is therefore wrong, to regard mind as a *neuronal phenomenon*. Mind is a layer of reality, which lies *above* the neuronal layer, just as the neuronal layer lies above the molecular layer. Just as molecules are elements of neurons, neurons are elements of mental states. And just as the neuronal dynamics that results from the neuronal input-output law represents an autonomous layer of reality which cannot be derived from the molecular dynamics, also the mental dynamics represents an autonomous layer of reality which cannot be derived from the neuronal dynamics.

For the proof of free will, however, a further step is necessary.

There is no doubt that mental processes are subjected to rules. So have we only exchanged physical causality for another one?

¹⁷⁸ However this will only be the case, if the network contains *functionally unbound areas* in which such internal feedback-processes can develop. Otherwise, the sequence of attractors (representations) would remain entirely dependent on the architecture of the network and external circumstances.

No. The difference between the laws, which physical systems are subjected to, and the laws which mental processes obey, is that in physical systems, though new states can occur, the laws still remain the same, whereas mental processes can change their own laws, while they run.

The physiological basis of this fact is Hebb's law, which says that adjoining neurons that are simultaneously active reinforce their mutual stimulation. Conversely, unused connections are degraded.

Thus the neuronal encoding of mental contents is modified.

But the change in the structure of the phase space of the network, which takes place due to this feedback, must again be attributed to the dominant layer of reality, which means: it is a mental phenomenon and not a neuronal one. Hebb's law represents only the necessary condition for the fact that mind can change and determine its own laws.

Thus there is no system of laws and initial conditions, in which mental processes and decisions of the will are completely contained. To the question of why a person has decided so and not otherwise, there is then only one permissible answer: *Because he/she wanted it that way.*

We have come to the conclusion: *Free will exists.*

Still, our train of thought is incomplete. We have assumed global entities and causality top-down to be autonomous phenomena. It is therefore necessary to show that the global conditions cannot be derived from previous states. (If they were derivable, then they would not be an independent element of reality and its description.)

So we ask:

Is there a procedure by which the future can be calculated from the present with a finite number of steps?

In this case, the future would be *completely* contained in the present – with all phenomena, including mental processes and acts of will; the claim of causality top-down would then be impossible, and freedom would be an illusion.

It is important that the question is only about the *existence* of such an algorithm and not whether *we* know it or whether we are able to execute it if we knew it. (Both can definitely be ruled out.) By its very existence, the assumption of freedom would be disproved.

So we must ask whether in that reality, which has been presented here in its basic features, such an algorithm exists.

As starting point serves again the difference between reality and description: Reality has the metaphysical quality *activity*; By contrast, descriptions of reality – as well as models and simulations – lack this quality: *by themselves*, they are passive.

That reality is *active* means that it executes at any position and at any time the fundamental, purely differential law – and this execution is a necessary *and* sufficient condition that the future evolves from the present. Because of its *activity*, reality need not step out from the infinitely Small and "know" the uncountably many relationships between the points of the continuum, which lie separated from one another. It is sufficient that it follows everywhere and anytime the adjoining differential spatial and temporal changes.

However, the way in which reality generates the future from the present cannot be imitated in descriptions. Descriptions are *passive* – nothing happens *by itself*, the law is not executed. Therefore, for us it is imperative to know the relationships between spatially or temporally separated points of the continuum *already now*, if we want to derive the future from the present. This means that we need a method that enables us to step out of the infinitely Small and make statements on finite areas. In other words: we have to *integrate*.

One glance at equation (1) is sufficient to see that this is not possible. In order to integrate, more information is needed. Moreover, in the general case cannot be presupposed that metric density and flow velocity are calculable functions.

It is therefore necessary that the area, about which something should be stated, contains *more order* than is already given by the law alone.

This means:

In the general case, there is no algorithm to calculate the future from the present. The future is not contained in the present. It does not follow from the present.

Thus the only way to know the future is to wait until it happens.

Is reality determined or not?

From a formal point of view, this is an unanswerable question. From an ontological point of view, however, reality is neither determined nor not-determined. This alternative is valid only for descriptions of reality. To reality itself, it is not applicable.

Simplifying, one could say reality was something "in between", but that would only obscure that also in this respect the essence of reality as a unity of *substance and accidents* is not conceptually accessible.

The facts presented above can also be expressed as follows:

In a description, the relations between spatially or temporally separated points of the continuum must be given *explicitly* or made explicit by an algorithm. In the reality, they remain *implicit*; only through the development of the future and the order that at the same time emerges, they become explicit.

What is this "emerging order"? It is being and its laws. Through self-organization, the *origin of everything* unfolds to being, to *objects*, and these objects then form the first layer of existence. To this layer also those laws belong that in current physics are considered as fundamental interaction laws.

An example for that is gravity of a central mass, which, in the metric dynamic view, follows from equation (1) and an additional assumption about the metric density.

But also in this layer of existence, the future is calculable only in simplified, idealized cases, as e.g. in the case of two bodies, which are isolated from the rest of the universe. In the case of 1000 bodies, the illusion of calculability disappears completely.

If this evolutionary game repeats itself, i.e. if from the simple objects and their interactions develop more complex objects and according new laws of structure, then again the same applies: only under simplified, in fact never entirely realized conditions the new laws also provide an algorithm for calculating the future.

Due to the formation of order through self-organization, reality repeatedly comes close to algorithmic describability in the course of its evolutionary development of objects and structures of increasing complexity, but without ever reaching it completely.

With this, the idea dissolves that reality is determined by causality bottom-up, i.e. by an elementary layer. In the general case, this kind of description permits either only an approximately correct prediction of the future or none at all – and I emphasize again: this restriction of predictability does not

exist because we do not know the appropriate algorithm for calculating the future, but because *there is none*.

In this way, space is created for causality top-down, i.e. for the assumption that *global conditions* are causes of local changes.

Causality top-down is described by laws that contain *global* parameters, causality bottom-up by laws with *local* parameters. Neither of the two descriptions is derivable from the other. Both types are necessary for the understanding of systems. But they do *not* unite to a deterministic representation.

This completes the first part of the task, to bring mind and matter under one concept. Mind is an autonomous area of reality, and it is free.

To arrive at this result, it was sufficient to regard mental activities as information processing. It was not necessary to factor in that all mental states are *qualia*, which means that they form an indivisible unity of *information* and *sensation*.

But now, this very fact becomes the focus, for the second part of the task of bringing mind and matter under one concept is to clarify the question:

How is it possible that a neuronal pattern turns into sensation? Why does a physical being transform into a quale?

Again, the explanation begins with the ineradicable *metaphysical difference* between being and that as which we perceive, think and describe it:

Actually existing objects consist of *substance and accidents*. In contrast, objects in a description consist *exclusively of accidents*.

With this, the substance is determined as that which is lacking in our descriptions of reality. This "lacking" – that, what the existing thing is *more* than the thing in the description – cannot be thought. It is necessary, however, always to include this difference in our understanding of reality.

So if we ask: *How can a physical being become a quale and contain sensation?* – then it must be remembered that this physical being – the neuronal excitation pattern – as *Existing* is in any case *more* than our concept of it; Our concept contains only the accidents and not the substance of this being.

Because of this fact now can at first be determined what the substance and the accident of the quale are: its accident is what we can capture and describe, that is: *meaning*, its substance is what eludes our thinking and our descriptions, that is: SENSATION.

SENSATION is thus the substance of the mental being. I call it *second substance*. However it is not independent of the first substance SPACETIME or juxtaposed to it, but emerges from it.

Now the question is: Why is the first substance SPACETIME transformed into the second substance SENSATION?

It must be kept in mind, that here the concept SPACETIME is a *metaphysical* concept which is not identical with the physical concept. The physical concept "spacetime" consists of nothing but its definition – it is as substance-less as the term "neuronal pattern" – whereas the metaphysical concept SPACETIME is a *substance concept*.

SPACETIME has the metaphysical quality *activity*, which manifests itself *for us* through the fact that the physical spacetime exists only *as changing*; without its accident "change", it is nothing. SPACETIME is what provides the physical entities – patterns of changes of spacetime – with *activity*.

With this, the conceptual gap between the first and the second substance is reduced: the first substance SPACETIME is what provides the material entities with *activity*, the second substance SENSATION – i.e. feeling, instinct, motivation, etc. – is what provides the mental entities with *activity*.

However this consideration is not more than a first approach to the problem of the transformation of the substance and not an answer to the question, why it occurs. To this answer leads the following train of thought:

The nature of what exists seems coherent throughout: everything that exists can be regarded as element of a cosmic evolution, in which the more complex things emerge from the simpler ones. Only if one penetrates to the foundations of existence, the irreconcilable difference between what is and its description reveals itself.

However, that which cannot be thought on being, does not prevent us from understanding the observed phenomena – but only up to the point of the evolution of nature where neuronal networks of high complexity develop, because then also a phenomenon emerges, which escapes not only the scientific but indeed *any* kind of description: *sensation*.

What is the reason for this gap?

Since the substance cannot be thought – neither as first nor as second substance – the argumentation must take place in the area of the accidents.

During the evolutionary development of nature, new, more complex layers of existence with new accidents emerge. Thus the accidents change.

The change of the substance must be connected with the change of the accidents. This means: the reason for the change of the substance must be found in the fact that – in the evolutionary transition from entities without mind to entities with mind – a change of accidents takes place, which is of *another kind* than the changes of accidents which previously occurred in the course of the evolution.

So what is it, what do the changes of accidents have in common, as long as they occur in the area of matter, and what distinguishes the change of accidents associated with the emergence of mind from all these other changes?

It turns out that the following applies:

Accidents, which occur during the formation of new, more complex layers of being, can – as long as these new beings do not possess mind – be reduced to accidents of simpler layers of being.

Here is an example: The accident *gravity* follows from the law of the continuum and an additional metric condition. It is therefore not necessary to regard mass as new substance, i.e. as new unthinkable metaphysical entity – as is the case in standard physics.

This deducibility of accidents can be found in all evolutionary layers of being up to simple neuronal networks that cannot bring forth mind.

In such simple networks, the information processing is stereotyped, in the form of a reflex or a learned program. Thus the neuronal processes can be understood as functions of the given architecture of the network and external conditions.

The behavior of animals that possess neuronal networks of this kind can then also be understood in this way.

Let us now consider neuronal networks that produce mind. Here, the neuronal processes are not stereotypical, stimulus and behavior are not always in a fixed connection. The sensory information is subjected to *further processing*.

In the previous train of thought by which free will has been substantiated, we found that a necessary condition for the emergence of mind is the existence of functionally unbound neuronal areas where internal feedback processes can take place. Here, the attractors of the dynamics of the network – neuronal patterns that represent something – form a network of higher order, i.e. they relate to each other and thus also change each other. The information content of these patterns is therefore increasingly determined by the *internal relationships* between the neuronal states, while the original functional dependency from the architecture of the network and external conditions fades away.

In this way, representations turn into *intrinsic meanings*.

So this is the desired difference between the changes of the accidents in the area of matter and the change of accidents in the transition from matter to mind:

Intrinsic meaning, the accident of mental states, cannot be deduced from accidents of simpler layers of being.

With this, it can now be explained why, *for us*, the emergence of mind means at the same time a transformation of the substance. As follows:

Everything that exists consists of substance and accidents. They are *inextricably* linked with each other.

The first substance SPACETIME is linked with the first accident *change*. Let us now consider an arbitrary accident that occurs on a higher layer of being. What is the associated substance, and wherein consists the connection between the two?

The answer is: As long as the accident can be derived from simpler accidents, it is – through these accidents and further, again simpler accidents – *ultimately* connected with the first accident and thus also with the first substance.

But if an accident appears that cannot be derived from simpler accidents – as is the case with mental accidents – then the connection with the first substance is severed. Therefore, the first substance can no longer be the substance that belongs to this accident, and this means that now *for us*, together with this accident, a new substance has emerged, or, in other words, the substance is transformed.

With this, we have reached our goal. The transformation of a material object into a quale is explained. Mind and matter are brought under one concept.

However, there is a third kind of entities: entities that are *produced* by beings with mind. An important example, which has been discussed here many times, is *descriptions of reality*.

Also entities of this kind fit into our conceptual framework. They are defined through the fact that they consist *only of accidents*. The physical prerequisite that they need – the paper on which the description is noted, or the computer in which the simulation runs – is not the substance that belongs to the accidents of such entities but only the *material basis* of these accidents.

This is also the metaphysical reason why the *simulation of mind* is impossible: Since the accidents of the simulation lack the substance, no transformation of substance can occur. The states of the simulation do not turn into qualia, information does not turn into sensation.

Thus, the summary of the trains of thought that lead to a complete concept of reality, a concept that encompasses all that exists, is completed.

As in the introduction, I shall close with some unsystematic remarks.

The difference. How could the difference between the understanding of reality that follows from my basic assumptions and the current view of reality be described, if it should be summarized in the shortest possible way? Presumably in the following manner:

According to the current scientific believe, reality is composed of *elementary objects* whose existence is associated with the occurrence of *absolute quantities* (natural constants). The basis of this view is a concept of existence that stems from the objects of our everyday experience.

By contrast, the reality that I present is not built upon *existence* but upon *change*. *Existence* is a derivative concept. Everything that exists has originated. Objects are patterns of changes of spacetime. If an object is elementary, then it is indivisible not as substantial entity but as *shape*, as e.g. a standing wave. There are no absolute quantities, but only *relations* between quantities.

In standard physics, there are several fields or interactions. The path to simplicity leads over the unification of these interactions.

The metric-dynamic model *begins* with the Simplest. There is only one fact that weaves reality. It is fact and law, Individual and General at the same time. It is *necessary*, and with it also that what it weaves: reality.

In the conventional view of reality, the natural causality is all-encompassing. Despite quantum mechanics and chaos dynamics, there is no room for mind and free will.

In my view, reality is a *differential spacetime fabric*. The differential law, however, is not an algorithm; causality bottom-up is incomplete and must be complemented by causality top-down. There is room for mind and freedom. The attempt to capture reality through an algorithm leads to a depletion of reality: The metaphysical quality *activity* and the substance SENSATION disappear. *Mind* is then impossible.

The most important difference, however, is the following one: In the current description of nature is not differentiated between an existing object and its description. The formalism has absorbed the reality. Reality itself has disappeared. *For us*, it therefore withers to a mathematical system whose development is completely determined by laws, which exist from the very beginning and whose origin remains unexplainable.

From my perspective, the conventional understanding of nature therefore suffers from a fundamental metaphysical defect, because only the conceptual determination of the *metaphysical difference* between reality and description makes reality accessible to us and enables us to achieve a *complete concept of reality*. This reality *is not* a mathematical system. Except for the one fundamental fact or law that follows from the necessity of the *origin of everything*, all laws have *emerged*. The future is open.

The fabric of reality is made of infinitely small meshes. This means: The world is not "what is the case", not a set of "facts". Although the world presents itself to us in this way, we know at the same time: everything that is the case is made by the differential law that generates reality.

"Facts" are a too coarse network, by which reality cannot be fully captured. Mind, sensation and freedom fall through its meshes. With this, also statements like: "Everything has a sufficient reason" become obsolete. Whatever could be formulated as "reason" for an "event", as "cause" of an "effect", can only represent an approximation of what actually happens, because "reason" as well as "event" are *ultimately* made of uncountable sets of differential circumstances which cannot be combined to finite verbal or mathematical statements.

Therefore, already the division of what happens into causes and effects is inadmissible. There is neither the "present", defined as set of present facts, nor the "future", defined as set of future facts, but only the differential process which contains both, present and future, as well as the transition between them.

The metaphysical concept "activity". Thought objects are passive, existing objects are active. For this reason, to that which actually existing objects consist of – to the *substance* – must be attributed the metaphysical quality *activity*.

Here, however, not a certain mysterious metaphysical entity called "activity" comes into play – this attribution just means that the concept "being" changes from a *static* into a *dynamic* one. Being is then no longer something that *can* be active but something that *must* be active; without *activity*, it is no being. There is no longer existence *and* activity but only both together. Being doesn't need to be *activated*; it *is* active. The static concept of existence is a consequence of the *a priori* separateness of substance and accidents. The insight that *in themselves* they form an indivisible unity leads necessarily to a dynamic concept of existence, in which existence itself – seen as pattern of changes of the flow of AGENT – turns into a process.

Formally, the transition from a static to a dynamic concept of existence corresponds to the transition from time *points* to time *differentials*; there is then no present instant and no future instant but only the differential progress in time. Time differentials are the basis of a dynamic reality, and they give processes a direction: what happens within a time differential carries in itself the germ of the following development. In contrast, a reality that is seen as succession of time points would be static and directionless.

The metaphysical concept "necessity". A friend told me, the derivation of the necessity of being from being itself reminded him of the story of Munchausen, who saved himself from the swamp by pulling on his own hair.

Although I like the comparison, I do not think it is justified. Munchausen obviously missed *something* he could hold on to for pulling himself out of the quagmire. But we have this *something* we can base our conclusion upon: *that* something exists is simply a fact. What exists must have *originated*. Thus one is led to the *origin of everything*. It does neither exist nor not-exist. Now if there were *nothing at all*, then also the *origin of everything* would *not exist*, and this possibility has just been excluded.

I suspect, the difficulty to comprehend this conclusion follows from the fact that here a well-known inference schema is overruled. As follows:

Let p be a predicate such that for every existing object holds that either p or *not* p is true. Let X be an object for which neither p nor *not* p is valid. Then the usual conclusion is that X does *not exist*. But if the predicate p is "*exist*", then this conclusion is inadmissible, because it leads to a contradiction: if X does neither *exist* nor *not exist*, then obviously it cannot be concluded that X does *not exist*. Thus, the

only remaining possibility is to assign to X an ontological status that is neither *existence* nor *non-existence* but indeed *necessity*.

So it is the particular, fundamental rank of the predicate *exist*, which forces us to step out of the usual inference schema and to introduce the metaphysical concept *necessity*. But only if the concept "exist" is used in its *ontological* and not only in its *logical* sense, this procedure is admissible.

The concept-pair "in itself" and "for us". When it comes to the difference between thinking and reality, this pair of concepts is almost inevitable. However, there is the danger that too great a distance between thought and reality is suggested.

So I want to emphasize again, that reality is fully disclosed to us – however with the one fundamental exception that that, from which every being originates and which is *in* every being providing it with *activity*, cannot be thought as that what it "is".

On the other hand, precisely the inseparability of substance and accident guarantees that being reveals itself to us through its accidents. There is no reason to assume that there is anything on being which must remain hidden to us.

The concept *for us* also gives the impression that our thinking is not objective. However, there is no doubt that the physical things are *for each other* exactly what they are *for us*, if one uses for the comparison only the information content of our concepts, and from that in turn only the physical part.

A billiard ball is for another billiard ball, which it hits, exactly that physical object as which we consider it. Even if we are not equipped with the correct theory of the interaction, still the perceived event corresponds to the actual event.

This can be claimed because the things interact with each other only through their accidents or interactions, i.e. in the same way as they interact with us. Therefore, via the sensory information precisely what happens is transferred to us. Thus our image of reality is *objective* – but only if we manage to liberate our concepts of what our mind has added to their objective meaning, and what it has changed on them. As history up to the present demonstrates, this is a difficult task. However, it is important to recognize that no *fundamental metaphysical* obstacle stands in the way to an objective view of reality.

Only at the very basis of things, our thinking fails, but that is beyond the border of the area where objectivity can be defined at all. And also here, as noted above, there is nothing hidden or mysterious,

nothing that could give rise to further speculations or justify religious, esoteric and scientific projections and fantasies.

Epistemological doubt. With what has just been said, some kinds of epistemological doubt are associated, which however are so absurd that I would not mention them if they were not so common.

There are doubts about the objectivity of our perceptions of space and time that sometimes go so far that even the geometric structure of our immediate environment is called into question. This is utter nonsense! If the space around us were not exactly as we perceive it, then could not be explained how, in a child's development, tactile and visual space representations evolve together and finally coincide, then it would be a mystery why cameras with optical devices, which are similarly designed as our eyes, produce images that we recognize as what we have seen, and... here, a long list could follow. Anyone who thinks he is deceived about the spatial and temporal circumstances should be taken seriously and receive traffic ban!

Even the more general doubt whether there is space and time at all is absurd. Without space, there is no being. Without time, there is no change, which means again no being. And these two assertions apply *in any case* – no matter what kind of being we have in mind.

Space and time arise directly from the first, fundamental statement: *One change is equal to another change*. One change *becomes* space, the other *becomes* time, and being is always a *pattern of such changes*.

This is true with respect to *any possible* reality. It is not necessary to start with space and time of the physical world; instead *any* parameters could be introduced. However, no matter how the two changes are initially understood, finally they will be in any case equivalent to space and time of the universe as we know it. It is – in this sense – the *only possible* reality.

Space and time are thus undoubtedly objective, and, in our environment, they are exactly as we perceive them. Only when it comes to the question of the structure of space on very large or very small scales or in the vicinity of large masses, or to the question of the passing of time dependent on high relative velocities, we need to modify and extend our view of space and time.

But again, here the same applies as before: only at the *origin of everything* may be asked, whence space and time come. If something exists, however, then there are space and time. They are *objective*.

Constructivism. The constructivist doubt about the perceived reality is based on the assumption that we do not map the world but construct. Our mental picture is therefore not a picture of reality, but only the result of a game that the neurons play with each other.

About this assumption, the following is to be said:

Of course we are not just mapping the world. It is obvious that a mere map would not suffice to orient oneself in an environment with constantly changing situations. For that it is necessary first to disassemble the environment into objects and relations, and then to rebuild it. To accomplish this, a complex neuronal apparatus is required. This apparatus operates economically and can be deceived. Such mainly optical illusions are entertaining, but they do not substantiate epistemological doubts. (Whoever holds the opposite opinion should, as I said, be taken seriously and excluded from participation in the traffic.)

An outline for illustration¹⁷⁹:

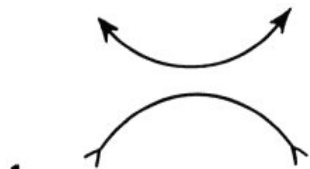

1

Note that the lines do not appear parallel

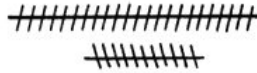

2

Note how one line appears longer



3

Note how the pipe appears bent under the arrow



4

Note that the boxes appear to be different sizes

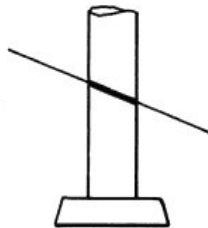

5

Note how the line appears thicker where it passes through the column

6

Note how quickly the figure disappears when you look directly at it

¹⁷⁹ <http://joyreactor.com/post/491308>

Only the assumption that the neuronal reconstruction of reality is *correct* provides an explanation for the fact that I can cross the street without injury; Not to mention that the constructivist argument itself indeed presupposes that our image of neurons is correct and annuls therefore its own prerequisite. It is a destructive cycle of almost ridiculous smallness.

We encounter phrases such as: "We are connected with the world not directly but only through neurons" or: "Consciousness is an online simulation". These are vain and empty words, signifying nothing. We *are* the neuronal system, provided that the term "neuronal system" is understood not only scientifically, but in its full metaphysical meaning. Thus we are directly connected with the environment, as well as any other entities.

Epistemological confidence. After so much criticism of doubt, I should now express my own views on the question of what we can recognize.

I regard the often used comparison appropriate, that our knowledge is comparable to the interior of a sphere whose surface forms the border to ignorance. However I see the sphere not in a Euclidean, but in a closed spherical space. Here, the maximum volume of the sphere is finite, and the volume of the region lying outside the sphere, which represents the non-knowledge, approaches finally zero.

So I am confident. Though the *calculability* is subject to narrow restrictions, I see no fundamental limit for our *understanding* – with the exception of that one, behind which lies what cannot be thought; but also there, nothing is hidden.

Thus the world is *recognizable*. I even think one could, if one were only smart enough, conclude the correct understanding and proper description of the world by pure – metaphysical, reasonable, logical and mathematical – thinking.

I myself am unable to do so, but the conclusions I have presented here justify this hypothesis – in particular through the way they have been conducted.

However, to know everything will fail just because of the sheer volume of facts. It is impossible to know all details of the evolutionary game of nature, from which life and mind arise. But it is quite possible to understand it in its fundamentals.

The same applies to the formation of a complex organism such as ours from the fertilized ovum. In this case, however, I am convinced that we are still far away from the knowledge of some basic principles.

I accept that if

- as a philosopher, one encounters problems which for centuries, if not even for thousands of years have remained unsolved, like the question "Why is there anything and not nothing?", or the seemingly irreparable contradiction between freedom and natural causality –
- or, as a physicist, one believes that the known physics describes only a small fraction of all that exists while the rest remains *dark*, or one believes in the reduction of the wave function –

then one tends to regard the basic questions as unanswerable, the understanding as limited *on principle*, and the space of the unknown as immensely large.

But I go by my own experience with knowledge, which I have summarized in this book.

It makes me optimistic.

Vienna, August 2011

Post Script

If THE TRUTH actually had stood on the old slip of paper that the little girl had found in the woods – now we know what would have been written on it:

Reality is woven from a single rule.

That, which weaves and is woven, does neither exist nor not-exist. Therefore it is necessary and with it that what it weaves: reality.

The weaving-rule is fact and law, individual and general at once.

It reads: the change of space is equal to the change of time.

It is a differential rule. Nothing follows from it alone, and therefore the future is open.

Everything which exists is a pattern of spacetime alterations.

Each pattern is caused and causative. It obeys the weaving-rule, and the rule obeys its form.

Through the unfolding of reality, new layers of being evolve, with new attributes and new rules. The known natural laws are such rules.

We too are patterns of spacetime alterations. We too obey rules. But we can change our rules. We are free.

The real thing differs from the described thing by its activity.

Activity changes in the evolution of being. It turns into sensation.

Probably we would not have understood it.

Correction

[On page 233 below](#) (in Section 2.5.), you find:

"Other than in the spherically symmetric case, however, the flow lines do not correspond to the paths of test-bodies in the Newtonian field, ..."

This is wrong. Also in the general case, the flow lines correspond to the paths of test-bodies in the Newtonian field.

This is exactly the point where my theory of gravitation separates from General Relativity. More about this can be found in my paper [Against Dark Matter - A New Theory of Gravitation](#) (in Section 5 on page 19ff).

